



CATÁLOGO TÉCNICO
2017

PERFIS ESPONJOSOS
**QUADRADOS E
RETANGULARES**

A	01
A	02
A	03
A	04
A	05
A	06
A	07
A	08
A	09
A	10
A	11
A	12
A	13
A	14
A	15
A	16
A	17
A	18

**TUBOS
ESPONJOSOS**

A	21
---	----

**REDONDOS
CORDÕES**

A	22
A	23

**ESPONJOSOS
DE USO GERAL**

A	22
A	23
A	24
A	25
A	26
A	27
A	28
A	29
A	30
A	31
A	32
A	33
A	34
A	35
A	36
A	37

**MACIÇOS
CORDÕES ORINGS**

B	01
B	02

MANGUEIRAS

B	03
B	04
B	05
B	06

**QUADRADOS
RETÂNGULARES
FITAS E CINTAS**

B	07
B	08
B	09
B	10
B	11
B	12
B	13
B	14
B	15

**USO GERAL E
PRÉ-MOLDADOS**

B	16
B	17
B	18
B	19
B	20
B	21
B	22
B	23
B	24
B	25
B	26

PERFIS MACIÇOS

B	27
B	28
B	29
B	30
B	31
B	32
B	33
B	34
B	35
B	36
B	37
B	38
B	39
B	40
B	41

**LINHA FURGÕES E
BANDÔ**

B	42
B	43
B	44
B	45
B	46
B	47
B	48
B	49
B	50
B	51
B	52
B	53
B	54

**PERFIL TIPO U
DE ACAMENTO**

C	01
C	02
C	03
C	04
C	05
C	06
C	07
C	08

**PERFIL P/
ESQUADRIAS**

C	09
C	10
C	11
C	12

P/ GUARNIÇÕES

D	01
D	02
D	03
D	04
D	05
D	06
D	07
D	08

**ARO RODAS
P/ ÔNIBUS**

D	09
---	----

SBR

-Borracha Estireno Butadieno

-Copolímero de Estireno Butadieno

Borracha com boa resistência à deformação (permanente à compressão). Possui ótima aderência a materiais rígidos. Quando exposta a intempéries (agentes de clima e luz solar) deve ser usada com precaução devido a sua baixa resistência. Não recomendado o seu uso em contato com altas temperaturas, óleos lubrificantes e fluídos a base de petróleo. Geralmente utilizada para vedações onde o contato será apenas com pó e água. Borracha de baixo custo para uso geral.

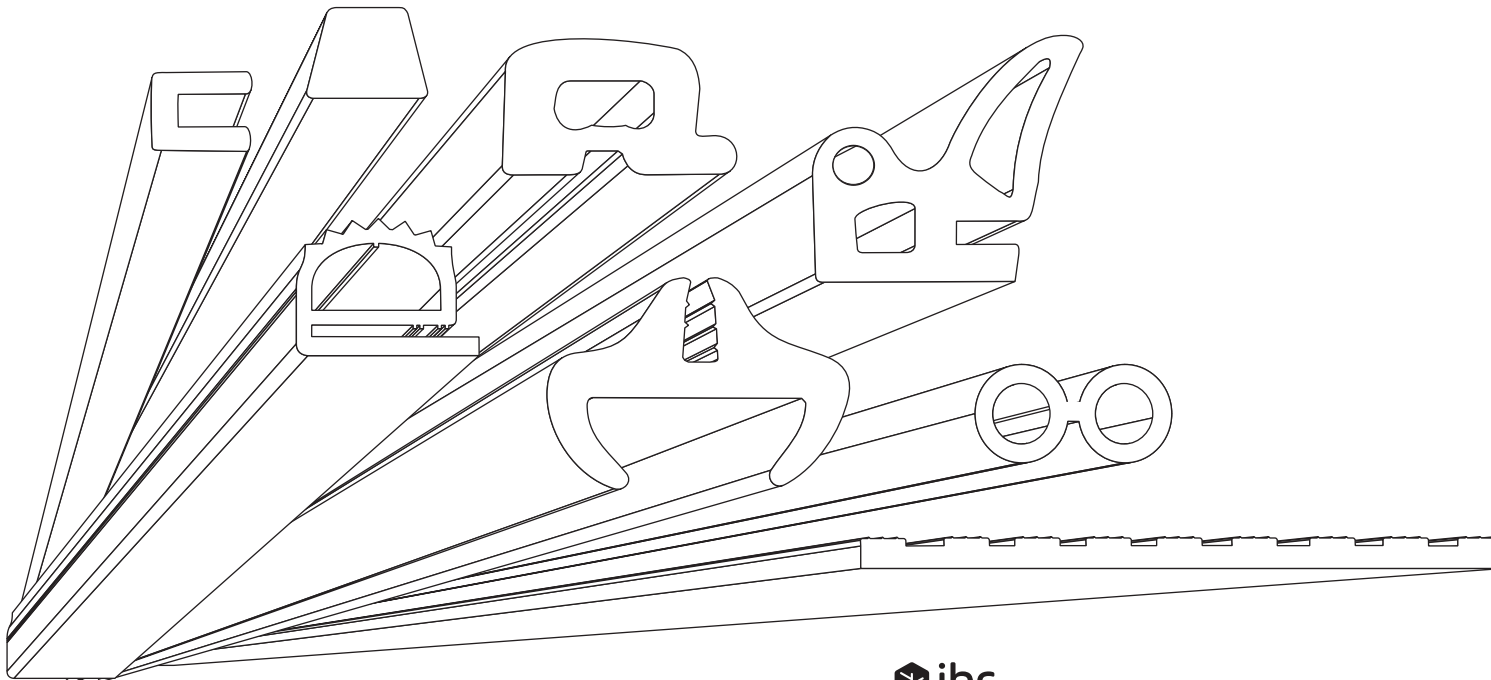

EPDM

-Terpolímero Etileno / Propileno Dieno

-Poli (Etileno Co Propileno)

Borracha com ótima resistência a intempéries (agentes de clima e luz solar), e a deformação (permanente à compressão). Excelente resistência aos ácidos e álcalis assim como soluções aquecidas de detergentes.

Apresentam também boa resistência a solventes oxigenados, fluidos hidráulicos e gorduras animais.

É uma das borrachas mais consumidas no mundo, em mangueiras, vedações para uso externo, como esponjados para carrocerias e portas, gaxetas de autoclaves e lavadoras com vapor e água quente com ou sem detergente e clareadores.

Bastante usada em frisos decorativos e de acabamento em móveis de uso externo e interno.

Não recomendado seu uso em contato com óleos lubrificantes e fluidos hidráulicos à base de petróleo.

Possui baixa resistência à chama, em condições normais.

Utilizada como guarnição de pára-brisas e janelas de ônibus, caminhões e veículos em geral.

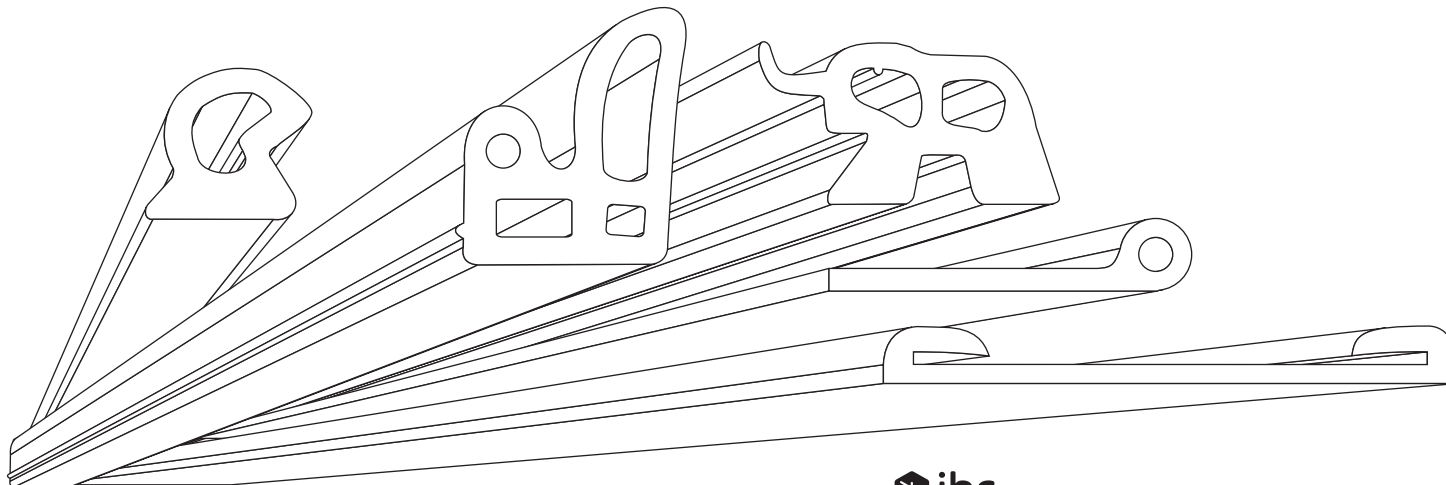

TIPOS DE ELASTÔMEROS

NBR (NITRÍLICA)

-Borracha Butadieno Nitrilo

-Poli (Buadieno Co-Acrilonitrilo)

Aplicações principais:

Mangueiras para solventes, óleos, graxas e combustíveis, mangueiras para gases, anéis, gaxetas e retentores.

Borracha com boa resistência à óleos e combustíveis, boa resistência a abrasão, baixa permeabilidade à gases, média resistência ao calor, resistência a solventes e média resistência a chamas.

Alguns tipos (com PVC) tem excelente resistência a intempéries (ozônio).

Largamente usada quando há contato constante com óleos, graxas, lubrificantes e combustíveis.

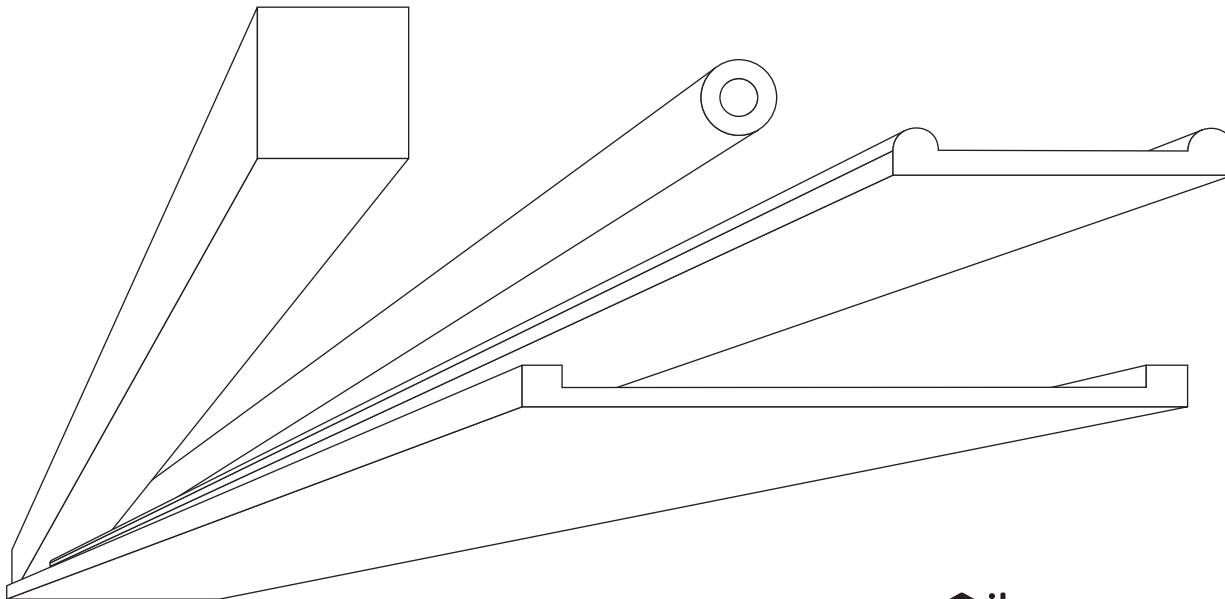

ÍNDICE

CÓDIGO	PÁGINA
LINHA 1000	
IBC 1001	A04
IBC 1002	A06
IBC 1003	A06
IBC 1004	A04
IBC 1005	A11
IBC 1006	A04
IBC 1007	A01
IBC 1008	A07
IBC 1009	A02
IBC 1010	A01
IBC 1011	A04
IBC 1012	A24
IBC 1013	A10
IBC 1014	A03
IBC 1015	A22
IBC 1016	A05
IBC 1017	A01
IBC 1018	A10
IBC 1019	A07
IBC 1020	A22
IBC 1021	A03
IBC 1022	A03
IBC 1023	A02
IBC 1024	A03
IBC 1025	A04
IBC 1026	A15
IBC 1027	A22
IBC 1028	A01
IBC 1029	A17
IBC 1031	A31
IBC 1032	A30
IBC 1033	A29

CÓDIGO	PÁGINA
IBC 1034	A32
IBC 1035	A24
IBC 1036	A06
IBC 1037	A06
IBC 1038	A22
IBC 1039	A30
IBC 1040	A23
IBC 1041	A22
IBC 1042	A03
IBC 1043	A03
IBC 1044	A08
IBC 1045	A11
IBC 1046	A11
IBC 1047	A15
IBC 1048	A08
IBC 1049	A06
IBC 1050	A09
IBC 1051	A02
IBC 1052	A05
IBC 1053	A06
IBC 1054	A09
IBC 1055	A10
IBC 1056	A10
IBC 1057	A12
IBC 1058	A03
IBC 1059	A06
IBC 1060	A05
IBC 1061	A07
IBC 1062	A10
IBC 1064	A25
IBC 1065	A25
IBC 1066	A24
IBC 1067	A31

CÓDIGO	PÁGINA
IBC 1068	A17
IBC 1069	A22
IBC 1070	A22
IBC 1071	A22
IBC 1073	A25
IBC 1074	A25
IBC 1075	A28
IBC 1076	A31
IBC 1077	A05
IBC 1078	A06
IBC 1079	A31
IBC 1080	A05
IBC 1081	A08
IBC 1084	A28
IBC 1085	A28
IBC 1086	A05
IBC 1087	A07
IBC 1088	A04
IBC 1089	A08
IBC 1090	A05
IBC 1091	A29
IBC 1092	A24
IBC 1093	A06
IBC 1094	A25
IBC 1095	A03
IBC 1096	A01
IBC 1097	A13
IBC 1098	A29
IBC 1099	A23
IBC 1100	A03
IBC 1101	A26
IBC 1102	A27
IBC 1103	A27

CÓDIGO	PÁGINA
IBC 1104	A34
IBC 1105	A34
IBC 1106	A34
IBC 1107	A34
IBC 1108	A33
IBC 1109	A25
IBC 1110	A03
IBC 1111	A27
IBC 1112	A32
IBC 1114	A07
IBC 1115	A03
IBC 1116	A04
IBC 1117	A05
IBC 1121	A02
IBC 1122	A03
IBC 1123	A02
IBC 1124	A08
IBC 1125	A26
IBC 1126	A34
IBC 1127	A01
IBC 1128	A25
IBC 1129	A34
IBC 1130	A33
IBC 1131	A08
IBC 1132	A08
IBC 1134	A05
IBC 1135	A09
IBC 1136	A24
IBC 1137	A33
IBC 1138	A10
IBC 1139	A01
IBC 1140	A10
IBC 1141	A27

CÓDIGO	PÁGINA	CÓDIGO	PÁGINA
IBC 1142	A27	IBC 1184	A35
IBC 1143	A27	IBC 1185	A28
IBC 1144	A34	IBC 1186	A24
IBC 1145	A25	IBC 1188	A34
IBC 1147	A22	IBC 1189	A33
IBC 1149	A24	IBC 1190	A04
IBC 1150	A30	IBC 1191	A36
IBC 1151	A18	IBC 1192	A07
IBC 1152	A26	IBC 1193	A34
IBC 1153	A23	IBC 1194	A33
IBC 1154	A12	IBC 1195	A33
IBC 1155	A28	IBC 1196	A27
IBC 1156	A11	IBC 1197	A23
IBC 1157	A13	IBC 1198	A24
IBC 1158	A13	IBC 1199	A17
IBC 1159	A02	IBC 1201	A06
IBC 1165	A28	IBC 1202	A08
IBC 1166	A27	IBC 1203	A33
IBC 1167	A01	IBC 1204	A22
IBC 1168	A01	IBC 1205	A24
IBC 1169	A34	IBC 1206	A23
IBC 1170	A28	IBC 1207	A37
IBC 1171	A34	IBC 1208	A33
IBC 1172	A26	IBC 1209	A04
IBC 1173	A30	IBC 1210	A24
IBC 1174	A31	IBC 1212	A18
IBC 1175	A23		
IBC 1176	A24		
IBC 1177	A33		
IBC 1178	A26		
IBC 1179	A26		
IBC 1181	A08		
IBC 1182	A03		

ÍNDICE

CÓDIGO	PÁGINA
IBC 1213	A19
IBC 1214	A19
IBC 1215	A24
IBC 1216	A12
IBC 1219	A32
IBC 1220	A12
IBC 1221	A36
IBC 1222	A24
IBC 1223	A31
IBC 1224	A30
IBC 1225	A02
IBC 1226	A08
IBC 1227	A22
IBC 1228	A16
IBC 1229	A04
IBC 1230	A11
IBC 1231	A10
IBC 1232	A13
IBC 1233	A29
IBC 1234	A37
IBC 1235	A07
IBC 1236	A09
IBC 1237	A12
IBC 1238	A26
IBC 1239	A22
IBC 1240	A06
IBC 1241	A14
IBC 1242	A01
IBC 1244	A23
IBC 1245	A23
IBC 1246	A35
IBC 1247	A26
IBC 1248	A12

CÓDIGO	PÁGINA
IBC 1249	A32
IBC 1250	A36
IBC 1251	A37
IBC 1252	A37
IBC 1253	A02
IBC 1254	A24
IBC 1255	A31
IBC 1256	A31
IBC 1258	A31
IBC 1260	A37
IBC 1262	A04
IBC 1263	A24
IBC 1264	A29
IBC 1265	A06
IBC 1266	A21
IBC 1267	A03
IBC 1268	A16
IBC 1269	A07
IBC 1270	A34
IBC 1271	A14
IBC 1272	A16
IBC 1273	A16
IBC 1275	A17
IBC 1276	A13
IBC 1277	A28
IBC 1278	A26
IBC 1279	A05
IBC 1280	A12
IBC 1281	A14
IBC 1282	A33
IBC 1283	A02
IBC 1284	A10
IBC 1285	A01

CÓDIGO	PÁGINA
IBC 1286	A08
IBC 1287	A08
IBC 1288	A04
IBC 1289	A13
IBC 1290	A14
IBC 1291	A18
IBC 1292	A08
IBC 1293	A14
IBC 1294	A19
IBC 1295	A26
IBC 1296	A10
IBC 1297	A36
IBC 1298	A19
IBC 1299	A35
IBC 1300	A30
IBC 1301	A36
IBC 1302	A36
IBC 1303	A28
IBC 1304	A06
IBC 1305	A07
IBC 1306	A05
IBC 1307	A02
IBC 1308	A24
IBC 1309	A17
IBC 1310	A22
IBC 1311	A23
IBC 1312	A23
IBC 1313	A35
IBC 1314	A37
IBC 1315	A21
IBC 1316	A21
IBC 1317	A31
IBC 1318	A32

CÓDIGO	PÁGINA
IBC 1319	A09
IBC 1320	A30
IBC 1321	A23
IBC 1322	A14
IBC 1323	A37
IBC 1324	A31
IBC 1325	A26
IBC 1326	A30
IBC 1327	A35
IBC 1328	A35
IBC 1329	A21
IBC 1330	A21
IBC 1331	A21
IBC 1332	A37
IBC 1333	A37
IBC 1334	A24
IBC 1337	A28
IBC 1339	A07
IBC 1340	A05
IBC 1341	A15
IBC 1342	A12
IBC 1343	A10
IBC 1344	A26
IBC 1345	A10
IBC 1346	A11
IBC 1347	A35
IBC 1348	A14
IBC 1349	A11
IBC 1350	A26
IBC 1351	A27
IBC 1352	A28
IBC 1353	A09
IBC 1354	A09

CÓDIGO	PÁGINA
IBC 1355	A05
IBC 1356	A08
IBC 1357	A27
IBC 1358	A15
IBC 1359	A30
IBC 1360	A29
IBC 1361	A02
IBC 1362	A08
IBC 1363	A10
IBC 1364	A08
IBC 1365	A17
IBC 1366	A29
IBC 1367	A30
IBC 1368	A23
IBC 1369	A36
IBC 1370	A02
IBC 1371	A24
IBC 1372	A25
IBC 1373	A29
IBC 1374	A33
IBC 1375	A25
IBC 1376	A35
IBC 1377	A15
IBC 1378	A05
IBC 1379	A11
IBC 1380	A02
IBC 1382	A34
IBC 1383	A03
IBC 1384	A04
IBC 1385	A06
IBC 1386	A07
IBC 1387	A10
IBC 1388	A01

CÓDIGO	PÁGINA
IBC 1389	A03
IBC 1390	A04
IBC 1391	A06
IBC 1392	A07
IBC 1393	A10
IBC 1394	A13
IBC 1395	A01
IBC 1396	A04
IBC 1397	A13
IBC 1398	A04
IBC 1399	A06
IBC 1400	A10
IBC 1401	A13
IBC 1402	A03
IBC 1403	A13
IBC 1404	A05
IBC 1405	A06
IBC 1406	A11
IBC 1407	A13
IBC 1408	A14
IBC 1409	A16
IBC 1410	A07
IBC 1411	A16
IBC 1412	A17
IBC 1413	A18
IBC 1414	A17
IBC 1415	A03
IBC 1416	A05
IBC 1417	A17
IBC 1418	A17
IBC 1419	A26
IBC 1420	A02

ÍNDICE

IBC 1426	A11
IBC 1427	A35
IBC 1428	A35
IBC 1429	A29
IBC 1430	A20
IBC 1431	A25
IBC 1432	A37
IBC 1433	A24
IBC 1434	A27
IBC 1435	A37
IBC 1436	A16
IBC 1437	A 04
IBC 1438	A02
IBC 1439	A19
IBC 1440	A29
IBC 1441	A06
IBC 1442	A26
IBC 1443	A32
IBC 1444	A32
IBC 1446	A34
IBC 1447	A21
IBC 1448	A21
IBC 1449	A21
IBC 1450	A02
IBC 1451	A31
IBC 1452	A30
IBC 1453	A24
IBC 1454	A10

IBC 1460	A15
IBC 1461	A13
IBC 1462	A21
IBC 1463	A08
IBC 1464	A11
IBC 1465	A01
IBC 1466	A24
IBC 1467	A35
IBC 1468	A17
IBC 1469	A31
IBC 1470	A24
IBC 1471	A11
IBC 1472	A21
IBC 1473	A19
IBC 1474	A18
IBC 1475	A03
IBC 1476	A09
IBC 1477	A26
IBC 1478	A23
IBC 1479	A35
IBC 1480	A31
IBC 1481	A18
IBC 1482	A09
IBC 1483	A30
IBC 1484	A32
IBC 1485	A30
IBC 1486	A08
IBC 1488	A10

IBC 1494	A11
IBC 1495	A15
IBC 1496	A15
IBC 1497	A16
IBC 1498	A18
IBC 1499	A18
IBC 1500	A19
IBC 1501	A09
IBC 1502	A11
IBC 1503	A27
IBC 1504	A27
IBC 1505	A05
IBC 1506	A06
IBC 1507	A08
IBC 1508	A10
IBC 1509	A13
IBC 1510	A06
IBC 1511	A29
IBC 1512	A26
IBC 1513	A31
IBC 1514	A32
IBC 1515	A07
IBC 1516	A20
IBC 1517	A25
IBC 1518	A29
IBC 1519	A15
IBC 1520	A15
IBC 1521	A15

IBC 1527	A15
IBC 1528	A10
IBC 1529	A16
IBC 1530	A17
IBC 1531	A18
IBC 1532	A19
IBC 1533	A17
IBC 1534	A15
IBC 1535	A27
IBC 1536	A30
IBC 1537	A02
IBC 1538	A26
IBC 1539	A30
IBC 1540	A33
IBC 1541	A27
IBC 1542	A35
IBC 1545	A08
IBC 1546	A06
IBC 1547	A26
IBC 1548	A22
IBC 1549	A22
IBC 1550	A22
IBC 1551	A22
IBC 1552	A22
IBC 1553	A14
IBC 1554	A16
IBC 1555	A25
IBC 1556	A20

IBC 1562	A25
IBC 1563	A35
IBC 1564	A26
IBC 1565	A03
IBC 1566	A05
IBC 1567	A08
IBC 1568	A37
IBC 1570	A37
IBC 1571	A21
IBC 1572	A27
IBC 1573	A30
IBC 1574	A31
IBC 1575	A20
IBC 1576	A26
IBC 1577	A01
IBC 1578	A29
IBC 1579	A01
IBC 1580	A31
IBC 1581	A20
IBC 1582	A08
IBC 1583	A32
IBC 1584	A32
IBC 1585	A01
IBC 1586	A16
IBC 1587	A20
IBC 1588	A17
IBC 1589	A21

IBC 1596	A27
IBC 1598	A05
IBC 1599	A28
IBC 1601	A19
IBC 1602	A17
IBC 1603	A12
IBC 1604	A04
IBC 1605	A30
IBC 1606	A26
IBC 1607	A25
IBC 1608	A30
IBC 1609	A32
IBC 1610	A32
IBC 1613	A12
IBC 1614	A07
IBC 1615	A07
IBC 1617	A04
IBC 1618	A03
IBC 1619	A07

ÍNDICE

CÓDIGO	PÁGINA	CÓDIGO	PÁGINA	CÓDIGO	PÁGINA	CÓDIGO	PÁGINA	CÓDIGO	PÁGINA	CÓDIGO	PÁGINA
LINHA 3000		IBC 3038	B43	IBC 3075	B19	IBC 3112	B01	IBC 3157	B03	IBC 3195	B24
IBC 3001	B17	IBC 3039	B16	IBC 3076	B10	IBC 3113	B09	IBC 3158	B01	IBC 3196	B16
IBC 3002	B10	IBC 3040	B16	IBC 3077	B10	IBC 3114	B03	IBC 3159	B52	IBC 3197	B04
IBC 3003	B34	IBC 3042	B09	IBC 3078	B08	IBC 3116	B02	IBC 3161	B21	IBC 3198	B25
IBC 3004	B01	IBC 3043	B09	IBC 3079	B38	IBC 3117	B27	IBC 3162	B07	IBC 3199	B17
IBC 3005	B09	IBC 3044	B09	IBC 3080	B26	IBC 3118	B35	IBC 3163	B08	IBC 3200	B02
IBC 3006	B11	IBC 3045	B52	IBC 3081	B18	IBC 3119	B19	IBC 3164	B08	IBC 3201	B16
IBC 3007	B16	IBC 3047	B03	IBC 3082	B09	IBC 3120	B16	IBC 3165	B07	IBC 3202	B21
IBC 3008	B24	IBC 3048	B51	IBC 3083	B14	IBC 3121	B09	IBC 3166	B08	IBC 3203	B09
IBC 3009	B19	IBC 3049	B51	IBC 3084	B23	IBC 3122	B14	IBC 3167	B08	IBC 3205	B53
IBC 3012	B06	IBC 3050	B49	IBC 3085	B07	IBC 3124	B05	IBC 3168	B01	IBC 3206	B21
IBC 3013	B07	IBC 3051	B14	IBC 3086	B19	IBC 3125	B05	IBC 3169	B13	IBC 3207	B40
IBC 3014	B07	IBC 3052	B23	IBC 3087	B17	IBC 3126	B05	IBC 3170	B05	IBC 3209	B28
IBC 3015	B07	IBC 3053	B07	IBC 3089	B05	IBC 3127	B05	IBC 3172	B23	IBC 3210	B28
IBC 3016	B07	IBC 3055	B52	IBC 3090	B20	IBC 3128	B42	IBC 3173	B23	IBC 3211	B28
IBC 3017	B07	IBC 3056	B15	IBC 3091	B11	IBC 3129	B18	IBC 3175	B03	IBC 3212	B04
IBC 3019	B01	IBC 3057	B03	IBC 3092	B02	IBC 3132	B24	IBC 3176	B15	IBC 3213	B16
IBC 3020	B01	IBC 3058	B03	IBC 3093	B44	IBC 3133	B03	IBC 3177	B05	IBC 3214	B24
IBC 3021	B01	IBC 3059	B03	IBC 3094	B01	IBC 3134	B03	IBC 3178	B01	IBC 3215	B07
IBC 3023	B01	IBC 3060	B03	IBC 3095	B04	IBC 3135	B37	IBC 3179	B02	IBC 3216	B15
IBC 3025	B01	IBC 3061	B03	IBC 3096	B05	IBC 3136	B38	IBC 3180	B02	IBC 3218	B05
IBC 3026	B01	IBC 3062	B03	IBC 3099	B02	IBC 3138	B06	IBC 3181	B02	IBC 3219	B03
IBC 3027	B01	IBC 3063	B20	IBC 3100	B42	IBC 3139	B47	IBC 3182	B02	IBC 3220	B23
IBC 3028	B01	IBC 3064	B24	IBC 3101	B19	IBC 3142	B01	IBC 3183	B24	IBC 3221	B25
IBC 3029	B01	IBC 3066	B03	IBC 3102	B19	IBC 3143	B18	IBC 3184	B36	IBC 3222	B11
IBC 3030	B07	IBC 3067	B03	IBC 3103	B19	IBC 3144	B16	IBC 3185	B17	IBC 3223	B43
IBC 3031	B08	IBC 3068	B17	IBC 3105	B04	IBC 3145	B26	IBC 3186	B15	IBC 3224	B23
IBC 3032	B09	IBC 3069	B21	IBC 3106	B38	IBC 3148	B44	IBC 3187	B18	IBC 3225	B24
IBC 3033	B14	IBC 3070	B21	IBC 3107	B43	IBC 3149	B26	IBC 3188	B03	IBC 3226	B22
IBC 3034	B13	IBC 3071	B22	IBC 3108	B05	IBC 3150	B54	IBC 3190	B24	IBC 3227	B28
IBC 3035	B06	IBC 3072	B21	IBC 3109	B06	IBC 3154	B26	IBC 3191	B26	IBC 3228	B24
IBC 3036	B24	IBC 3073	B07	IBC 3110	B04	IBC 3155	B03	IBC 3192	B15	IBC 3229	B28
IBC 3037	B43	IBC 3074	B10	IBC 3111	B14	IBC 3156	B15	IBC 3193	B17		

ÍNDICE

CÓDIGO	PÁGINA	CÓDIGO	PÁGINA	CÓDIGO	PÁGINA	CÓDIGO	PÁGINA	CÓDIGO	PÁGINA	CÓDIGO	PÁGINA
IBC 3230	B36	IBC 3264	B15	IBC 3299	B04	IBC 3333	B06	IBC 3373	B31	IBC 3408	B25
IBC 3231	B22	IBC 3265	B20	IBC 3300	B05	IBC 3334	B17	IBC 3374	B35	IBC 3409	B53
IBC 3232	B38	IBC 3266	B13	IBC 3301	B11	IBC 3335	B17	IBC 3375	B34	IBC 3410	B32
IBC 3233	B38	IBC 3267	B13	IBC 3302	B11	IBC 3337	B10	IBC 3376	B09	IBC 3411	B23
IBC 3234	B19	IBC 3268	B14	IBC 3303	B10	IBC 3338	B10	IBC 3377	B14	IBC 3412	B39
IBC 3235	B26	IBC 3269	B14	IBC 3304	B10	IBC 3339	B10	IBC 3378	B30	IBC 3413	B46
IBC 3236	B07	IBC 3270	B14	IBC 3305	B47	IBC 3340	B11	IBC 3379	B47	IBC 3414	B01
IBC 3237	B21	IBC 3271	B15	IBC 3306	B48	IBC 3341	B08	IBC 3380	B02	IBC 3415	B13
IBC 3238	B21	IBC 3272	B14	IBC 3307	B51	IBC 3342	B09	IBC 3381	B30	IBC 3416	B24
IBC 3239	B19	IBC 3273	B25	IBC 3308	B06	IBC 3343	B10	IBC 3382	B45	IBC 3417	B15
IBC 3240	B17	IBC 3274	B04	IBC 3309	B44	IBC 3344	B10	IBC 3383	B54	IBC 3418	B13
IBC 3241	B53	IBC 3275	B44	IBC 3310	B48	IBC 3345	B10	IBC 3384	B22	IBC 3419	B14
IBC 3242	B17	IBC 3276	B08	IBC 3311	B20	IBC 3346	B11	IBC 3385	B27	IBC 3420	B06
IBC 3244	B18	IBC 3277	B54	IBC 3312	B06	IBC 3349	B41	IBC 3386	B27	IBC 3421	B16
IBC 3245	B14	IBC 3278	B54	IBC 3313	B48	IBC 3350	B18	IBC 3387	B16	IBC 3422	B16
IBC 3246	B14	IBC 3279	B53	IBC 3314	B19	IBC 3351	B17	IBC 3388	B11	IBC 3423	B18
IBC 3247	B17	IBC 3280	B02	IBC 3315	B19	IBC 3352	B41	IBC 3389	B42	IBC 3424	B19
IBC 3248	B09	IBC 3281	B02	IBC 3316	B14	IBC 3353	B54	IBC 3390	B52	IBC 3425	B09
IBC 3249	B24	IBC 3282	B13	IBC 3317	B44	IBC 3354	B26	IBC 3392	B15	IBC 3426	B19
IBC 3250	B52	IBC 3283	B30	IBC 3318	B24	IBC 3355	B51	IBC 3393	B01	IBC 3427	B19
IBC 3251	B25	IBC 3285	B04	IBC 3319	B07	IBC 3357	B18	IBC 3394	B02	IBC 3428	B25
IBC 3252	B40	IBC 3286	B13	IBC 3320	B39	IBC 3358	B16	IBC 3395	B35	IBC 3429	B04
IBC 3253	B19	IBC 3287	B27	IBC 3322	B17	IBC 3359	B26	IBC 3396	B42	IBC 3430	B04
IBC 3254	B08	IBC 3288	B40	IBC 3323	B37	IBC 3360	B08	IBC 3397	B18	IBC 3431	B20
IBC 3255	B08	IBC 3289	B13	IBC 3324	B37	IBC 3361	B17	IBC 3398	B33	IBC 3432	B36
IBC 3256	B13	IBC 3290	B27	IBC 3325	B37	IBC 3362	B35	IBC 3399	B18	IBC 3433	B20
IBC 3257	B13	IBC 3291	B15	IBC 3326	B37	IBC 3363	B35	IBC 3400	B27	IBC 3434	B35
IBC 3258	B08	IBC 3293	B08	IBC 3327	B38	IBC 3367	B16	IBC 3401	B05	IBC 3435	B21
IBC 3259	B25	IBC 3294	B09	IBC 3328	B39	IBC 3368	B02	IBC 3403	B36	IBC 3436	B43
IBC 3260	B30	IBC 3295	B37	IBC 3329	B39	IBC 3369	B06	IBC 3404	B27	IBC 3437	B33
IBC 3261	B23	IBC 3296	B44	IBC 3330	B37	IBC 3370	B16	IBC 3405	B15	IBC 3438	B52
IBC 3262	B42	IBC 3297	B51	IBC 3331	B38	IBC 3371	B21	IBC 3406	B32	IBC 3439	B10
IBC 3263	B40	IBC 3298	B04	IBC 3332	B29	IBC 3372	B03	IBC 3407	B30	IBC 3440	B34

ÍNDICE

CÓDIGO	PÁGINA	CÓDIGO	PÁGINA	CÓDIGO	PÁGINA	CÓDIGO	PÁGINA	CÓDIGO	PÁGINA	CÓDIGO	PÁGINA
IBC 3441	B09	IBC 3474	B31	IBC 3511	B04	IBC 3546	B32	IBC 3580	B34	IBC 3615	B36
IBC 3442	B22	IBC 3475	B36	IBC 3512	B22	IBC 3547	B37	IBC 3581	B23	IBC 3616	B50
IBC 3443	B17	IBC 3476	B36	IBC 3513	B06	IBC 3548	B32	IBC 3582	B16	IBC 3617	B23
IBC 3444	B38	IBC 3477	B36	IBC 3514	B21	IBC 3549	B40	IBC 3583	B34	IBC 3618	B04
IBC 3445	B54	IBC 3478	B27	IBC 3515	B35	IBC 3550	B34	IBC 3584	B51	IBC 3619	B26
IBC 3446	B19	IBC 3479	B20	IBC 3516	B08	IBC 3551	B04	IBC 3585	B31	IBC 3620	B23
IBC 3447	B20	IBC 3480	B26	IBC 3517	B08	IBC 3552	B21	IBC 3586	B08	IBC 3621	B12
IBC 3448	B21	IBC 3481	B10	IBC 3518	B22	IBC 3553	B19	IBC 3587	B29	IBC 3622	B16
IBC 3449	B32	IBC 3482	B14	IBC 3519	B25	IBC 3554	B09	IBC 3588	B31	IBC 3623	B07
IBC 3450	B07	IBC 3484	B09	IBC 3520	B15	IBC 3555	B08	IBC 3589	B20	IBC 3624	B08
IBC 3451	B53	IBC 3485	B12	IBC 3521	B35	IBC 3556	B18	IBC 3590	B34	IBC 3625	B04
IBC 3452	B41	IBC 3486	B45	IBC 3522	B10	IBC 3557	B18	IBC 3591	B31	IBC 3626	B50
IBC 3453	B07	IBC 3487	B45	IBC 3523	B35	IBC 3558	B03	IBC 3592	B48	IBC 3627	B25
IBC 3454	B18	IBC 3488	B32	IBC 3524	B51	IBC 3559	B17	IBC 3593	B13	IBC 3628	B23
IBC 3455	B31	IBC 3489	B04	IBC 3525	B51	IBC 3560	B34	IBC 3594	B22	IBC 3629	B30
IBC 3456	B27	IBC 3490	B06	IBC 3526	B33	IBC 3561	B21	IBC 3595	B45	IBC 3630	B22
IBC 3457	B45	IBC 3491	B33	IBC 3527	B30	IBC 3562	B25	IBC 3596	B49	IBC 3631	B22
IBC 3458	B13	IBC 3492	B32	IBC 3528	B34	IBC 3563	B09	IBC 3597	B31	IBC 3632	B35
IBC 3459	B13	IBC 3493	B32	IBC 3529	B33	IBC 3564	B54	IBC 3598	B19	IBC 3633	B12
IBC 3460	B19	IBC 3494	B31	IBC 3531	B41	IBC 3565	B42	IBC 3599	B33	IBC 3634	B12
IBC 3461	B07	IBC 3495	B27	IBC 3532	B16	IBC 3566	B09	IBC 3600	B45	IBC 3635	B02
IBC 3462	B23	IBC 3496	B34	IBC 3533	B25	IBC 3567	B29	IBC 3601	B23	IBC 3636	B36
IBC 3463	B02	IBC 3497	B08	IBC 3534	B31	IBC 3568	B29	IBC 3602	B31	IBC 3637	B44
IBC 3464	B26	IBC 3498	B04	IBC 3535	B41	IBC 3569	B40	IBC 3603	B29	IBC 3638	B13
IBC 3465	B03	IBC 3499	B09	IBC 3536	B46	IBC 3570	B25	IBC 3604	B28	IBC 3639	B13
IBC 3466	B42	IBC 3500	B02	IBC 3537	B02	IBC 3571	B03	IBC 3605	B32	IBC 3640	B20
IBC 3467	B20	IBC 3501	B13	IBC 3538	B46	IBC 3572	B42	IBC 3606	B14	IBC 3641	B33
IBC 3468	B15	IBC 3502	B15	IBC 3540	B27	IBC 3573	B25	IBC 3607	B04	IBC 3642	B33
IBC 3469	B20	IBC 3506	B18	IBC 3541	B04	IBC 3575	B18	IBC 3608	B28	IBC 3643	B33
IBC 3470	B27	IBC 3507	B03	IBC 3542	B34	IBC 3576	B08	IBC 3609	B21	IBC 3644	B39
IBC 3471	B49	IBC 3508	B34	IBC 3543	B28	IBC 3577	B04	IBC 3610	B42	IBC 3645	B16
IBC 3472	B04	IBC 3509	B48	IBC 3544	B22	IBC 3578	B53	IBC 3613	B22	IBC 3646	B30
IBC 3473	B34	IBC 3510	B25	IBC 3545	B52	IBC 3579	B08	IBC 3614	B30		

ÍNDICE

CÓDIGO	PÁGINA	CÓDIGO	PÁGINA	CÓDIGO	PÁGINA	CÓDIGO	PÁGINA	CÓDIGO	PÁGINA
IBC 3647	B34	IBC 3681	B09						
IBC 3648	B29								
IBC 3649	B29								
IBC 3650	B50								
IBC 3651	B34								
IBC 3652	B41								
IBC 3653	B33								
IBC 3654	B29								
IBC 3655	B24								
IBC 3656	B36								
IBC 3657	B30								
IBC 3658	B25								
IBC 3659	B32								
IBC 3660	B29								
IBC 3661	B43								
IBC 3662	B30								
IBC 3663	B36								
IBC 3664	B31								
IBC 3665	B04								
IBC 3666	B43								
IBC 3667	B52								
IBC 3668	B30								
IBC 3669	B25								
IBC 3670	B43								
IBC 3671	B05								
IBC 3672	B05								
IBC 3673	B52								
IBC 3674	B24								
IBC 3675	B12								
IBC 3676	B29								
IBC 3677	B21								
IBC 3679	B35								
IBC 3680	B15								

ÍNDICE

CÓDIGO	PÁGINA
LINHA 5000	
IBC 5001	C09
IBC 5002	C03
IBC 5003	C09
IBC 5004	C10
IBC 5005	C03
IBC 5006	C09
IBC 5007	C10
IBC 5008	C10
IBC 5009	C02
IBC 5010	C04
IBC 5011	C05
IBC 5012	C03
IBC 5013	C01
IBC 5014	C10
IBC 5015	C06
IBC 5016	C01
IBC 5017	C10
IBC 5018	C03
IBC 5019	C03
IBC 5020	C05
IBC 5021	C05
IBC 5022	C01
IBC 5023	C01
IBC 5024	C01
IBC 5025	C01
IBC 5026	C03
IBC 5027	C03
IBC 5028	C02
IBC 5031	C05
IBC 5032	C09
IBC 5033	C09
IBC 5034	C09

CÓDIGO	PÁGINA
IBC 5035	C07
IBC 5036	C03
IBC 5037	C04
IBC 5038	C04
IBC 5039	C04
IBC 5040	C04
IBC 5041	C02
IBC 5042	C04
IBC 5043	C01
IBC 5044	C06
IBC 5045	C04
IBC 5046	C04
IBC 5047	C06
IBC 5048	C08
IBC 5049	C10
IBC 5050	C05
IBC 5051	C04
IBC 5052	C05
IBC 5053	C06
IBC 5054	C01
IBC 5055	C03
IBC 5056	C04
IBC 5057	C06
IBC 5058	C02
IBC 5059	C08
IBC 5060	C08
IBC 5061	C11
IBC 5062	C01
IBC 5063	C06
IBC 5064	C10
IBC 5065	C02
IBC 5066	C02
IBC 5068	C01

CÓDIGO	PÁGINA
IBC 5069	C01
IBC 5070	C02
IBC 5071	C04
IBC 5072	C02
IBC 5073	C06
IBC 5074	C03
IBC 5076	C02
IBC 5077	C06
IBC 5079	C11
IBC 5080	C03
IBC 5081	C02
IBC 5082	C04
IBC 5083	C04
IBC 5084	C01
IBC 5085	C06
IBC 5087	C07
IBC 5088	C10
IBC 5089	C10
IBC 5090	C12
IBC 5091	C12
IBC 5092	C09
IBC 5093	C11
IBC 5094	C08
IBC 5095	C12
IBC 5096	C01
IBC 5097	C04
IBC 5098	C02
IBC 5099	C09
IBC 5100	C09
IBC 5101	C09
IBC 5102	C09
IBC 5103	C07
IBC 5104	C07

CÓDIGO	PÁGINA
IBC 5105	C07
IBC 5106	C06
IBC 5107	C02
IBC 5108	C07
IBC 5109	C03
IBC 5110	C10
IBC 5111	C10
IBC 5112	C06
IBC 5113	C06
IBC 5115	C07
IBC 5116	C03
IBC 5117	C12
IBC 5118	C12
IBC 5119	C07
IBC 5120	C08
IBC 5121	C08
IBC 5122	C08
IBC 5123	C07
IBC 5124	C09
IBC 5125	C09
IBC 5126	C04
IBC 5127	C09
IBC 5128	C01
IBC 5129	C07
IBC 5130	C10
IBC 5131	C01
IBC 5132	C11
IBC 5133	C11
IBC 5134	C11
IBC 5135	C11
IBC 5136	C03
IBC 5137	C09
IBC 5138	C07

CÓDIGO	PÁGINA
IBC 5139	C05
IBC 5140	C05
IBC 5141	C03
IBC 5142	C09
IBC 5143	C03
IBC 5144	C11
IBC 5145	C05
IBC 5146	C05
IBC 5147	C05
IBC 5148	C05
IBC 5149	C09
IBC 5150	C09
IBC 5151	C03
IBC 5152	C01
IBC 5153	C04
IBC 5154	C04
IBC 5155	C06
IBC 5156	C06
IBC 5157	C07
IBC 5158	C01
IBC 5159	C08
IBC 5160	C06
IBC 5161	C02
IBC 5162	C11
IBC 5163	C02
IBC 5164	C04
IBC 5165	C04
IBC 5166	C07
IBC 5167	C05
IBC 5168	C05
IBC 5169	C05
IBC 5170	C11
IBC 5171	C04

CÓDIGO	PÁGINA
IBC 5172	C05
IBC 5173	C07
IBC 5174	C03
IBC 5175	C02
IBC 5176	C09
IBC 5177	C05
IBC 5179	C02
IBC 5180	C07
IBC 5181	C07
IBC 5183	C03
IBC 5184	C03

TABELA DE PROPRIEDADES FÍSICO MECÂNICAS E QUÍMICAS

ELASTÔMEROS		NATURAL NR	SBR	EPDM	NITRILICA NBR	NEOPRENE CR	SILICONE
FAIXA DE DUREZA (SHORE A)	MACIÇOS	30 - 100	35 - 90	40 - 90	40 - 100	40 - 90	35 - 90
	ESPONJOSOS	10 - 30	10 - 30	10 - 30	10 - 30	10 - 30	—
TENSÃO DE RUPTURA MÉDIA (kg/cm ²)		200	120	100	120	150	70
ALONGAMENTO MÁXIMO NA RUPTURA		800	600	600	650	600	800
RESISTÊNCIA AO RASGAMENTO		O	R	R	R	O	R - B
DEFORM. PERMAN. À COMPRESSÃO		O	B	R	R	B	R
RESISTÊNCIA À ABRASÃO		O	R - B	B	B	O	R
RESISTÊNCIA AO IMPACTO		O	B	B	R	B	NA
RESISTÊNCIA À FLEXÃO		O	B	R	R	O	B
IMPERMEABILIDADE À GASES		O	R	R	R	B	R
RESISTÊNCIA AO INTEMPERISMO		NA	R	O	R	O	O
RESISTÊNCIA À OXIDAÇÃO		R	R	O	B	O	O
RESISTÊNCIA AO OZÔNIO		R	R	O	R	O	O
RESISTÊNCIA À CHAMA		R	R	R	R	O	R
TEMPERATURAS DE TRABALHO (°C)	MÁXIMA	70	70	150	130	100	250
	MÍNIMA	-20	-20	-35	-15	-10	-80
RES. À ÓLEOS MINER. E SOLVENTES		NA	NA	NA	O	B	NA
RES. À ÓLEOS VEGETAL E ANIMAL		R	R	B	O	B	O
RESISTÊNCIA AOS ÁCIDOS		R	R	O	R	B	B
RESISTÊNCIA AOS ÁLCALIS		B	R	O	R	B	B

LEGENDA







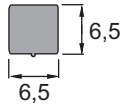

O = Ótimo
B = Bom
R = Regular
NA = Não Aplicável

TABELA DE TOLERÂNCIAS

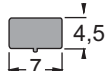

COTA mm	COTA (mm)	até 5	6 a 10	11 a 15	16 a 20	21 a 30	31 a 50	51 a 80	81 a 120	121 a 180
MACIÇA	MACIÇA	± 0,2	± 0,3	± 0,4	± 0,5	± 0,7	± 1,0	± 1,2	± 1,4	± 1,6
ESPONJA	ESPONJA	± 0,3	± 0,4	± 0,5	± 0,8	± 1,0	± 1,5	± 2,0	± 2,5	± 3,0

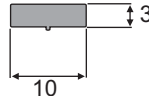
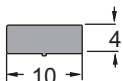

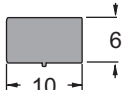
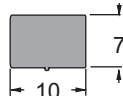
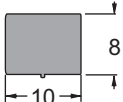
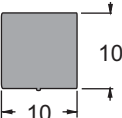
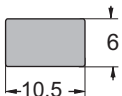



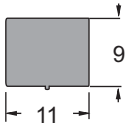
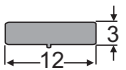

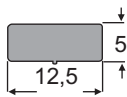
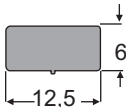
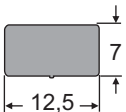
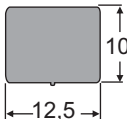
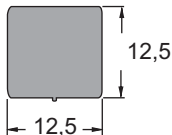
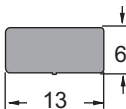
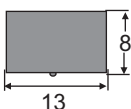
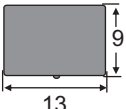
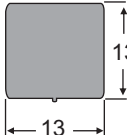
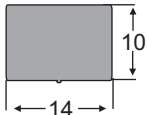
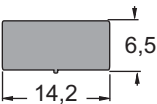



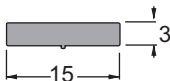

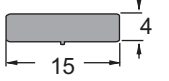
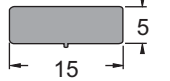
PERFIS ESPONJOSOS

<p>IBC 1424 SBR 15 Sh A</p>  <p>Rolo 100 m</p>	<p>IBC 1010 SBR 10 Sh A IBC 1465 EPDM 10 Sh A</p>  <p>Rolo 100 m</p>	<p>IBC 1423 SBR 15 Sh IBC 1577 EPDM 15 Sh.</p>  <p>Rolo 100 m</p>	<p>IBC 1028 SBR 10 Sh A</p>  <p>Rolo 100 m</p>
<p>IBC1096 SBR 10 Sh A</p>  <p>Rolo 100 m</p>	<p>IBC 1168 SBR 10 Sh A IBC 1585 EPDM 10 Sh A</p>  <p>Rolo 100 m</p>	<p>IBC 1139 SBR 10 Sh A</p>  <p>Rolo 100 m</p>	<p>IBC 1285 SBR 15 Sh A</p>  <p>Rolo 100 m</p>
<p>IBC 1388 EPDM 10 Sh A</p>  <p>Rolo 100 m</p>	<p>IBC 1395 SBR 10 Sh A</p>  <p>Rolo 100 m</p>	<p>IBC 1007 SBR 10 Sh A</p>  <p>Rolo 100 m</p>	<p>IBC 1017 SBR 10 Sh A IBC 1242 EPDM 10 Sh A</p>  <p>Rolo 100 m</p>
<p>IBC 1127 SBR 10 Sh A</p>  <p>Rolo 100 m</p>	<p>IBC 1167 SBR 10 Sh A</p>  <p>Rolo 50 m</p>	<p>IBC 1579 EPDM 15 Sh A</p>  <p>Rolo 100 m</p>	<p>ITEM NOVO</p>

* ITEM NOVO

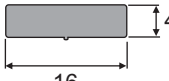
<p>IBC 1159 SBR 10 Sh A</p>  <p>Rolo 100 m</p>	<p>IBC1121 SBR 10 Sh A</p>  <p>Rolo 100 m</p>	<p>IBC 1307 SBR 10 Sh A</p>  <p>Rolo 100 m</p>	<p>IBC 1023 SBR 10 Sh A</p>  <p>Rolo 100 m</p>
<p>IBC 1420 SBR 10 Sh A IBC 1450 EPDM 10 Sh A</p>  <p>Rolo 100 m</p>	<p>IBC 1380 SBR 10 Sh A</p>  <p>Rolo 100 m</p>	<p>IBC 1009 SBR 10 Sh A</p>  <p>Rolo 50 m</p>	<p>IBC 1123 SBR 10 Sh A IBC 1253 SBR 15 Sh A IBC 1370 SBR 25 Sh A</p>  <p>Rolo 50 m</p>
<p>IBC 1283 SBR 10 Sh A</p>  <p>Rolo 100 m</p>	<p>IBC 1537 EPDM 10 Sh A</p>  <p>Rolo 100 m</p>	<p>IBC 1438 SBR 10 Sh A</p>  <p>Rolo 50 m</p>	<p>IBC 1225 SBR 10 Sh A</p>  <p>Rolo 50 m</p>
<p>IBC 1361 SBR 10 Sh A</p>  <p>Rolo 50 m</p>	<p>IBC 1051 SBR 10 Sh A</p>  <p>Rolo 100 m</p>		







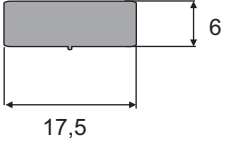
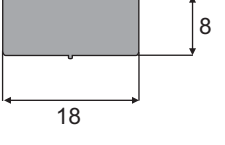
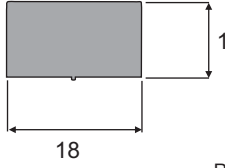
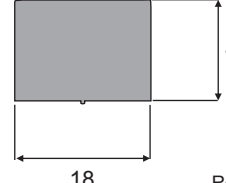
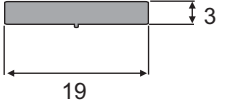
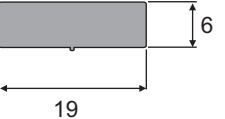
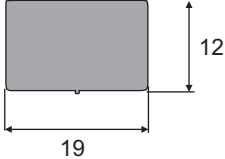
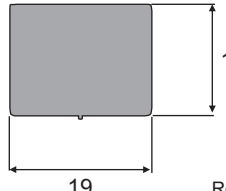
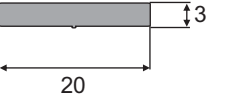
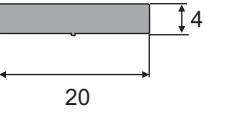
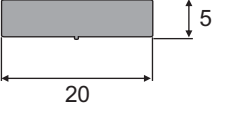
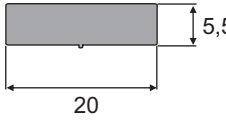
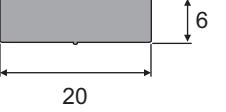
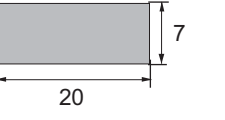
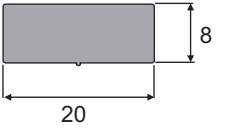

* ITEM NOVO

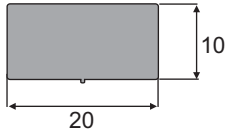
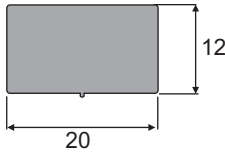
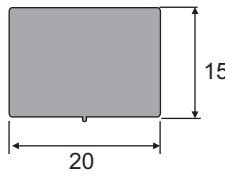
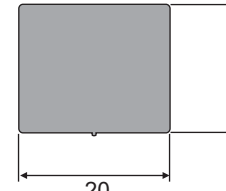
<p>IBC 1383 SBR 10 Sh A</p>  <p>Rolo 100 m</p>	<p>IBC 1110 SBR 10 Sh A</p>  <p>Rolo 100 m</p>	<p>IBC 1389 SBR 10 Sh A</p>  <p>Rolo 100 m</p>	<p>IBC 1014 SBR 10 Sh A</p>  <p>Rolo 100 m</p>
<p>IBC 1095 SBR 10 Sh A IBC 1100 EPDM 10 Sh A</p>  <p>Rolo 100 m</p>	<p>IBC 1021 SBR 10 Sh A IBC 1565 SBR 20 Sh A</p>  <p>Rolo 100 m</p>	<p>IBC 1402 SBR 10 Sh A</p>  <p>Rolo 50 m</p>	<p>IBC 1415 SBR 10 Sh A</p>  <p>Rolo 50 m</p>
<p>IBC 1115 SBR 10 Sh A</p>  <p>Rolo 50 m</p>	<p>IBC 1043 SBR 10 Sh A IBC 1182 EPDM 10 Sh A</p>  <p>Rolo 50 m</p>	<p>IBC 1024 SBR 10 Sh A</p>  <p>Rolo 100 m</p>	<p>IBC 1122 SBR 10 Sh A IBC 1475 EPDM 10 Sh A</p>  <p>Rolo 100 m</p>
<p>IBC 1022 SBR 10 Sh A IBC 1267 EPDM 10 Sh A</p>  <p>Rolo 50 m</p>	<p>IBC 1042 SBR 10 Sh A</p>  <p>Rolo 50 m</p>	<p>IBC 1058 SBR 10 Sh A IBC 1618 EPDM 10 Sh A</p>  <p>Rolo 50 m</p>	<p>* ITEM NOVO</p>

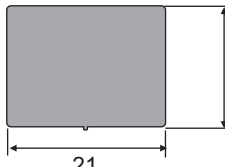
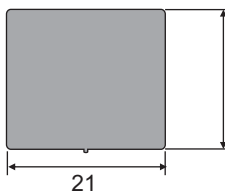

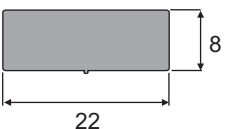
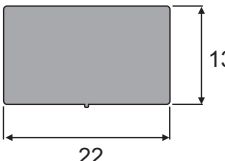
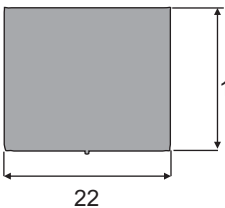

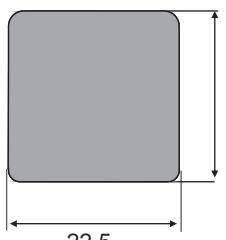
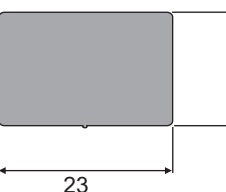
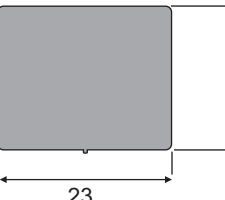

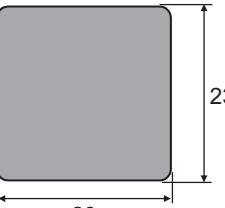

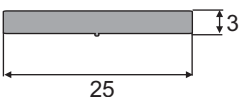
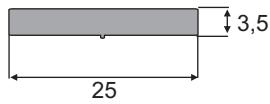
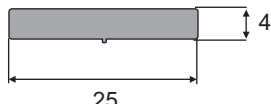
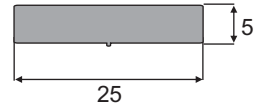
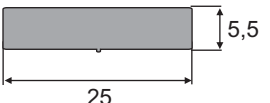

*** ITEM NOVO**

<p>IBC 1262 EPDM 10 Sh A</p>  <p>17,5</p> <p>Rolo 50 m</p>	<p>IBC 1088 SBR 10 Sh A</p>  <p>18</p> <p>Rolo 50 m</p>	<p>IBC 1006 SBR 10 Sh A IBC 1437 EPDM 15 Sh A</p>  <p>18</p> <p>Rolo 50 m</p>	<p>IBC 1001 SBR 10 Sh A IBC 1229 EPDM 10 Sh A</p>  <p>18</p> <p>Rolo 50 m</p>
<p>IBC 1288 SBR 15 Sh A</p>  <p>19</p> <p>Rolo 100 m</p>	<p>IBC 1004 SBR 10 Sh A IBC 1190 EPDM 10 Sh A</p>  <p>19</p> <p>Rolo 50 m</p>	<p>IBC 1209 SBR 10 Sh A</p>  <p>19</p> <p>Rolo 50 m</p>	<p>IBC 1025 SBR 10 Sh A</p>  <p>19</p> <p>Rolo 50 m</p>
<p>IBC 1384 SBR 10 Sh A</p>  <p>20</p> <p>Rolo 100 m</p>	<p>IBC 1390 SBR 10 Sh A</p>  <p>20</p> <p>Rolo 50 m</p>	<p>IBC 1396 SBR 10 Sh A</p>  <p>20</p> <p>Rolo 50 m</p>	<p>IBC 1011 SBR 10 Sh A IBC 1011 SBR 10 Sh A</p>  <p>20</p> <p>Rolo 50 m</p>
<p>IBC 1398 SBR 10 Sh A</p>  <p>20</p> <p>Rolo 50 m</p>	<p>IBC 1604 EPDM 10 Sh A</p>  <p>20</p> <p>Rolo 50 m</p>	<p>IBC 1116 SBR 10 Sh A</p>  <p>20</p> <p>Rolo 50 m</p>	<p>* ITEM NOVO</p>

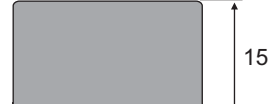

* ITEM NOVO

IBC 1117 SBR 10 Sh A IBC 1080 SBR 20 Sh A IBC 1505 EPDM 10 Sh A  Rolo 50 m	IBC 1416 SBR 10 Sh A  Rolo 50 m	IBC 1404 SBR 10 Sh A  Rolo 50 m	IBC 1077 SBR 10 Sh A  Rolo 25 m
IBC 1090 SBR 10 Sh A IBC 1378 EPDM 15 Sh A  Rolo 25 m	IBC 1306 EPDM 10 Sh A  Rolo 25 m	IBC 1016 SBR 10 Sh A  Rolo 25 m	IBC 1134 SBR 10 Sh A  Rolo 50 m
IBC 1052 SBR 10 Sh A  Rolo 50 m	IBC 1279 SBR 10 Sh A  Rolo 50 m	IBC 1060 SBR 10 Sh A IBC 1340 EPDM 10 Sh A  Rolo 25 m	IBC 1566 SBR 10 Sh A   Rolo 25 m
IBC 1355 SBR 10 Sh A  Rolo 25 m	IBC 1086 SBR 10 Sh A  Rolo 25 m	IBC 1598 EPDM 10 Sh A   Rolo 25 m	





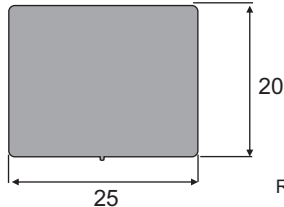
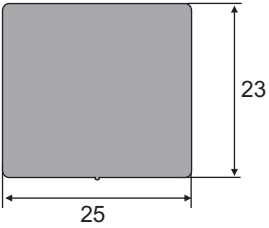
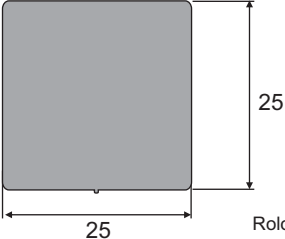
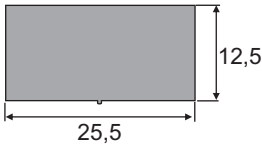
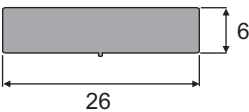
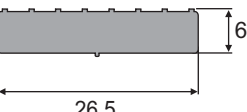
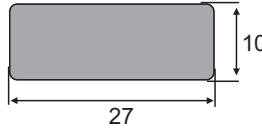
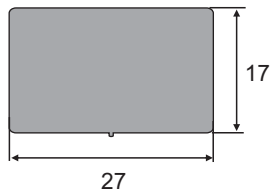

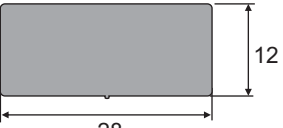
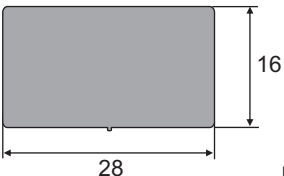
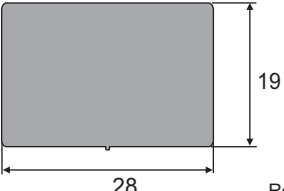
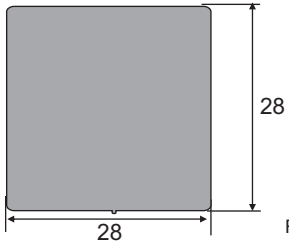
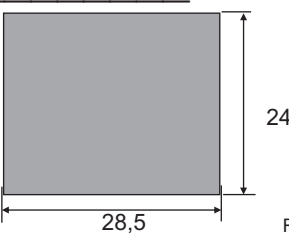
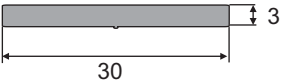
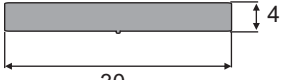

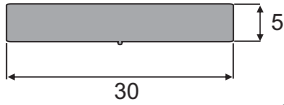
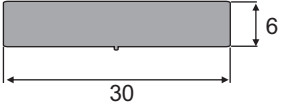

ITEM NOVO

<p>IBC 1385 SBR 10 Sh A</p>  <p>Rolo 50 m</p>	<p>IBC 1049 SBR 10 Sh A</p>  <p>Rolo 50 m</p>	<p>IBC 1265 EPDM 10 Sh A IBC 1391 SBR 10 Sh A</p>  <p>Rolo 50 m</p>	<p>IBC 1036 SBR 10 Sh A IBC 1510 EPDM 10 Sh A</p>  <p>Rolo 50 m</p>
<p>IBC 1053 SBR 10 Sh A IBC 1078 EPDM 10 Sh A</p>  <p>Rolo 50 m</p>	<p>IBC 1399 SBR 10 Sh A</p>  <p>Rolo 50 m</p>	<p>IBC 1037 SBR 10 Sh A IBC 1201 EPDM 10 Sh A</p>  <p>Rolo 50 m</p>	<p>IBC 1304 SBR 10 Sh A</p>  <p>Rolo 50 m</p>
<p>IBC 1240 SBR 10 Sh A IBC 1506 EPDM 10 Sh A</p>  <p>Rolo 50 m</p>	<p>IBC 1059 SBR 10 Sh A</p>  <p>Rolo 50 m</p>	<p>IBC 1002 SBR 10 Sh A</p>  <p>Rolo 50 m</p>	<p>IBC 1405 SBR 10 Sh A IBC 1546 EPDM 10 Sh A</p>  <p>Rolo 25 m</p>
<p>IBC 1093 SBR 10 Sh A</p>  <p>Rolo 25 m</p>	<p>IBC 1003 SBR 10 Sh A</p>  <p>Rolo 25 m</p>	<p>IBC 1441 EPDM 10 Sh A</p>  <p>Rolo 25 m</p>	

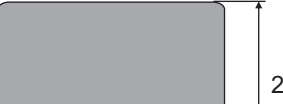
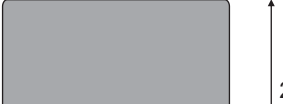
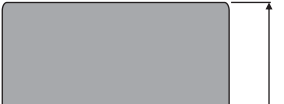
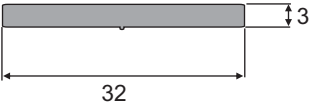
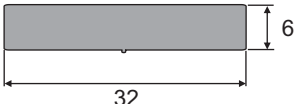
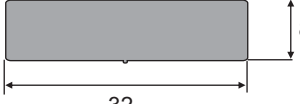
* ITEM NOVO



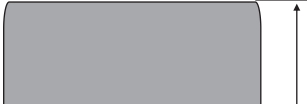



<p>IBC 1019 SBR 10 Sh A IBC 1192 EPDM 10 Sh A IBC 1410 SBR 15 Sh A</p>  <p>Rolo 25 m</p>	<p>IBC 1235 SBR 10 Sh A</p>  <p>Rolo 25 m</p>	<p>IBC 1114 SBR 10 Sh A</p>  <p>Rolo 25 m</p>	<p>IBC 1339 EPDM 10 Sh A</p>  <p>Rolo 50 m</p>
<p>IBC 1087 SBR 10 Sh A IBC 1619 EPDM 10 Sh A</p>  <p>Rolo 50 m</p>	<p>IBC 1269 EPDM 20 Sh A</p>  <p>Rolo 50 m</p>	<p>IBC 1614 SBR 10 Sh A</p>  <p>Rolo 50 m</p>	<p>IBC 1515 SBR 10 Sh A</p>  <p>Rolo 25 m</p>
<p>IBC 1615 SBR 10 Sh A</p>  <p>Rolo 50 m</p>	<p>IBC 1493 SBR 10 Sh A</p>  <p>Rolo 25 m</p>	<p>IBC 1305 EPDM 10 Sh A</p>  <p>Rolo 25 m</p>	<p>IBC 1008 SBR 10 Sh A</p>  <p>Rolo 25 m</p>
<p>IBC 1061 SBR 10 Sh A</p>  <p>Rolo 25 m</p>	<p>IBC 1591 EPDM 10 Sh A</p>  <p>Rolo 25 m</p>	<p>IBC 1386 SBR 10 Sh A</p>  <p>Rolo 50 m</p>	<p>IBC 1392 SBR 10 Sh A</p>  <p>Rolo 50 m</p>

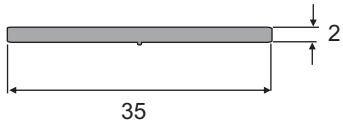
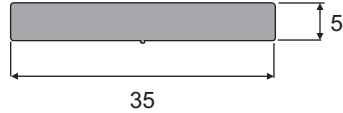
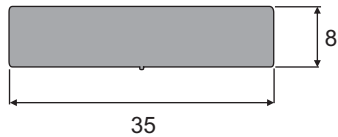
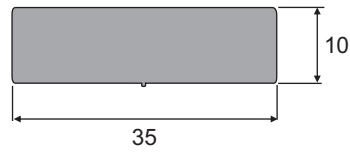
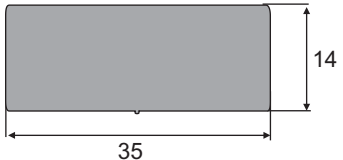
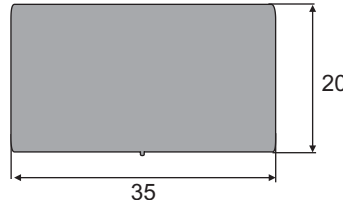
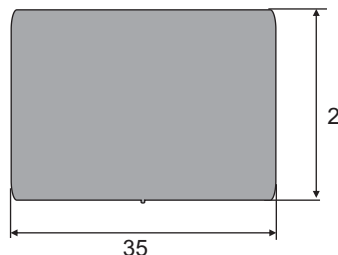
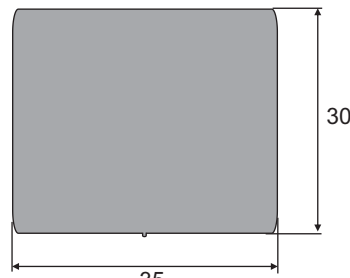
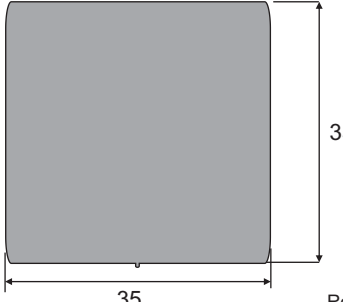
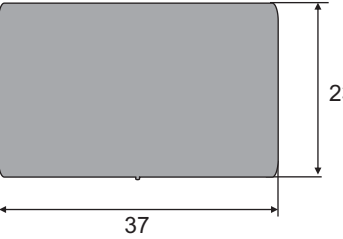
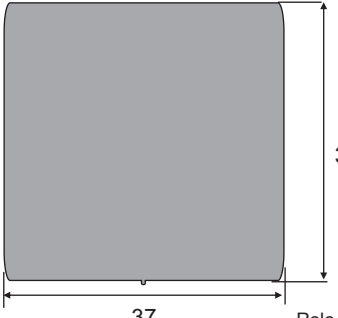
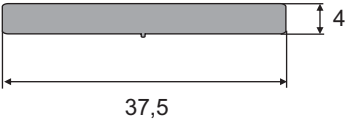

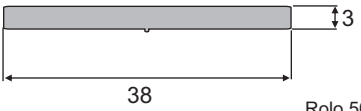
* ITEM NOVO

<p>IBC 1131 SBR 10 Sh A IBC 1545 EPDM 10 Sh A</p>  <p>Rolo 50 m</p>	<p>IBC 1132 SBR 10 Sh A</p>  <p>Rolo 50 m</p>	<p>IBC 1181 SBR 10 Sh A IBC 1507 EPDM 10 Sh A</p>  <p>Rolo 25 m</p>	<p>IBC 1567 SBR 10 Sh A</p>  <p>Rolo 25 m</p>
<p>IBC 1089 SBR 10 Sh A IBC 1582 EPDM 10 Sh A</p>  <p>Rolo 25 m</p>	<p>IBC 1226 SBR 10 Sh A</p>  <p>Rolo 25 m</p>	<p>IBC 1124 SBR 10 Sh A IBC 1202 EPDM 10 Sh A</p>  <p>Rolo 25 m</p>	<p>IBC 1081 SBR 10 Sh A IBC 1486 EPDM 10 Sh A</p>  <p>Rolo 25 m</p>
<p>IBC 1287 SBR 15 Sh A</p>  <p>Rolo 50 m</p>	<p>IBC 1048 SBR 10 Sh A</p>  <p>Rolo 50 m</p>	<p>IBC 1286 SBR 10 Sh A</p>  <p>Rolo 25 m</p>	<p>IBC 1044 SBR 10 Sh A</p>  <p>Rolo 25 m</p>
<p>IBC 1292 SBR 10 Sh A</p>  <p>Rolo 25 m</p>	<p>IBC 1362 SBR 10 Sh A IBC 1364 EPDM 10 Sh A</p>  <p>Rolo 25 m</p>	<p>IBC 1463 SBR 15 Sh A</p>  <p>Rolo 25 m</p>	<p>IBC 1356 SBR 10 Sh A</p>  <p>Rolo 25 m</p>

* ITEM NOVO

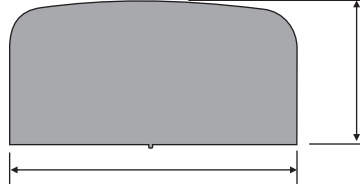
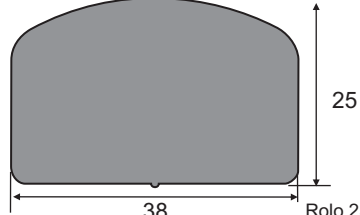
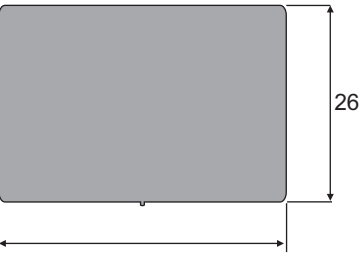
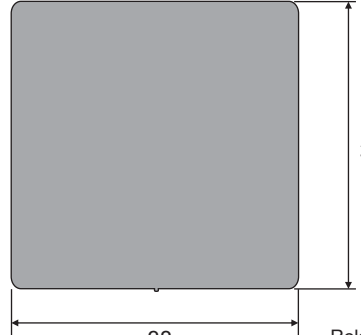
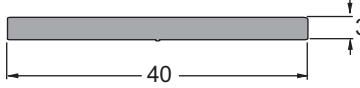
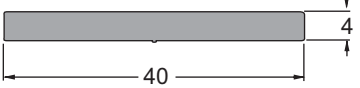
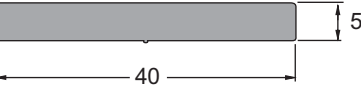
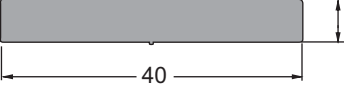
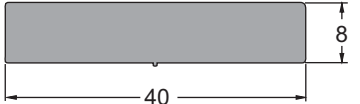
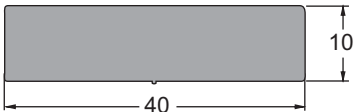

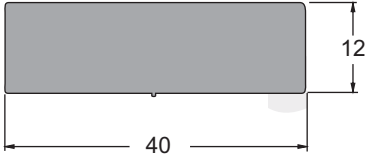

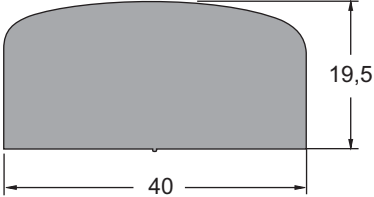
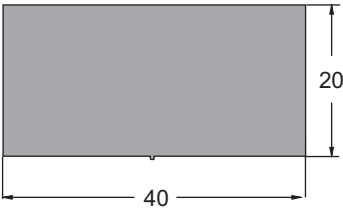
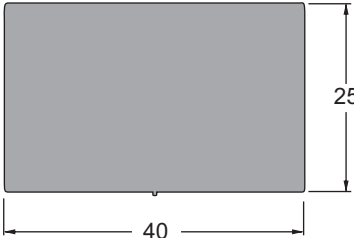
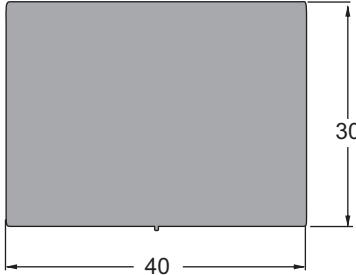
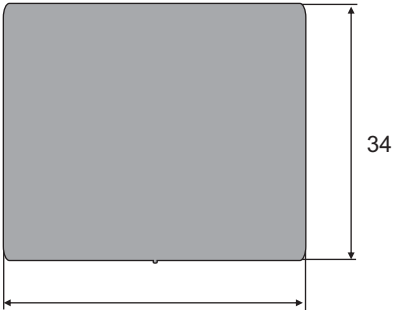
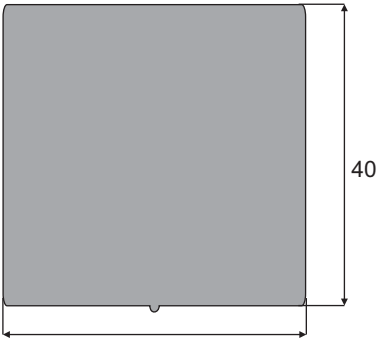
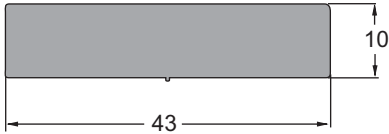

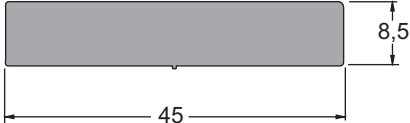
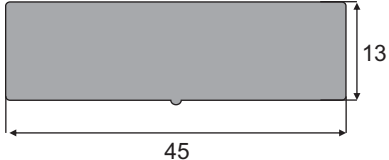
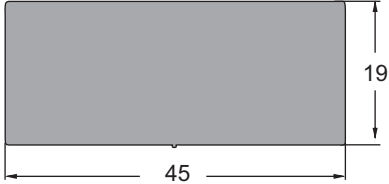
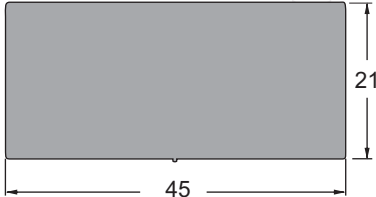
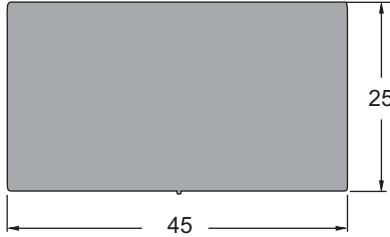
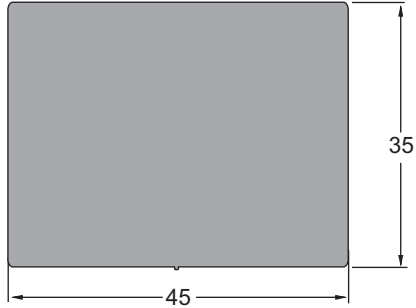
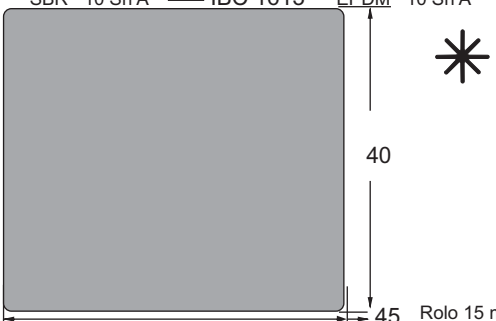
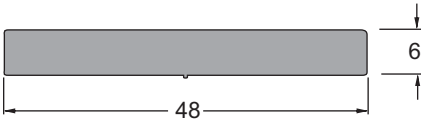
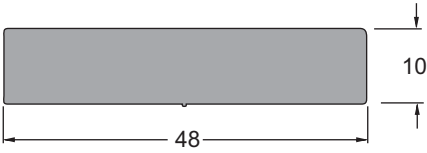
<p>IBC 1135 SBR 15 Sh A</p>  <p>Rolo 50 m</p>	<p>IBC 1353 SBR 10 Sh A</p>  <p>Rolo 50 m</p>	<p>IBC 1050 SBR 10 Sh A</p>  <p>Rolo 25 m</p>	<p>IBC 1354 SBR 10 Sh A</p>  <p>Rolo 25 m</p>
<p>IBC 1319 SBR 10 Sh A</p>  <p>Rolo 25 m</p>	<p>IBC 1458 SBR 10 Sh A</p>  <p>Rolo 25 m</p>	<p>IBC 1492 SBR 10 Sh A</p>  <p>Rolo 25 m</p>	<p>IBC 1482 SBR 10 Sh A</p>  <p>Rolo 25 m</p>
<p>IBC 1501 EPDM 10 Sh A</p>  <p>Rolo 25 m</p>	<p>IBC 1236 SBR 10 Sh A</p>  <p>Rolo 25 m</p>	<p>IBC 1476 EPDM 10 Sh A</p>  <p>Rolo 25 m</p>	<p>IBC 1054 SBR 10 Sh A</p>  <p>Rolo 50 m</p>



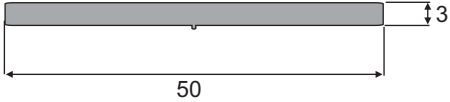
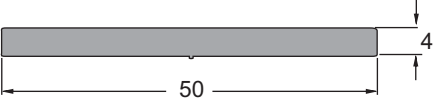
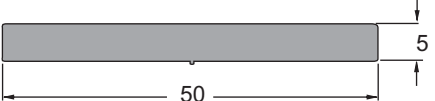
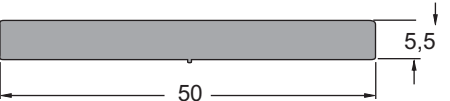

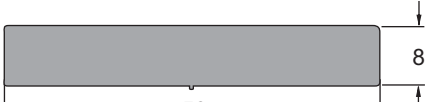

<p>IBC 1284 SBR 15 Sh A</p>  <p>38</p> <p>Rolo 50 m</p>	<p>IBC 1018 SBR 10 Sh A</p>  <p>38</p> <p>Rolo 50 m</p>	<p>IBC 1055 SBR 10 Sh A</p>  <p>38</p> <p>Rolo 25 m</p>	<p>IBC 1454 SBR 10 Sh A</p>  <p>38</p> <p>Rolo 25 m</p>
<p>IBC 1056 SBR 10 Sh A IBC 1231 EPDM 10 Sh A</p>  <p>38</p> <p>Rolo 25 m</p>	<p>IBC 1345 EPDM 10 Sh A IBC 1459 SBR 10 Sh A</p>  <p>38</p> <p>Rolo 25 m</p>	<p>IBC 1062 SBR 10 Sh A</p>  <p>38</p> <p>Rolo 25 m</p>	<p>IBC 1343 EPDM 10 Sh A IBC 1488 SBR 10 Sh A</p>  <p>38</p> <p>Rolo 25 m</p>
<p>IBC 1296 EPDM 10 Sh A</p>  <p>38</p> <p>Rolo 25 m</p>	<p>IBC 1138 SBR 10 Sh A</p>  <p>38</p> <p>Rolo 25 m</p>	<p>IBC 1387 SBR 10 Sh A</p>  <p>40</p> <p>Rolo 50 m</p>	<p>IBC 1393 SBR 10 Sh A</p>  <p>40</p> <p>Rolo 50 m</p>
<p>IBC 1363 SBR 10 Sh A</p>  <p>40</p> <p>Rolo 50 m</p>	<p>IBC 1400 SBR 10 Sh A</p>  <p>40</p> <p>Rolo 25 m</p>	<p>IBC 1140 SBR 10 Sh A</p>  <p>40</p> <p>Rolo 25 m</p>	<p>IBC 1013 SBR 10 Sh A IBC 1508 EPDM 10 Sh A IBC 1528 SBR 20 Sh A</p>  <p>40</p> <p>Rolo 25 m</p>

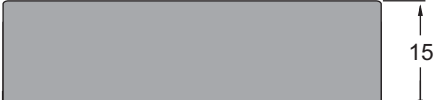



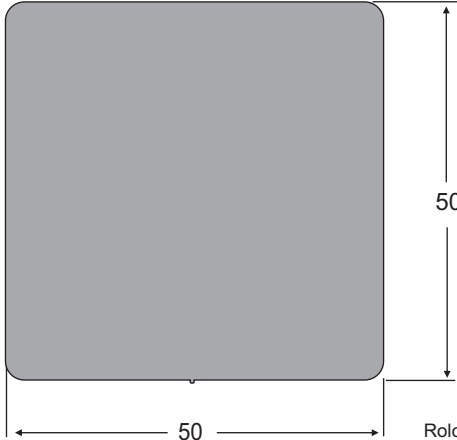

<p>IBC 1046 SBR 10 Sh A IBC 1230 EPDM 10 Sh A</p>  <p style="text-align: right;">Rolo 25 m</p>	<p>IBC 1406 SBR 10 Sh A</p>  <p style="text-align: right;">Rolo 25 m</p>	<p>IBC 1045 SBR 10 Sh A</p>  <p style="text-align: right;">Rolo 25 m</p>
<p>IBC 1005 SBR 10 Sh A IBC 1502 EPDM 10 Sh A</p>  <p style="text-align: right;">Rolo 25 m</p>	<p>IBC 1156 SBR 10 Sh A IBC 1426 SBR 25 Sh A</p>  <p style="text-align: right;">Rolo 25 m</p>	<p>IBC 1346 SBR 10 Sh A IBC 1379 EPDM 10 Sh A</p>  <p style="text-align: right;">Rolo 25 m</p>
<p>IBC 1349 SBR 10 Sh A</p>  <p style="text-align: right;">Rolo 25 m</p>	<p>IBC 1464 EPDM 10 Sh A IBC 1471 SBR 10 Sh A</p>  <p style="text-align: right;">Rolo 25 m</p>	<p>IBC 1494 SBR 10 Sh A</p>  <p style="text-align: right;">Rolo 25 m</p>

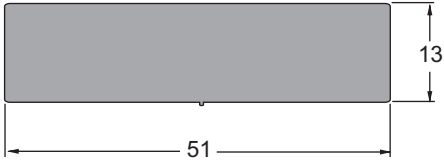

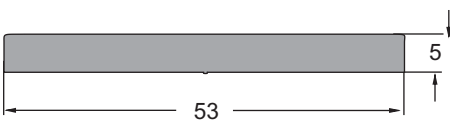
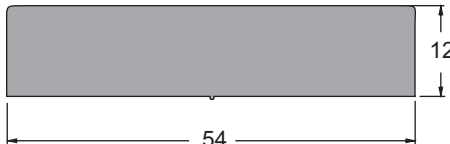
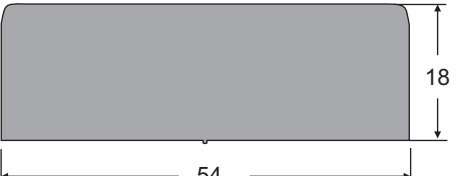
<p>IBC 1057 SBR 10 Sh A IBC 1342 SBR 15 Sh A</p>  <p>Rolo 25 m</p>	<p>IBC 1455 SBR 10 Sh A</p>  <p>Rolo 25 m</p>	<p>IBC 1237 SBR 10 Sh A</p>  <p>Rolo 25 m</p>
<p>IBC 1154 SBR 10 Sh A</p>  <p>Rolo 25 m</p>	<p>IBC 1216 SBR 10 Sh A IBC 1523 SBR 15 Sh A</p>  <p>Rolo 25 m</p>	<p>IBC 1220 SBR 10 Sh A</p>  <p>Rolo 25 m</p>
<p>IBC 1603 SBR 10 Sh A — IBC 1613 EPDM 10 Sh A</p>  <p>Rolo 15 m</p>	<p>IBC 1248 SBR 15 Sh A</p>  <p>Rolo 25 m</p>	<p>IBC 1280 SBR 10 Sh A</p>  <p>Rolo 25 m</p>

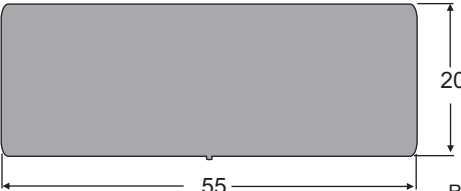
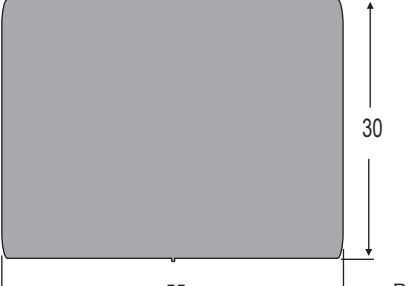
* ITEM NOVO

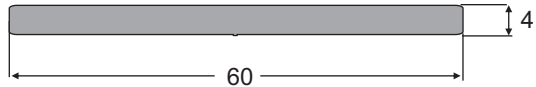
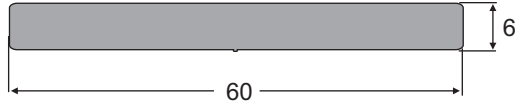
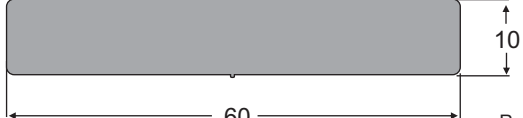

<p>IBC 1289 SBR 15 Sh A</p>  <p>Rolo 25 m</p>	<p>IBC 1394 SBR 10 Sh A</p>  <p>Rolo 25 m</p>	<p>IBC 1397 SBR 10 Sh A</p>  <p>Rolo 25 m</p>
<p>IBC 1097 SBR 10 Sh A</p>  <p>Rolo 25 m</p>	<p>IBC 1401 SBR 10 Sh A</p>  <p>Rolo 25 m</p>	<p>IBC 1157 SBR 10 Sh A</p>  <p>Rolo 25 m</p>
<p>IBC 1403 SBR 10 Sh A IBC 1509 EPDM 10 Sh A</p>  <p>Rolo 25 m</p>	<p>IBC 1276 SBR 10 Sh A</p>  <p>Rolo 25 m</p>	<p>IBC 1158 SBR 10 Sh A IBC 1232 EPDM 10 Sh A IBC 1461 SBR 25 Sh A</p>  <p>Rolo 25 m</p>
<p>IBC 1407 SBR 10 Sh A</p>  <p>Rolo 25 m</p>		

<p>IBC 1348 SBR 10 Sh A</p>  <p>50</p> <p>20</p> <p>Rolo 25 m</p>	<p>IBC 1241 SBR 10 Sh A</p>  <p>50</p> <p>25</p> <p>Rolo 25 m</p>	<p>IBC 1408 SBR 10 Sh A</p>  <p>50</p> <p>30</p> <p>Rolo 25 m</p>
<p>IBC 1293 SBR 10 Sh A</p>  <p>50</p> <p>32</p> <p>Rolo 15 m</p>	<p>IBC 1553 SBR 10Sh A</p>  <p>50</p> <p>40</p> <p>Rolo 15 m</p>	<p>IBC 1271 SBR 10 Sh A</p>  <p>50</p> <p>50</p> <p>Rolo 10 m</p>
<p>IBC 1322 SBR 10 Sh A</p>  <p>50,5</p> <p>4</p> <p>Rolo 25 m</p>	<p>IBC 1290 SBR 10 Sh A</p>  <p>51</p> <p>6</p> <p>Rolo 25 m</p>	<p>IBC 1281 SBR 10 Sh A</p>  <p>51</p> <p>13</p> <p>Rolo 25 m</p>

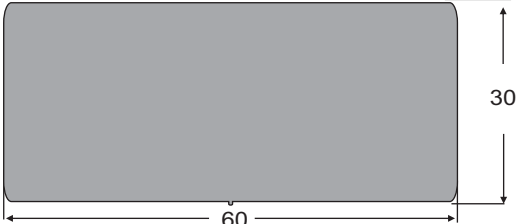
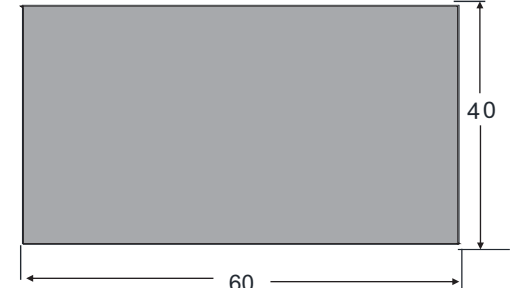
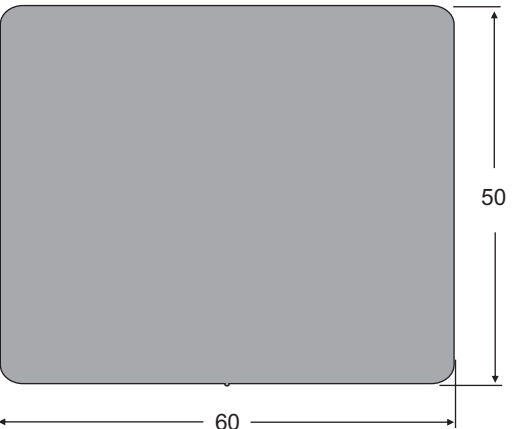
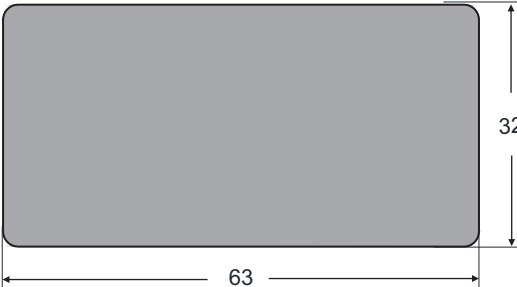
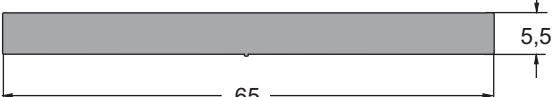
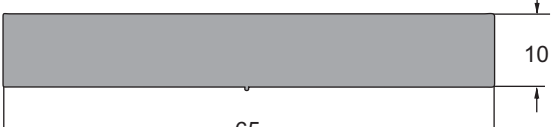

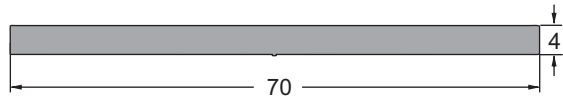
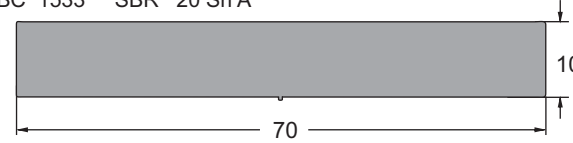
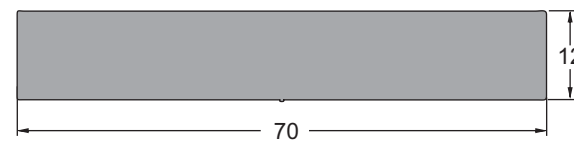
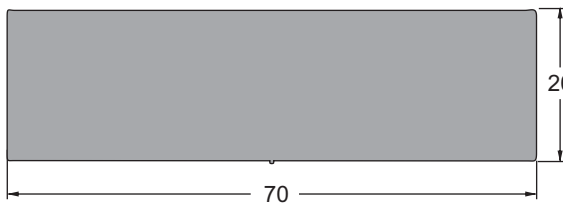

<p>IBC 1460 SBR 15 Sh A</p>  <p>52</p> <p>15</p> <p>Rolo 25 m</p>	<p>IBC 1495 SBR 10 Sh A</p>  <p>53</p> <p>5</p> <p>Rolo 50 m</p>	<p>IBC 1026 SBR 10 Sh A</p>  <p>54</p> <p>12</p> <p>Rolo 25 m</p>
<p>IBC 1047 SBR 10 Sh A IBC 1527 EPDM 10 Sh A</p>  <p>54</p> <p>18</p> <p>Rolo 25 m</p>	<p>IBC 1341 EPDM 20 Sh A</p>  <p>54</p> <p>25</p> <p>Rolo 25 m</p>	<p>IBC 1496 SBR 10 Sh A IBC 1534 SBR 20 Sh A</p>  <p>55</p> <p>10</p> <p>Rolo 25 m</p>
<p>IBC 1377 SBR 10 Sh A</p>  <p>55</p> <p>20</p> <p>Rolo 25 m</p>	<p>IBC 1358 SBR 10 Sh A</p>  <p>55</p> <p>30</p> <p>Rolo 15 m</p>	<p>IBC 1519 SBR 15 Sh A</p>  <p>58</p> <p>6</p> <p>Rolo 25 m</p>
<p>IBC 1520 SBR 10 Sh A</p>  <p>58</p> <p>9,5</p> <p>Rolo 25 m</p>	<p>IBC 1521 SBR 10 Sh A</p>  <p>58</p> <p>11</p> <p>Rolo 25 m</p>	<p>IBC 1522 SBR 10 Sh A</p>  <p>58</p> <p>13</p> <p>Rolo 25 m</p>

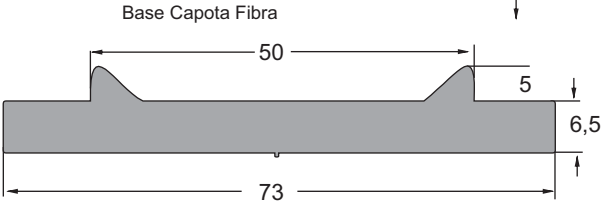
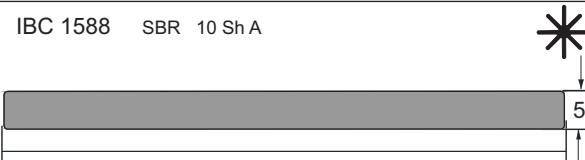
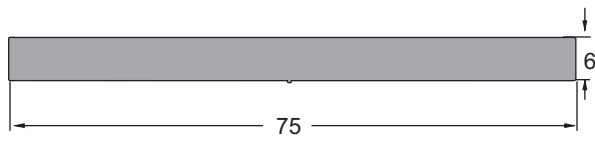
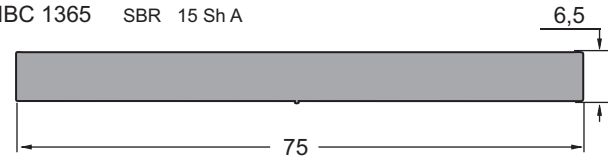
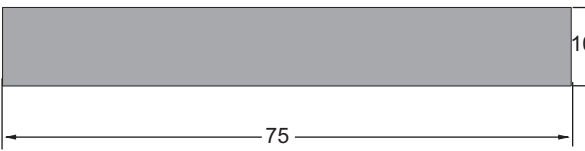
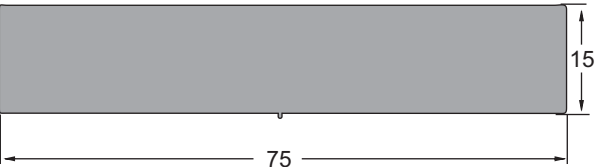
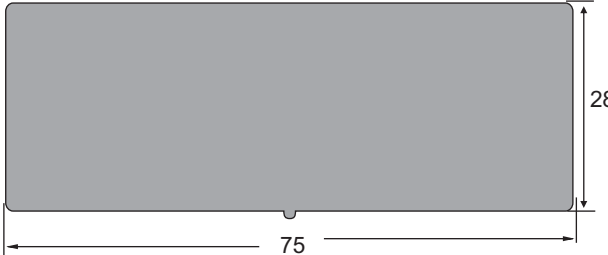

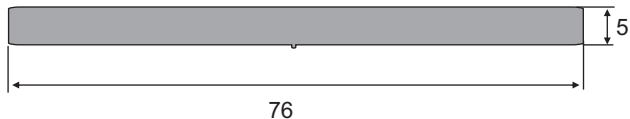
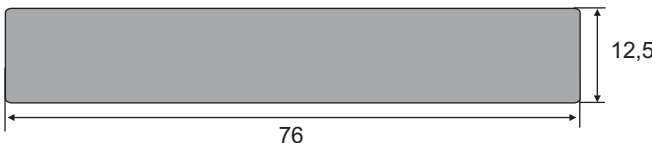
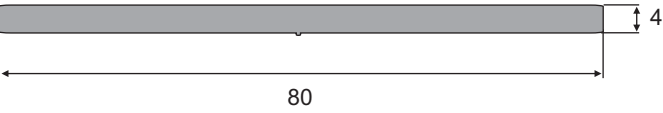
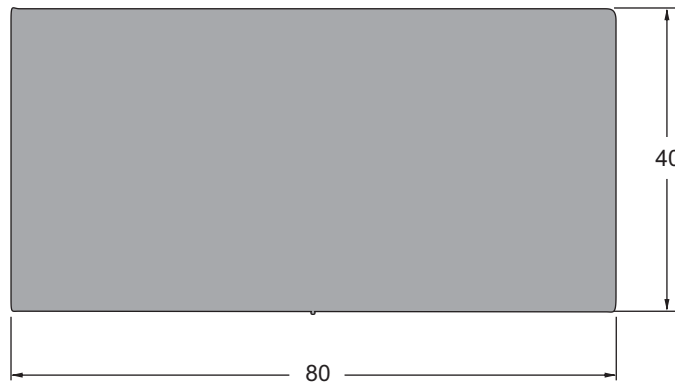

<p>IBC 1411 SBR 10 Sh A</p>  <p>Rolo 25 m</p>	<p>IBC 1436 SBR 10 Sh A</p>  <p>Rolo 25 m</p>	<p>IBC 1273 SBR 10 Sh A IBC 1529 SBR 20 Sh A</p>  <p>Rolo 25 m</p>	
<p>IBC 1272 SBR 10 Sh A</p>  <p>Rolo 25 m</p>	<p>IBC 1409 SBR 10 Sh A</p>  <p>Rolo 25 m</p>	<p>IBC 1554 SBR 10 Sh A</p>  <p>Rolo 15 m</p>	
<p>IBC 1268 SBR 10 Sh A</p>  <p>Rolo 10 m</p>	<p>IBC 1586 SBR 10 Sh A</p>  <p>Rolo 15 m</p>	<p>IBC 1228 SBR 10 Sh A</p>  <p>Rolo 25 m</p>	
			<p>IBC 1497 SBR 10 Sh A</p>  <p>Rolo 25 m</p>

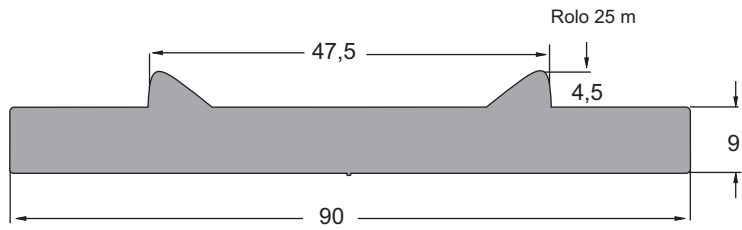
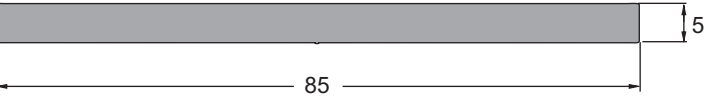
* ITEM NOVO



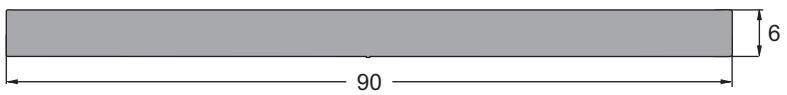
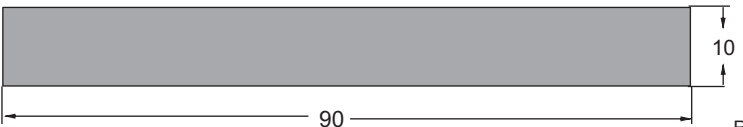
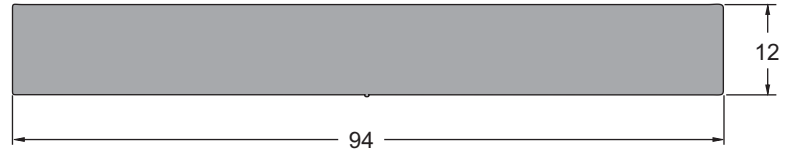
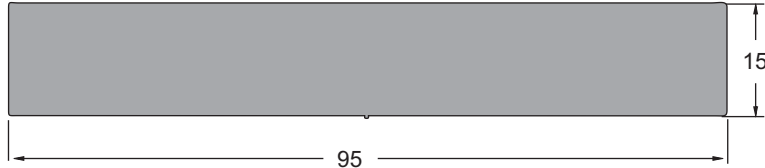

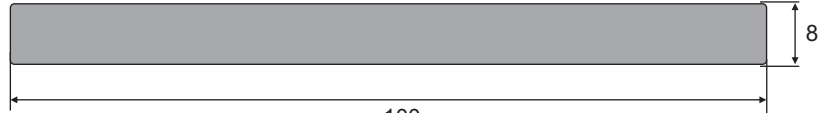
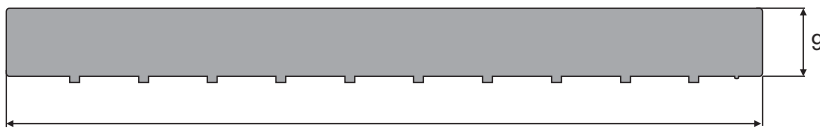
<p>IBC 1412 SBR 15 Sh A</p>  <p>Rolo 25 m</p>	<p>IBC 1199 SBR 10 Sh A IBC 1275 SBR 15 Sh A IBC 1533 SBR 20 Sh A</p>  <p>Rolo 25 m</p>	<p>IBC 1417 SBR 10 Sh A</p>  <p>Rolo 25 m</p>
<p>IBC 1309 SBR 10 Sh A</p>  <p>Rolo 25 m</p>	<p>IBC 1602 EPDM 10 Sh A</p>  <p>Rolo 15 m</p>	<p>IBC 1068 SBR 10 Sh A Base Capota Fibra</p>  <p>Rolo 25 m</p>
<p>IBC 1588 SBR 10 Sh A</p>  <p>Rolo 25 m</p>	<p>IBC 1414 SBR 10 Sh A</p>  <p>Rolo 25 m</p>	<p>IBC 1029 SBR 10 Sh A IBC 1365 SBR 15 Sh A</p>  <p>Rolo 25 m</p>
<p>IBC 1530 SBR 20 Sh A</p>  <p>Rolo 25 m</p>	<p>IBC 1418 SBR 10 Sh A</p>  <p>Rolo 25 m</p>	<p>IBC 1468 SBR 10 Sh A</p>  <p>Rolo 15 m</p>

* ITEM NOVO

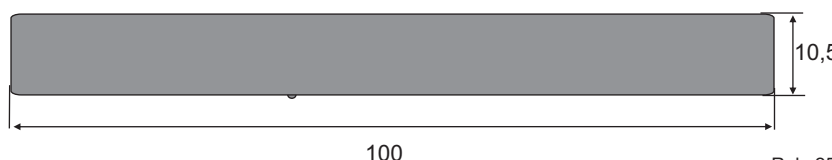
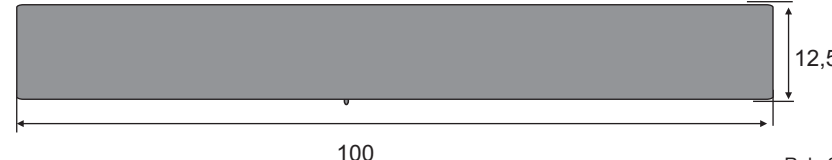

<p>IBC 1291 SBR 15 Sh A</p>  <p>Rolo 25 m</p>	<p>IBC1474 SBR 10 Sh A</p>  <p>Rolo 25 m</p>
<p>IBC 1413 SBR 15 Sh A</p>  <p>Rolo 25 m</p>	<p>IBC 1151 SBR 10 Sh A</p>  <p>Rolo 10 m</p>
<p>IBC 1498 SBR 10 Sh A IBC 1531 SBR 20 Sh A</p>  <p>Rolo 25 m</p>	<p>IBC 1212 SBR 10 Sh A</p>  <p>Rolo 25 m</p>
<p>IBC 1499 SBR 15 Sh A</p>  <p>Rolo 25 m</p>	
<p>IBC 1481 EPDM 25 Sh A</p>  <p>Rolo 25 m</p>	

<p>IBC 1500 SBR 15 Sh A</p>  <p>Rolo 25 m</p>	<p>IBC 1532 SBR 20 Sh A</p>  <p>Rolo 25 m</p>
<p>IBC 1213 SBR 15 Sh A</p>  <p>Rolo 15 m</p>	<p>IBC 1214 SBR 15 Sh A</p>  <p>Rolo 15 m</p>
<p>IBC 1294 EPDM 20 Sh A IBC 1473 SBR 15 Sh A</p>  <p>Rolo 25 m</p>	<p>IBC 1601 EPDM 20 Sh A</p>  <p>Rolo 25 m</p> <p style="text-align: right;">*</p>
<p>IBC 1298 SBR 25 Sh A</p>  <p>Rolo 25 m</p>	<p>IBC 1439 SBR 10 Sh A IBC 1557 SBR 20 Sh A</p>  <p>Rolo 25 m</p> <p style="text-align: right;">*</p>

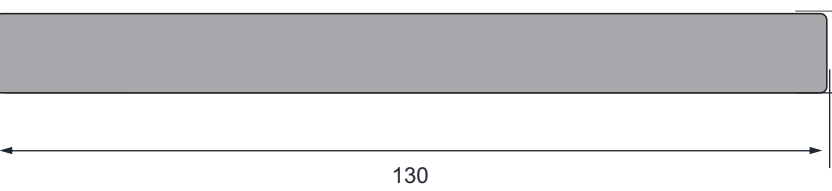
* ITEM NOVO

<p>IBC 1556 SBR 15 Sh A</p>  <p>100</p> <p>Rolo 25 m</p>	<p>IBC 1516 SBR 10 Sh A</p>  <p>100</p> <p>Rolo 25 m</p>
<p>IBC 1430 SBR 15 Sh A</p>  <p>100</p> <p>Rolo 10 m</p>	<p>IBC 1587 SBR 15 Sh A</p>  <p>100</p> <p>Rolo 10 m</p>
<p>IBC 1575 SBR 10 Sh A</p>  <p>127</p> <p>Rolo 10 m</p>	<p>IBC 1581 SBR 15 Sh A</p>  <p>130</p> <p>Rolo 15 m</p>

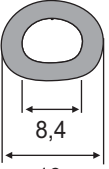
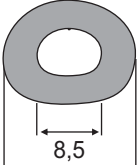
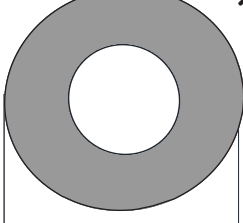
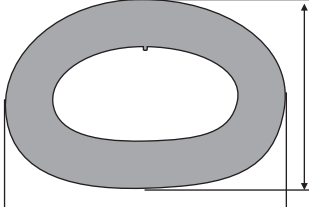
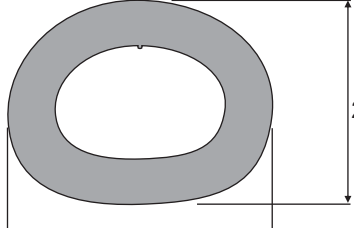
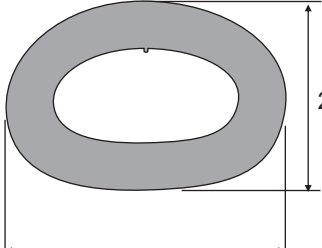
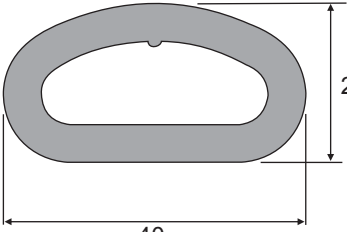
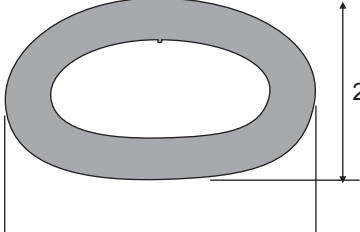
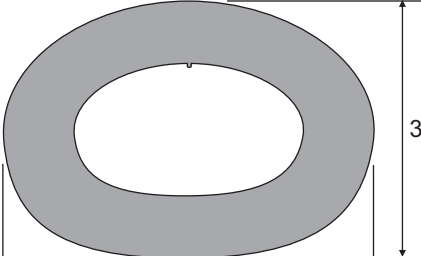
* ITEM NOVO

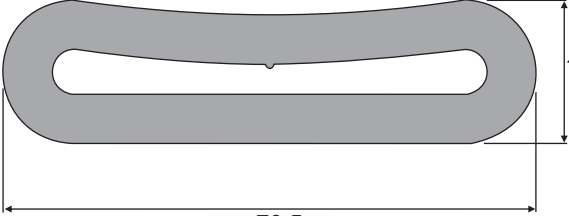
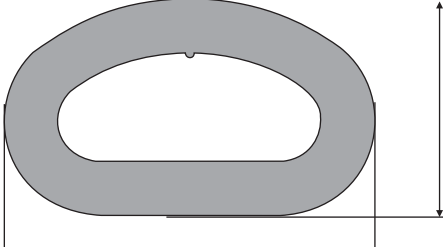
<p>IBC 1421 SBR 25 Sh A</p>  <p>8,4 13</p> <p>Rolo 50 m</p>	<p>IBC 1422 SBR 25 Sh A</p>  <p>8,5 17,5</p> <p>Rolo 25 m</p>	<p>IBC 1571 EPDM 25 Sh A *</p>  <p>33</p> <p>∅ Interno: 15 mm</p> <p>Rolo 25 m</p>	<p>IBC 1589 EPDM 25 Sh A *</p>  <p>42 34</p> <p>∅ Interno: 20 mm usar em 23mm</p> <p>Rolo 25 m</p>	<p>IBC 1329 EPDM 25 Sh A</p>  <p>27 37</p> <p>∅ Interno: 21 mm usar em 25,4mm</p> <p>Rolo 25 m</p>
<p>IBC 1315 SBR 25 Sh A</p>  <p>25 37</p> <p>∅ Interno: 18,5 mm usar em até 23mm</p> <p>Rolo 25 m</p>	<p>IBC 1447 SBR 25 Sh A</p>  <p>21 40</p> <p>∅ Interno: 21 mm usar em 25,4mm</p> <p>Rolo 25 m</p>	<p>IBC 1316 SBR 25 Sh A IBC 1330 EPDM 25 Sh A IBC 1462 EPDM 20 Sh A</p>  <p>24 41</p> <p>∅ Interno: 22 mm usar em até 27mm</p> <p>Rolo 25 m</p>	<p>IBC 1266 SBR 25 Sh A IBC 1331 EPDM 25 Sh A</p>  <p>32 45</p> <p>∅ Interno: 22 mm usar em até 27mm</p> <p>Rolo 25 m</p>	
<p>IBC 1448 SBR 50 Sh A</p>  <p>20 74</p> <p>∅ Interno: 25,4mm</p> <p>Rolo 25 m</p>	<p>IBC 1449 SBR 50 Sh A</p>  <p>19 70,5</p> <p>∅ Interno: 42 mm</p> <p>Rolo 25 m</p>	<p>IBC 1472 EPDM 25 Sh A</p>  <p>32,5 47</p> <p>∅ Interno: 25,6 mm usar em 30mm</p> <p>Rolo 25 m</p>		

* MEDIDAS ALTERADAS



CONSIDERAÇÕES IMPORTANTES

ACONDICIONAMENTO DOS CORDÕES ESPONJOSOS

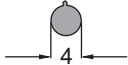

Φ mm	m/rolo	Frações/rolo
4 a 7	150	3 x 50 m
8 a 10	75	3 x 25 m
11 a 14	60	3 x 20 m
15 a 25	25	Inteiro

TABELA DE TOLERÂNCIAS

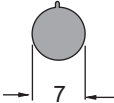
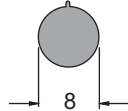
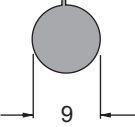
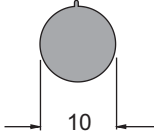
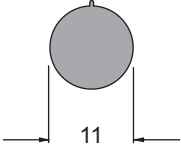
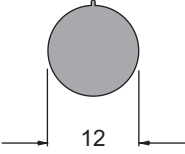
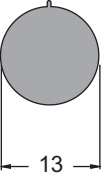
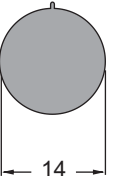
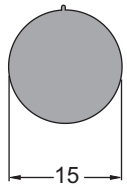
COTA mm	COTA (mm)	até 5	6 a 10	11 a 15	16 a 20	21 a 30	31 a 50	51 a 80	81 a 120	121 a 180
MACIÇA	MACIÇA	± 0,2	± 0,3	± 0,4	± 0,5	± 0,7	± 1,0	± 1,2	± 1,4	± 1,6
ESPONJA	ESPONJA	± 0,3	± 0,4	± 0,5	± 0,8	± 1,0	± 1,5	± 2,0	± 2,5	± 3,0

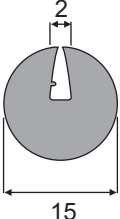
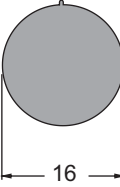
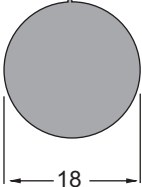
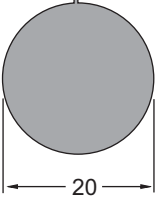
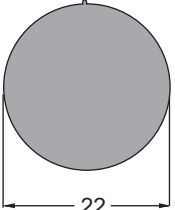
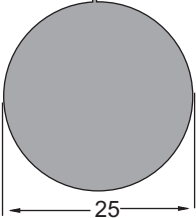
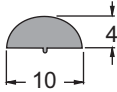
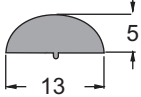
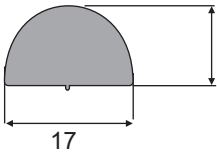
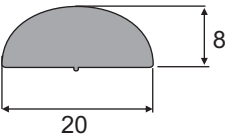
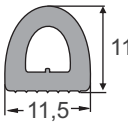
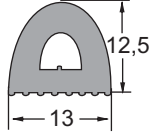
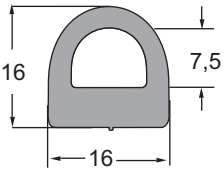

IBC 1204 SBR 15 Sh A IBC 1548 EPDM 15 Sh A  Rolo 150 m	IBC 1147 SBR 10 Sh A IBC 1549 EPDM 15 Sh A  Rolo 150 m	IBC 1015 SBR 10 Sh A IBC 1550 EPDM 15 Sh A  Rolo 150 m	IBC 1020 SBR 10 Sh A IBC 1551 EPDM 15 Sh A  Rolo 150 m
IBC 1038 SBR 10 Sh A IBC 1552 EPDM 15 Sh A  Rolo 75 m	IBC 1041 SBR 10 Sh A  Rolo 75 m	IBC 1027 SBR 10 Sh A  Rolo 75 m	IBC 1069 SBR 10 Sh A IBC 1239 SBR 15 Sh A  Rolo 60 m
IBC 1070 SBR 10 Sh A IBC 1489 EPDM 10 Sh A  Rolo 60 m	IBC 1071 SBR 10 Sh A  Rolo 60 m	IBC 1227 SBR 10 Sh A  Rolo 60 m	IBC 1310 SBR 10 Sh A  Rolo 25 m

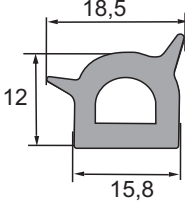
✱ ITENS NOVOS

IBC 1099 SBR 15 Sh A  Rolo 50 m	IBC 1153 SBR 10 Sh A  Rolo 25 m	IBC 1244 SBR 10 Sh A  Rolo 25 m	IBC 1245 SBR 10 Sh A  Rolo 25 m
IBC 1311 SBR 10 Sh A  Rolo 25 m	IBC 1312 SBR 10 Sh A  Rolo 25 m	IBC 1040 SBR 10 Sh A  Rolo 100 m	IBC 1478 SBR 25 Sh A  Rolo 75 m
IBC 1321 SBR 10 Sh A  Rolo 100 m	IBC 1368 EPDM 20 Sh A  Rolo 50 m	IBC 1175 SBR 25 Sh A IBC 1456 EPDM 25 Sh Vedação Tampa de Tambor  Rolo 100 m	IBC 1197 SBR 25 Sh A IBC 1457 EPDM 25 Sh A Vedação Tampa de Tambor  Rolo 100 m
IBC 1206 EPDM 15 Sh A Base Capô África Marcopolo  Rolo 50 m	IBC 1525 EPDM 20 Sh A  Rolo 30 m	IBC 1590 EPDM 10 Sh A  Rolo 100 m	IBC 1592 EPDM 15 Sh A  Rolo 25 m

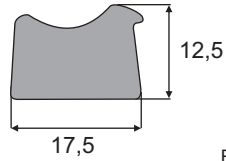
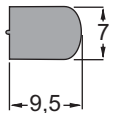
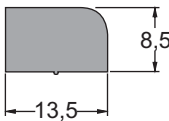
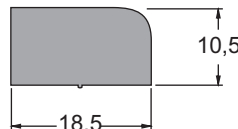
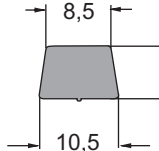
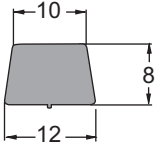
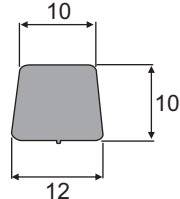
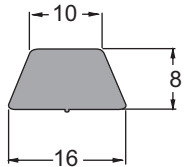
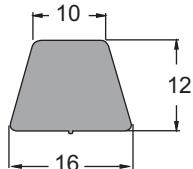
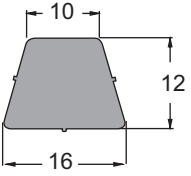
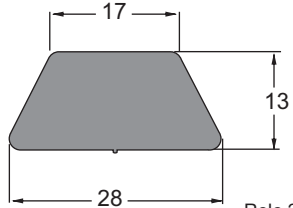
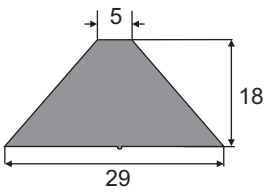
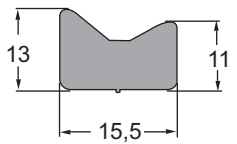
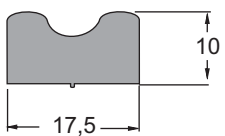
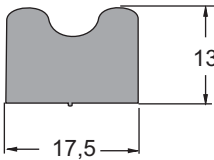
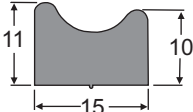
* ITEM NOVO

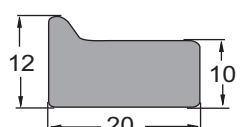
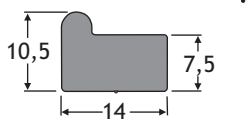
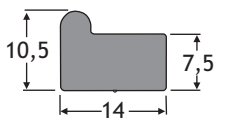
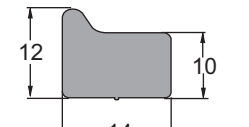
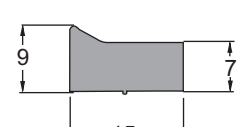
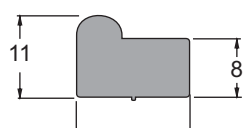
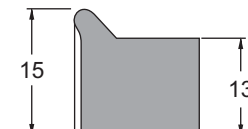
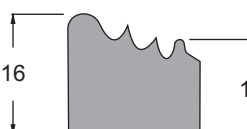
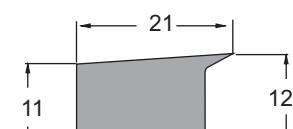
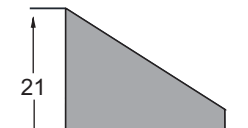
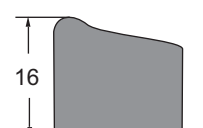
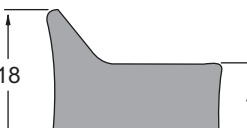
<p>IBC 1186 SBR 10 Sh A IBC 1453 EPDM 10 Sh A Vedação Quadro Comando</p>  <p>12,5 17,5</p> <p>Rolo 50 m</p>	<p>IBC 1176 SBR 10 Sh A</p>  <p>7 9,5</p> <p>Rolo 100 m</p>	<p>IBC 1012 SBR 10 Sh A</p>  <p>8,5 13,5</p> <p>Rolo 50 m</p>	<p>IBC 1136 SBR 10 Sh A</p>  <p>10,5 18,5</p> <p>Rolo 50 m</p>
<p>IBC 1222 SBR 10 Sh A IBC 1470 EPDM 15 Sh A Vedação Quadro de Comando</p>  <p>8,5 7 10,5</p> <p>Rolo 100 m</p>	<p>IBC 1215 SBR 10 Sh A IBC 1210 EPDM 15 Sh A IBC 1263 EPDM 20 Sh A Vedação Quadro de Comando</p>  <p>10 8 12</p> <p>Rolo 100 m</p>	<p>IBC 1308 EPDM 10 Sh A</p>  <p>10 10 12</p> <p>Rolo 50 m</p>	<p>IBC 1198 SBR 10 Sh A IBC 1466 EPDM 10 Sh A Vedação Quadro de Comando</p>  <p>10 8 16</p> <p>Rolo 50 m</p>
<p>IBC 1066 SBR 10 Sh A IBC 1149 EPDM 10 Sh A Vedação Quadro de Comando</p>  <p>10 12 16</p> <p>Rolo 50 m</p>	<p>IBC 1371 EPDM 15 Sh A Vedação Quadro de Comando</p>  <p>10 12 16</p> <p>Rolo 50 m</p>	<p>IBC 1254 SBR 10 Sh A</p>  <p>17 13 28</p> <p>Rolo 25 m</p>	<p>IBC 1334 SBR 10 Sh A</p>  <p>5 18 29</p> <p>Rolo 25 m</p>
<p>IBC 1205 SBR 10 Sh A Vedação Tampa Inspeção Painel Marcopolo</p>  <p>13 11 15,5</p> <p>Rolo 50 m</p>	<p>IBC 1035 SBR 10 Sh A Vedação Feixo Retrátil Esquadrias</p>  <p>10 17,5</p> <p>Rolo 50 m</p>	<p>IBC 1092 SBR 10 Sh A</p>  <p>13 17,5</p> <p>Rolo 50 m</p>	<p>IBC 1433 SBR 15 Sh A Vedação Universal</p>  <p>11 10 15</p> <p>Rolo 50 m</p>

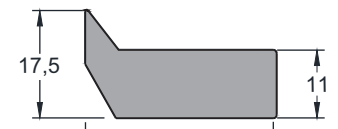
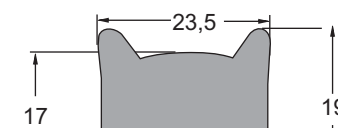
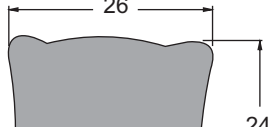
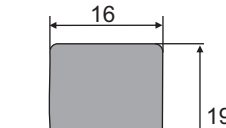
<p>IBC 1517 SBR 10 Sh A</p>  <p>Rolo 50 m</p>	<p>IBC 1607 EPDM 15 Sh A *</p>  <p>Rolo 100 m</p>	<p>IBC 1431 SBR 15 Sh A</p>  <p>Rolo 50 m</p>	<p>IBC 1065 SBR 10 Sh A</p>  <p>Rolo 50 m</p>	<p>IBC 1064 SBR 10 Sh A</p>  <p>Rolo 50 m</p>
<p>IBC 1109 SBR 10 Sh A Vedação Ônibus Gabriela - Comil</p>  <p>Rolo 50 m</p>	<p>IBC 1073 SBR 10 Sh A Porta MB 0362 e 0364</p>  <p>Rolo 50 m</p>	<p>IBC 1128 SBR 10 Sh A Bagageiro Diplomata Busscar</p>  <p>Rolo 25 m</p>	<p>IBC 1074 SBR 10 Sh A</p>  <p>Rolo 50 m</p>	
<p>IBC 1555 EPDM 25 Sh A *</p>  <p>Rolo 25 m</p>	<p>IBC 1526 SBR 10 Sh A</p>  <p>Rolo 25 m</p>	<p>IBC 1372 SBR 15 Sh A</p>  <p>Rolo 25 m</p>	<p>IBC 1375 SBR 15 Sh A</p>  <p>Rolo 25 m</p>	
<p>IBC 1562 SBR 15 Sh A *</p>  <p>Rolo 25 m</p>	<p>IBC 1094 SBR 10 Sh A</p>  <p>Rolo 25 m</p>	<p>IBC 1145 SBR 10 Sh A</p>  <p>Rolo 25 m</p>	<p>IBC 1490 SBR 10 Sh A</p>  <p>Rolo 25 m</p>	

* ITEM NOVO

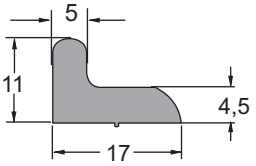
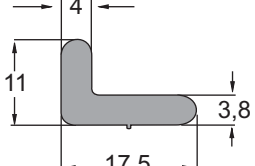
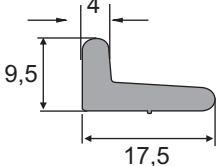
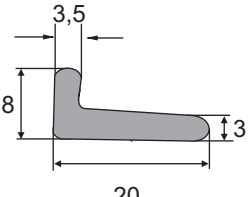
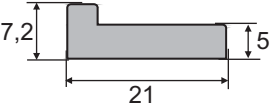
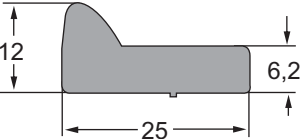
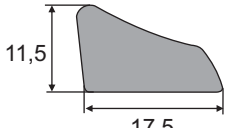
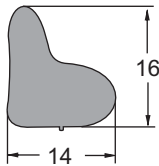
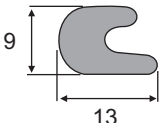
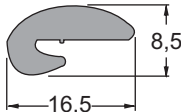
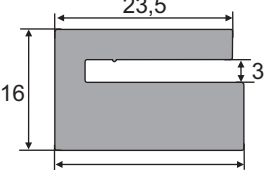
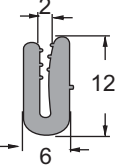
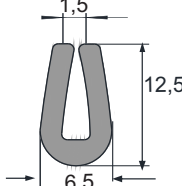
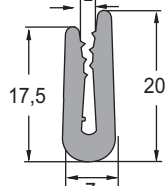
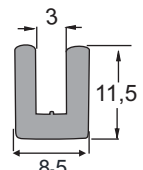
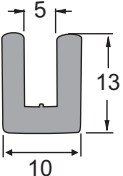
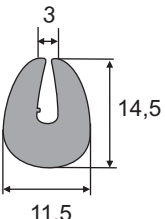
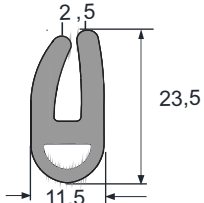
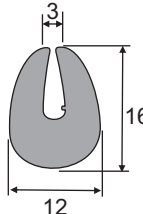
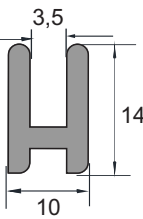
<p>IBC 1101 SBR 10 Sh A Vedação Base Capota</p>  <p>Rolo 50 m</p>	<p>IBC 1238 SBR 15 Sh A Vedação Base Capota</p>  <p>Rolo 100 m</p>	<p>IBC 1295 SBR 15 Sh A IBC 1344 EPDM 20 Sh A Vedação Base Capota</p>  <p>Rolo 50 m</p>	<p>IBC 1512 EPDM 15 Sh A Vedação Farol de Trator</p>  <p>Rolo 50 m</p>	<p>IBC 1606 EPDM 10 Sh A</p>  <p>Rolo 50 m</p>
<p>IBC 1278 SBR 10 Sh A Vedação Base Capotas</p>  <p>Rolo 25 m</p>	<p>IBC 1442 SBR 10 Sh A Vedação Base Capotas</p>  <p>Rolo 50 m</p>	<p>IBC 1179 SBR 10 Sh A</p>  <p>Rolo 50 m</p>	<p>IBC 1419 EPDM 20 Sh A</p>  <p>Rolo 100 m</p>	<p>IBC 1152 SBR 15 Sh A</p>  <p>Rolo 50 m</p>
<p>IBC 1178 EPDM 25 Sh A 23,5</p>  <p>Rolo 25 m</p>	<p>IBC 1172 EPDM 15 Sh A Comil</p>  <p>Rolo 100 m</p>	<p>IBC 1564 EPDM 20 Sh A</p>  <p>Rolo 100 m</p>	<p>IBC 1247 EPDM 15 Sh A</p>  <p>Rolo 100 m</p>	<p>IBC 1538 EPDM 20 Sh A</p>  <p>Rolo 50 m</p>
<p>IBC 1125 SBR 15 Sh A IBC 1477 EPDM 20 Sh A</p>  <p>Rolo 50 m</p>	<p>IBC 1325 EPDM 20 Sh A</p>  <p>Rolo 50 m</p>	<p>IBC 1576 EPDM 20 Sh A</p>  <p>Rolo 25 m</p>	<p>IBC 1350 EPDM 15 Sh A</p>  <p>Rolo 50 m</p>	<p>IBC 1547 EPDM 20 Sh A</p>  <p>Rolo 50 m</p>

* ITEM NOVO

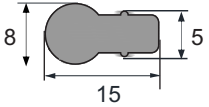
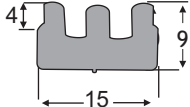
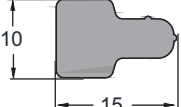
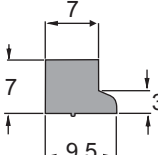
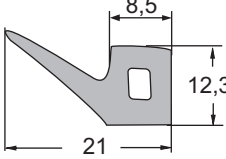
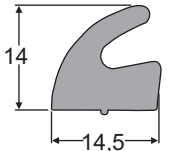
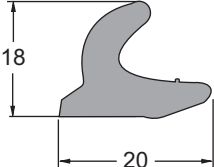
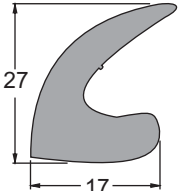
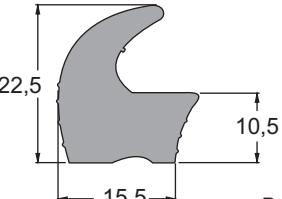
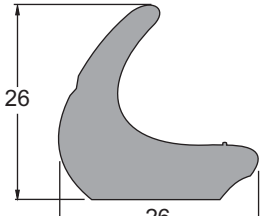
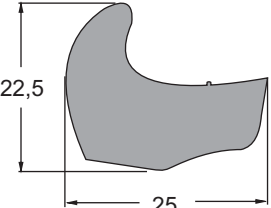
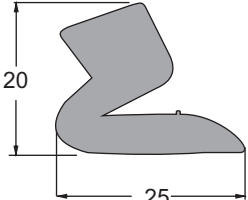
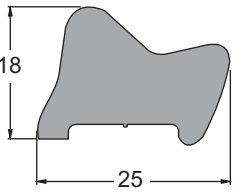
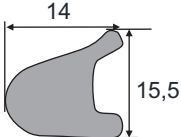
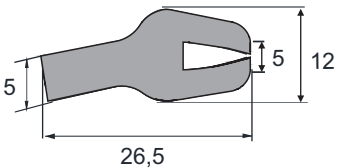
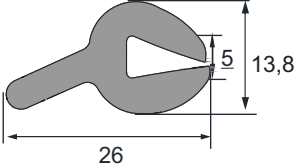
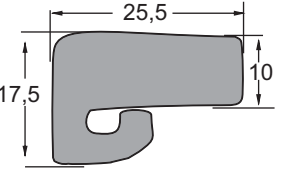
<p>IBC 1596 EPDM 10 Sh A</p>  <p>Rolo 100 m</p>	<p>IBC 1351 SBR 15 Sh A</p>  <p>Rolo 50 m</p>	<p>IBC 1357 EPDM 15 Sh A</p>  <p>Rolo 50 m</p>	<p>IBC 1196 SBR 25 Sh A Vedação Tampa de Tambor</p>  <p>Rolo 200 m</p>	<p>IBC 1504 EPDM 25 Sh A</p>  <p>Rolo 25 m</p>
<p>IBC 1434 SBR 15 Sh A Vedação Universal</p>  <p>Rolo 50 m</p>	<p>IBC 1166 SBR 10 Sh A</p>  <p>Rolo 50 m</p>	<p>IBC 1111 SBR 15 Sh A</p>  <p>Rolo 25 m</p>	<p>IBC 1103 SBR 15 Sh A</p>  <p>Rolo 25 m</p>	
<p>IBC 1102 SBR 15 Sh A Bagageiro MB 0364</p>  <p>Rolo 25 m</p>	<p>IBC 1142 SBR 15 Sh A</p>  <p>Rolo 25 m</p>	<p>IBC 1141 SBR 15 Sh A</p>  <p>Rolo 25 m</p>	<p>IBC 1143 SBR 15 Sh A</p>  <p>Rolo 25 m</p>	
<p>IBC 1503 EPDM 25 Sh A</p>  <p>Rolo 100 m</p>	<p>IBC 1541 EPDM 20 Sh A</p>  <p>Rolo 25 m</p>	<p>IBC 1572 EPDM 20 Sh A</p>  <p>Rolo 25 m</p>	<p>IBC 1535 EPDM 15 Sh A</p>  <p>Rolo 25 m</p>	

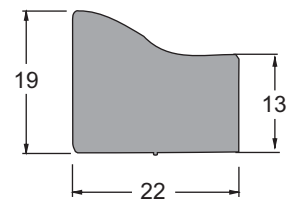
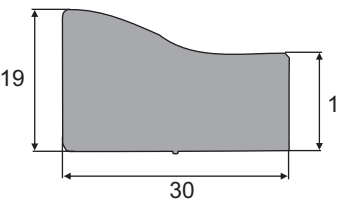
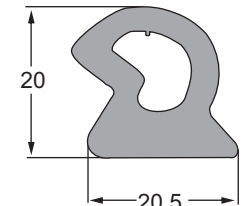
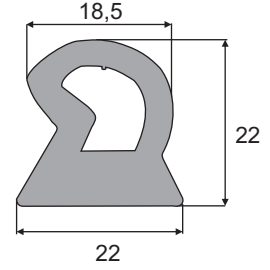
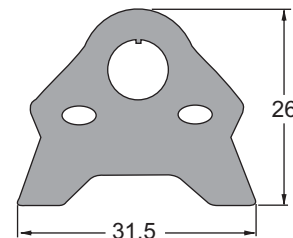
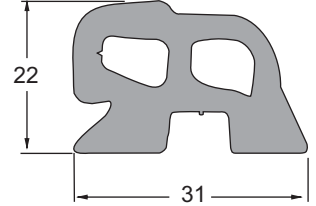
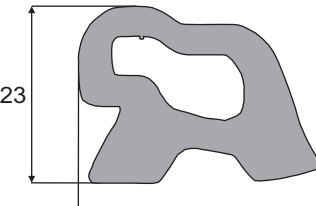
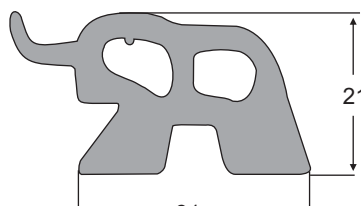
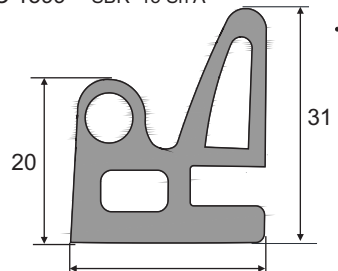
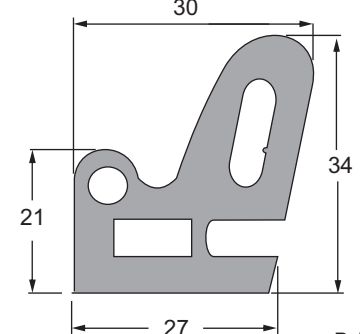
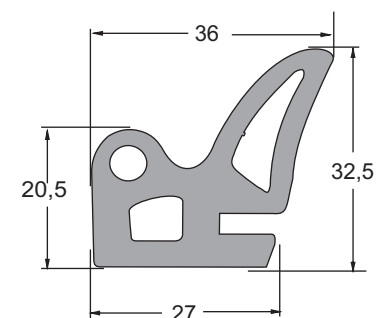
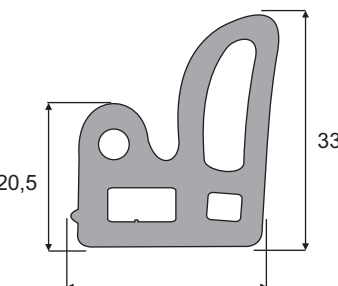
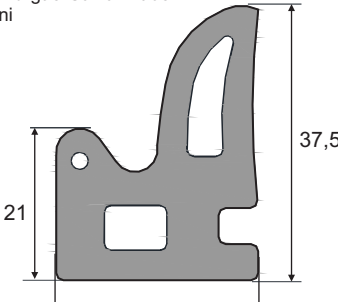
<p>IBC 1084 SBR 10 Sh A Vedação portas furgão</p>  <p>Rolo 25 m</p>	<p>IBC 1491 SBR 10 Sh A Vedação portas furgão</p>  <p>Rolo 25 m</p>	<p>IBC 1277 EPDM 10 Sh A Porta Lateral Linshalm</p>  <p>Rolo 25 m</p>	<p>IBC 1165 EPDM 10 Sh A Porta Lateral Linshalm</p>  <p>Rolo 25 m</p>	<p>IBC 1075 EPDM 15 Sh A</p>  <p>Rolo 25 m</p>
<p>IBC 1170 EPDM 15 Sh A Porta Traseira Linshalm</p>  <p>Rolo 25 m</p>	<p>IBC 1337 EPDM 10 Sh A Porta Tras Linshalm - Modelo 2005</p>  <p>Rolo 25 m</p>	<p>IBC 1085 EPDM 15 Sh A Porta Traseira Linshalm</p>  <p>Rolo 25 m</p>	<p>IBC 1599 SBR 15 Sh A</p>  <p>Rolo 25 m</p>	
<p>IBC 1155 SBR 15 Sh A Porta Furgão Fachini Alumínio</p>  <p>Rolo 25 m</p>	<p>IBC 1185 SBR 15 Sh A Porta Furgão Fachini Alumínio</p>  <p>Rolo 25 m</p>	<p>IBC 1303 EPDM 15 Sh A Porta Furgão Fachini Galvanizado</p>  <p>Rolo 25 m</p>	<p>IBC 1352 EPDM 15 Sh A Porta Furgão Galvanizado Fachini</p>  <p>Rolo 25 m</p>	

* ITEM NOVO

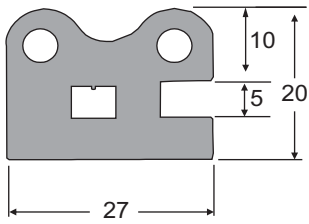
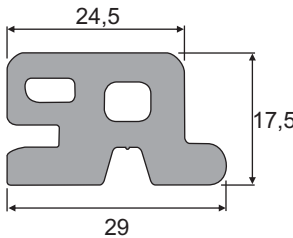
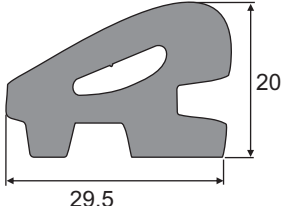
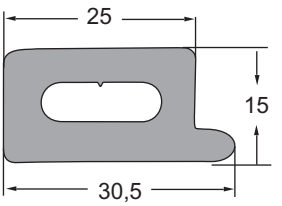
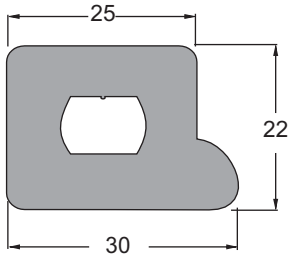
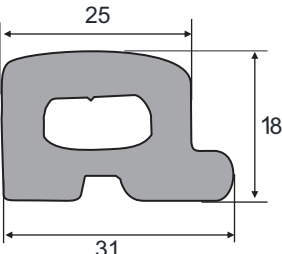
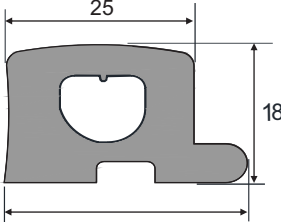
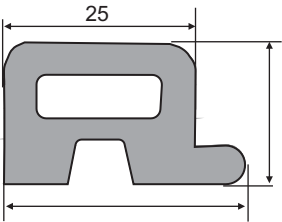
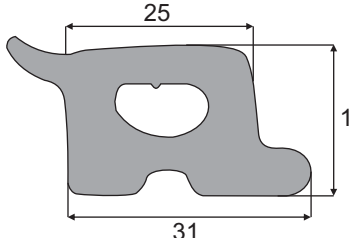
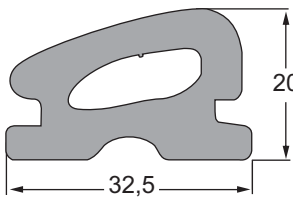
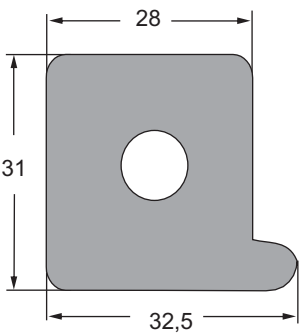
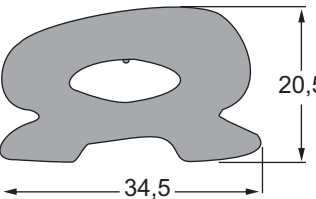
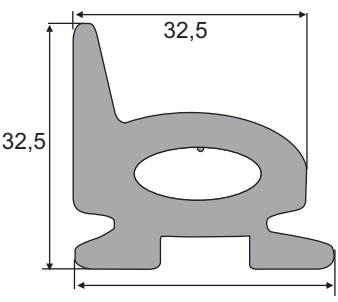
<p>IBC 1091 SBR 15 Sh A Caixa Rancho Fachini</p>  <p>Rolo 25 m</p>	<p>IBC 1360 SBR 15 Sh A Porta Furgão A Guerra</p>  <p>Rolo 25 m</p>	<p>IBC 1440 SBR 15 Sh A Porta furgão Antonini</p>  <p>Rolo 25 m</p>	<p>IBC 1524 EPDM 10 Sh A</p>  <p>Rolo 25 m</p>	<p>IBC 1098 SBR 10 Sh A Porta Furgão</p>  <p>Rolo 25 m</p>
<p>IBC 1233 SBR 15 Sh A</p>  <p>Rolo 25 m</p>	<p>IBC 1033 SBR 10 Sh A IBC 1518 EPDM 10 Sh A Porta Furgão Cargo Van</p>  <p>Rolo 25 m</p>	<p>IBC 1578 EPDM 10 Sh A Porta Furgão Cargo Van</p>  <p>Rolo 25 m</p>	<p>IBC 1373 SBR 10 Sh A Porta Furgão Cargo Van com aba</p>  <p>Rolo 25 m</p>	
<p>IBC 1264 SBR 15 Sh A Porta Furgão Rodoviária</p>  <p>Rolo 25 m</p>	<p>IBC 1511 SBR 10 Sh A</p>  <p>Rolo 25 m</p>	<p>IBC 1366 EPDM 15 Sh A Porta Furgão Randon</p>  <p>Rolo 25 m</p>	<p>IBC 1429 SBR 15 Sh A Porta furgão Randon c/ aba</p>  <p>Rolo 25 m</p>	

* ITEM NOVO

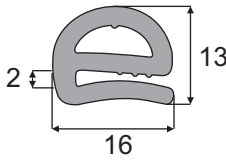
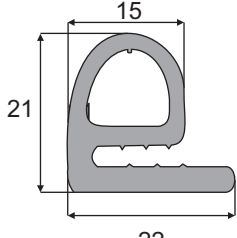
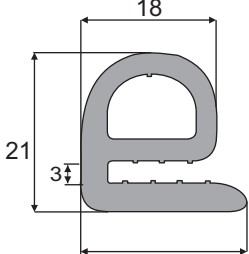
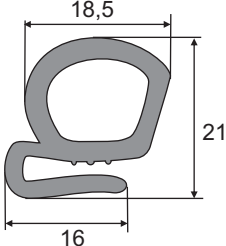
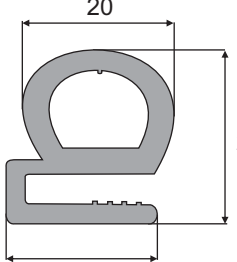
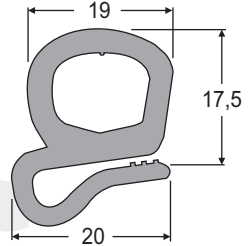
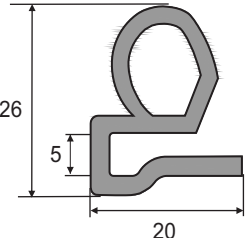
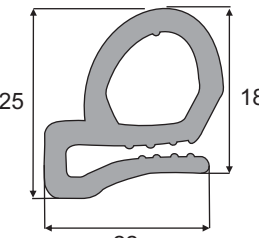
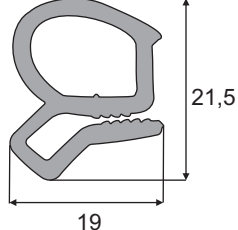
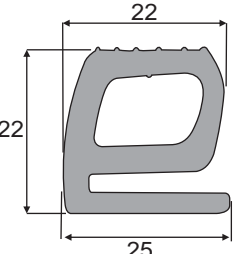
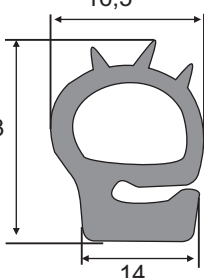
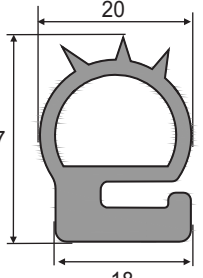
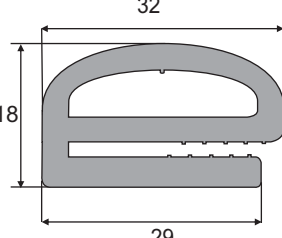
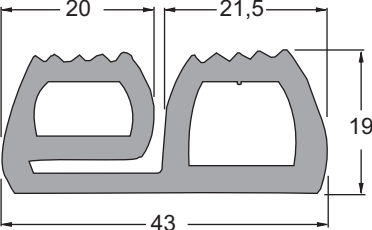
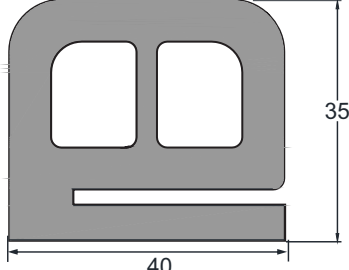
<p>IBC 1483 EPDM 20 Sh A</p>  <p>Rolo 25 m</p>	<p>IBC 1300 SBR 15 Sh A</p>  <p>Rolo 25 m</p>	<p>IBC 1150 SBR 15 Sh A</p>  <p>Rolo 25 m</p>	<p>IBC 1367 SBR 25 Sh A IBC 1452 EPDM 25 Sh A</p>  <p>Rolo 25 m</p>	<p>IBC 1224 SBR 15 Sh A</p>  <p>Rolo 25 m</p>
<p>IBC 1032 SBR 15 Sh A Portas C10/C14 até 84 F-1000 92</p>  <p>Rolo 25 m</p>	<p>IBC 1608 EPDM 15 Sh A *</p>  <p>Rolo 25 m</p>	<p>IBC 1320 EPDM 25 Sh A</p>  <p>Rolo 25 m</p>	<p>IBC 1359 EPDM 20 Sh A</p>  <p>Rolo 25 m</p>	<p>IBC 1173 SBR 15 Sh A IBC 1573 EPDM 15 Sh A</p>  <p>Rolo 25 m</p>
<p>IBC 1485 EPDM 20 Sh A</p>  <p>Rolo 25 m</p>	<p>IBC 1605 EPDM 20 Sh A *</p>  <p>Rolo 25 m</p>	<p>IBC 1326 EPDM 20 Sh A</p>  <p>Rolo 25 m</p>	<p>IBC 1039 SBR 15 Sh A IBC 1539 EPDM 15 Sh A Porta furgão</p>  <p>Rolo 25 m</p>	<p>IBC 1536 EPDM 25 Sh A</p>  <p>Rolo 25 m</p>

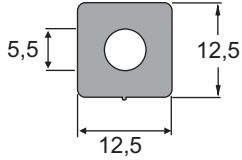
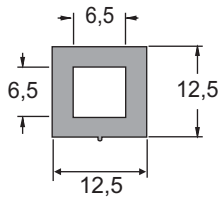
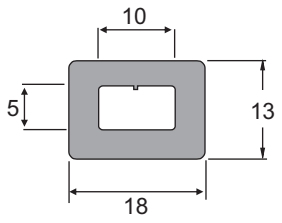
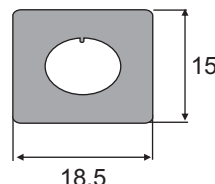
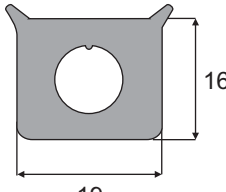
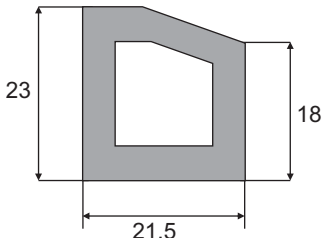
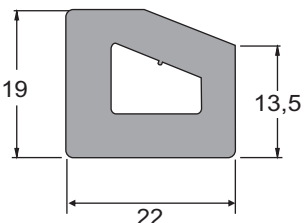
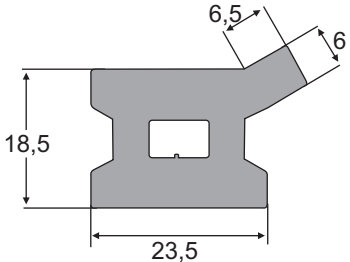
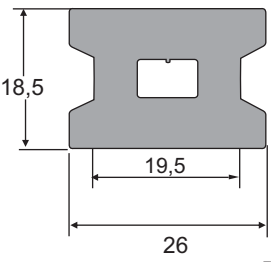
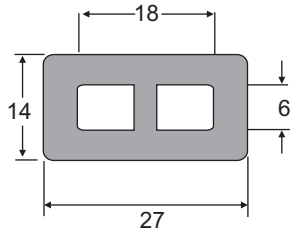
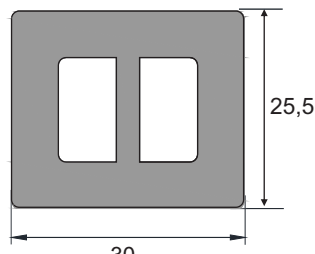
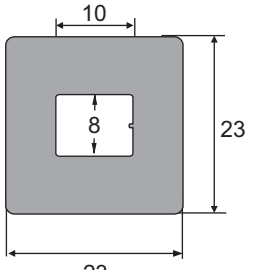
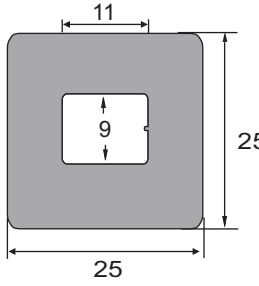
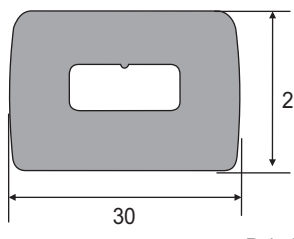

* ITEM NOVO

<p>IBC 1223 SBR 15 Sh A IBC 1513 EPDM 15 Sh A Vedação Quadro de Comando</p>  <p>Rolo 50 m</p>	<p>IBC 1076 SBR 10 Sh A IBC 1451 EPDM 10 Sh A Vedação Quadro de Comando</p>  <p>Rolo 50 m</p>	<p>IBC 1067 SBR 10 Sh A Porta Central Kombi</p>  <p>Rolo 25 m</p>	<p>IBC 1324 SBR 15 Sh A</p>  <p>Rolo 25 m</p>	<p>IBC 1317 EPDM 15 Sh A</p>  <p>Rolo 25 m</p>
<p>IBC 1469 EPDM 20 Sh A</p>  <p>Rolo 25 m</p>	<p>IBC 1031 SBR 10 Sh A Porta Furgão</p>  <p>Rolo 25 m</p>	<p>IBC 1256 SBR 15 Sh A Furgão Iderol</p>  <p>Rolo 25 m</p>	<p>IBC 1258 SBR 15 Sh A IBC 1574 EPDM 15 Sh A Furgão Iderol</p>  <p>Rolo 25 m</p>	<p>IBC 1480 EPDM 20 Sh A</p>  <p>Rolo 25 m</p>
<p>IBC 1580 EPDM 10 Sh A</p>  <p>Rolo 25 m</p>	<p>IBC 1079 SBR 10 Sh A</p>  <p>Rolo 25 m</p>	<p>IBC 1174 SBR 10 Sh A</p>  <p>Rolo 25 m</p>	<p>IBC 1255 EPDM 15 Sh A Furgão Argi</p>  <p>Rolo 25 m</p>	

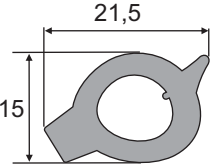
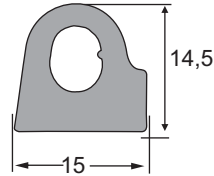
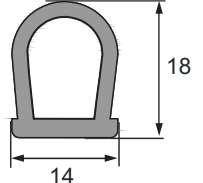
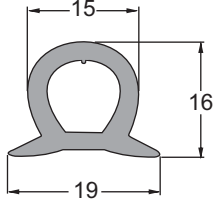
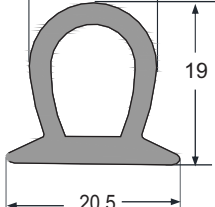
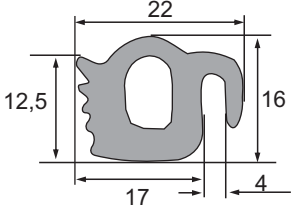
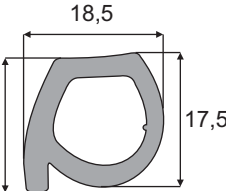
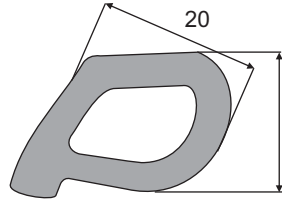
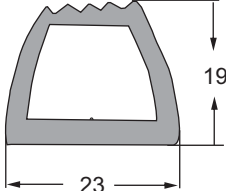
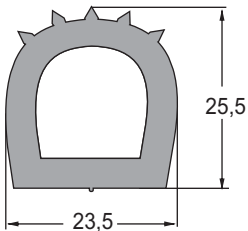
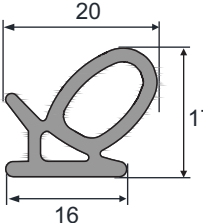
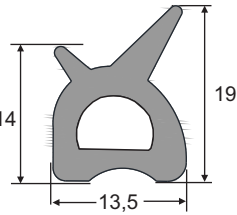
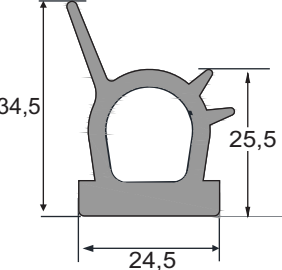
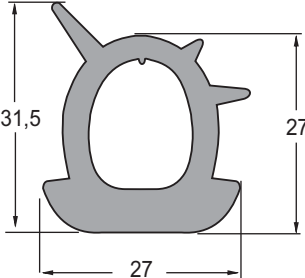
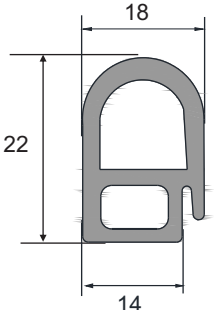
* ITEM NOVO

<p>IBC 1318 EPDM 15 Sh A</p>  <p>21,5 15</p> <p>Rolo 25 m</p>	<p>IBC 1444 EPDM 10 Sh A</p>  <p>14,5 15</p> <p>Rolo 25 m</p>	<p>IBC 1610 EPDM 25 Sh A *</p>  <p>18 14</p> <p>Rolo 25 m</p>	<p>IBC 1112 SBR 15 Sh A Vedação Capota</p>  <p>15 16 19</p> <p>Rolo 25 m</p>	<p>IBC 1584 SBR 25 Sh A *</p>  <p>15 19 20,5</p> <p>Rolo 25 m</p>
<p>IBC 1034 SBR 10 Sh A Porta Mercedes Bens</p>  <p>22 12,5 17 16 4</p> <p>Rolo 50m</p>	<p>IBC1484 EPDM 25 Sh A</p>  <p>18,5 18,5 17,5</p> <p>Rolo 25 m</p>	<p>IBC1443 EPDM 15 Sh A</p>  <p>20 18,5</p> <p>Rolo 25 m</p>	<p>IBC 1514 EPDM 25 Sh A</p>  <p>19 23</p> <p>Rolo 25 m</p>	<p>IBC 1219 EPDM 20 Sh A Vedação Capota</p>  <p>25,5 23,5</p> <p>Rolo 25 m</p>
<p>IBC 1609 EPDM 25 Sh A *</p>  <p>20 17 16</p> <p>Rolo 25 m</p>	<p>IBC1561 EPDM 25 Sh A *</p>  <p>14 19 13,5</p> <p>Rolo 25 m</p>	<p>IBC 1583 EPDM 20 Sh A *</p>  <p>34,5 25,5 24,5</p> <p>Rolo 25 m</p>	<p>IBC 1249 EPDM 15 Sh A</p>  <p>31,5 27 27</p> <p>Rolo 25 m</p>	<p>IBC 1560 EPDM 20 Sh A *</p>  <p>18 22 14</p> <p>Rolo 25 m</p>

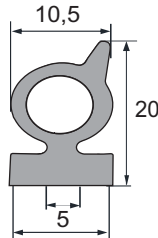
* ITEM NOVO

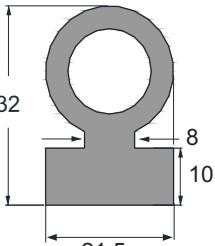
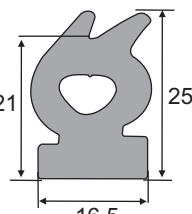
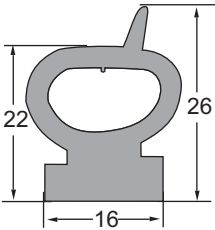
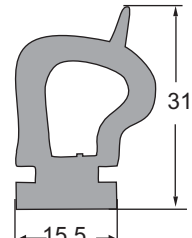
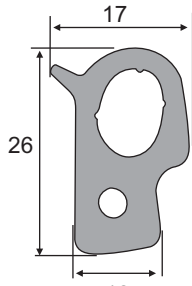
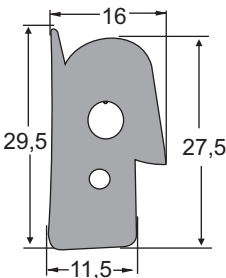
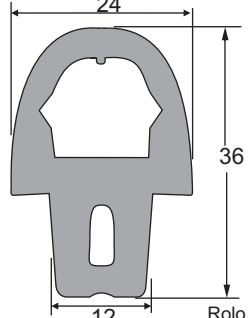
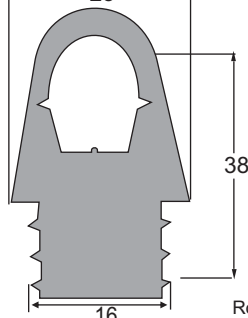
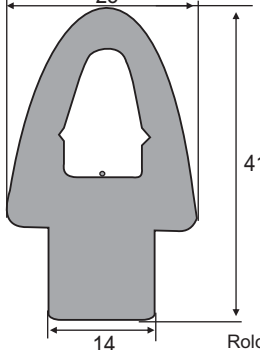
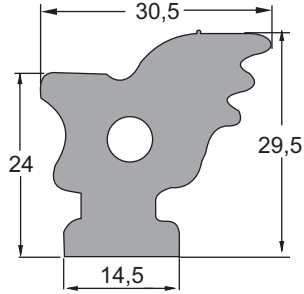
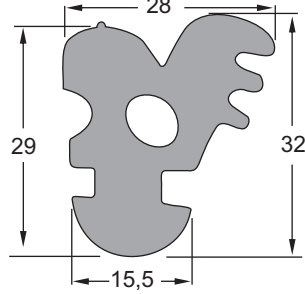
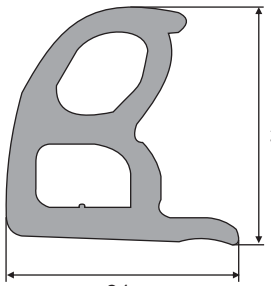
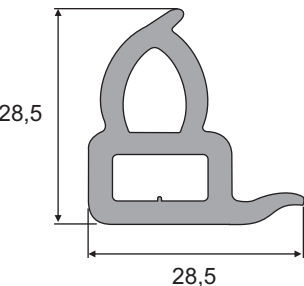
<p>IBC 1540 EPDM 20 Sh A </p>  <p>Rolo 50 m</p>	<p>IBC 1558 EPDM 25 Sh A </p>  <p>Rolo 25 m</p>	<p>IBC 1195 EPDM 15 Sh A Vedação Bagageiro Rodoviário Comil</p>  <p>Rolo 25 m</p>	<p>IBC 1208 EPDM 15 Sh A Vedação Bagageiro Rodoviário Comil</p>  <p>Rolo 25 m</p>	<p>IBC 1203 EPDM 15 Sh A Vedação Bagageiro Rodoviário MP</p>  <p>Rolo 25 m</p>
<p>IBC 1425 EPDM 15 Sh A</p>  <p>Rolo 25 m</p>	<p>IBC 1189 EPDM 15 Sh A Vedação Tampa Traseira Comil</p>  <p>Rolo 25 m</p>	<p>IBC 1194 EPDM 20 Sh A Vedação Capô Motor Comil</p>  <p>Rolo 25 m</p>	<p>IBC 1177 EPDM 15 Sh A Vedação Capô Ônibus MP GV</p>  <p>Rolo 25 m</p>	<p>IBC 1374 EPDM 15 Sh A</p>  <p>Rolo 25 m</p>
<p>IBC 1137 EPDM 10 Sh A Bagageiro Comil</p>  <p>Rolo 25 m</p>	<p>IBC 1108 EPDM 15 Sh A Ved. Bagageiro Ônibus Marcopolo GV, Viaggio e Paradiso</p>  <p>Rolo 25 m</p>	<p>IBC 1130 EPDM 15 Sh A Bagageiro MB 0371 MB 0400</p>  <p>Rolo 25 m</p>	<p>IBC 1282 EPDM 15 Sh A Bagageiro Onibus MB O.370/71 Bagageiro Onibus MB O.400</p>  <p>Rolo 25 m</p>	

 ITEM NOVO

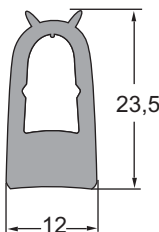
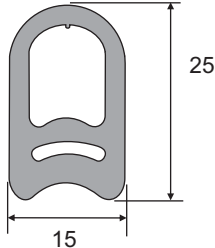
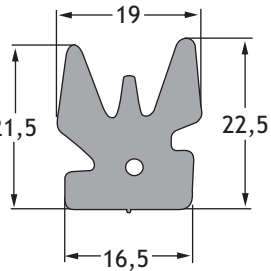
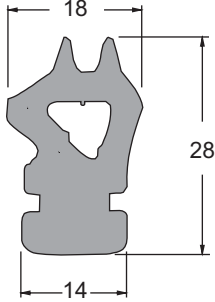
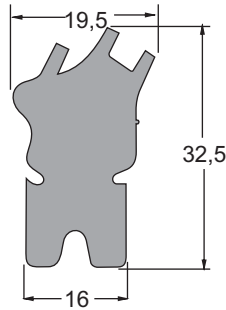
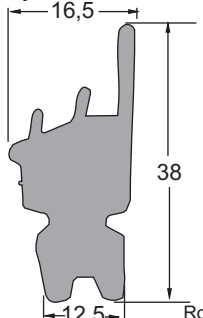
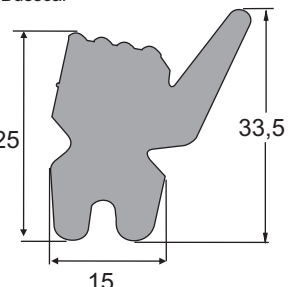
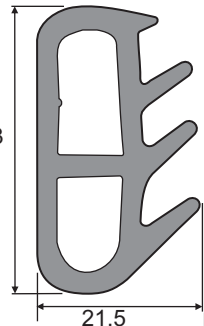
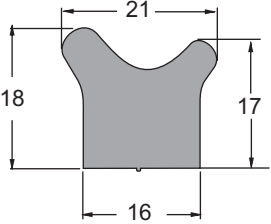
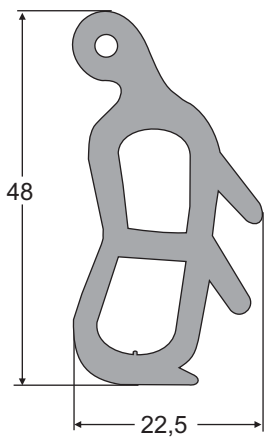
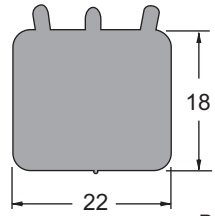
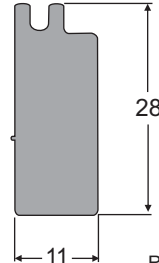
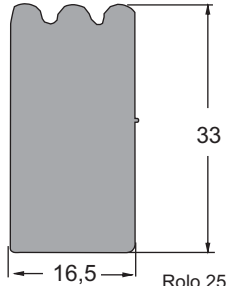
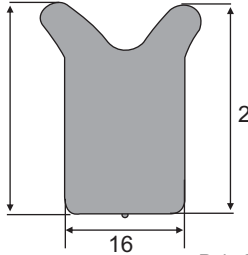
<p>IBC 1188 EPDM 15 Sh A Tampa Geladeira Vedação Painel Ônibus Rodoviário Comil</p>  <p>Rolo 25 m</p>	<p>IBC 1169 EPDM 15 Sh A</p>  <p>Rolo 25 m</p>	<p>IBC 1171 EPDM 15 Sh A Bagageiro Comil</p>  <p>Rolo 25 m</p>	<p>IBC 1105 EPDM 10 Sh A Porta Viaggio MP</p>  <p>Rolo 25 m</p>	<p>IBC 1107 SBR 10 Sh A Bagageiro Viaggio e Paradiso MP</p>  <p>Rolo 25 m</p>
<p>IBC 1129 SBR 10 Sh A - Porta Geração IV MP</p>  <p>Rolo 25 m</p>	<p>IBC 1106 SBR 10 Sh A Porta Rodoviário Elbus/Jumbus Busscar</p>  <p>Rolo 25 m</p>	<p>IBC 1446 EPDM 25 Sh A</p>  <p>Rolo 25 m</p>	<p>IBC 1104 SBR 10 Sh A Bagageiro Ônibus - Diversos</p>  <p>Rolo 25 m</p>	<p>IBC 1193 EPDM 20 Sh A Vedação Inferior Porta Ônibus Rodoviário Comil</p>  <p>Rolo 25 m</p>
<p>IBC 1126 SBR 10 Sh A</p>  <p>Rolo 25 m</p>	<p>IBC 1270 EPDM 20 Sh A</p>  <p>Rolo 25 m</p>	<p>IBC 1144 SBR 10 Sh A Bagageiro Comil</p>  <p>Rolo 25 m</p>	<p>IBC 1382 EPDM 15 Sh A</p>  <p>Rolo 25 m</p>	

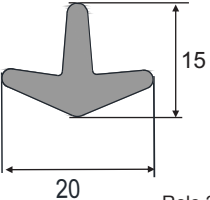
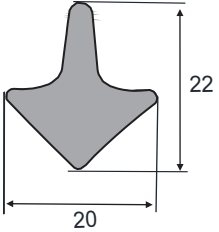
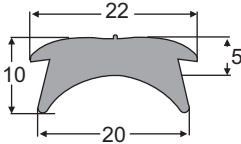
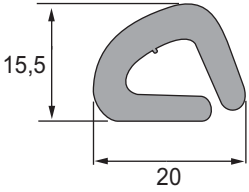
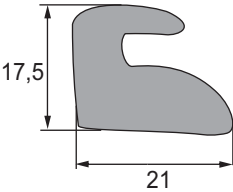
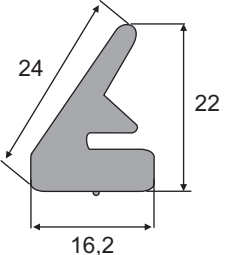
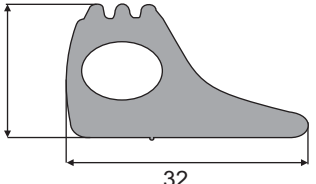
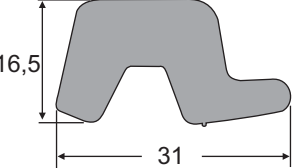
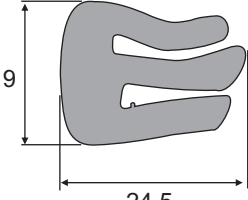
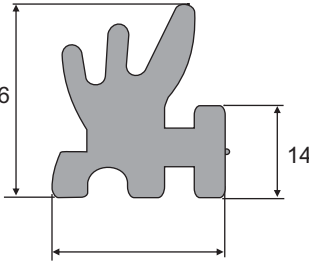
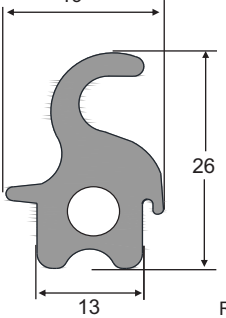
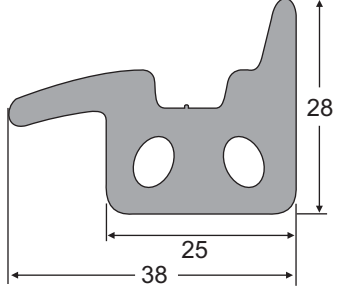
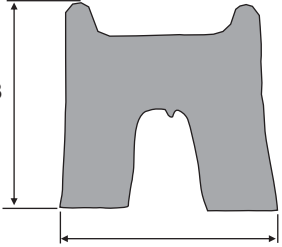
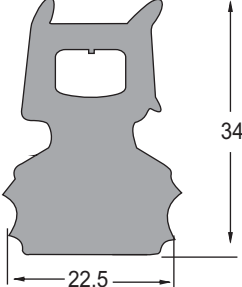
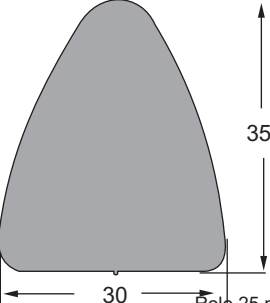
<p>IBC 1563 EPDM 20 Sh A</p>  <p>Rolo 25 m</p>	<p>IBC 1542 EPDM 15 Sh A</p>  <p>Rolo 25 m</p>	<p>IBC 1246 EPDM 20 Sh A Vedação Fecho Retrátil</p>  <p>Rolo 50 m</p>	<p>IBC 1299 SBR 25 Sh A</p>  <p>Rolo 25 m</p>	<p>IBC 1479 EPDM 15 Sh A</p>  <p>Rolo 50 m</p>
<p>IBC 1427 SBR 25 Sh A</p>  <p>Rolo 25 m</p>	<p>IBC 1467 EPDM 15 Sh A Rolo 25 m</p>  <p>Rolo 25 m</p>	<p>IBC 1328 EPDM 15 Sh A</p>  <p>Rolo 25 m</p>	<p>IBC 1313 SBR 25 Sh A</p>  <p>Rolo 25 m</p>	<p>IBC 1428 EPDM 15 Sh A</p>  <p>Rolo 25 m</p>
<p>IBC 1559 EPDM 25 Sh A 19</p>  <p>Rolo 25 m</p>	<p>IBC 1327 EPDM 15 Sh A</p>  <p>Rolo 25 m</p>	<p>IBC 1347 EPDM 15 Sh A Bagageiro</p>  <p>Rolo 25 m</p>	<p>IBC 1376 EPDM 15 Sh A</p>  <p>Rolo 25 m</p>	<p>IBC 1184 SBR 10 Sh A Prensa Cabos Quadro de Comando</p>  <p>Rolo 25 m</p>

* ITEM NOVO

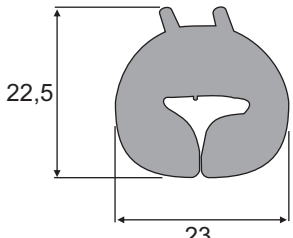
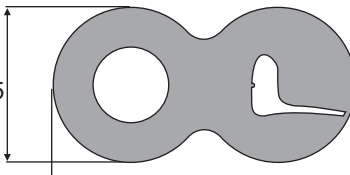
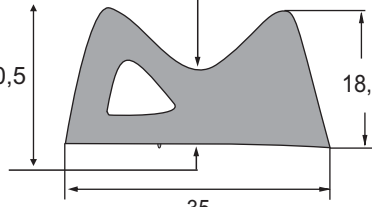
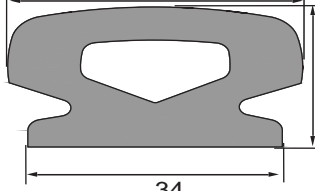
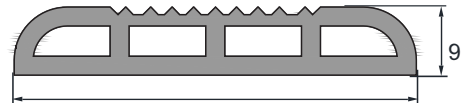
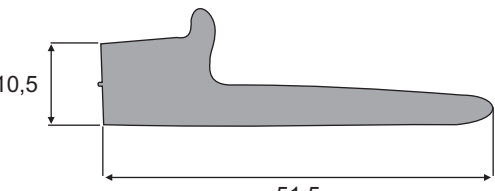
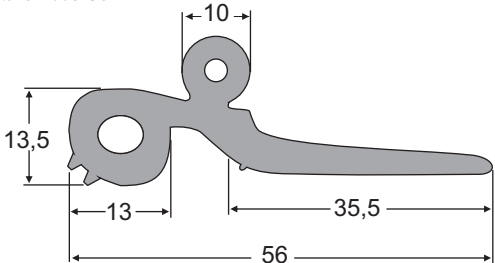
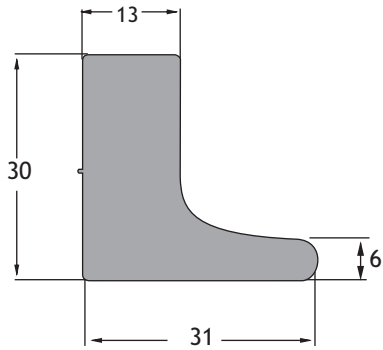
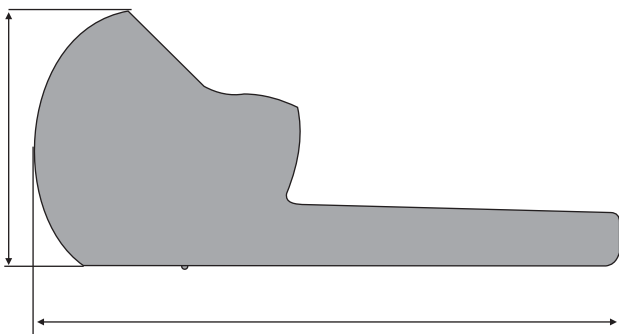
<p>IBC 1297 SBR 25 Sh A</p>  <p>22,5</p> <p>23</p> <p>Rolo 25 m</p>	<p>IBC 1301 SBR 25 Sh A</p>  <p>20,5</p> <p>40</p> <p>Rolo 25 m</p>	<p>IBC 1221 EPDM 15 Sh A</p>  <p>10,5</p> <p>18,5</p> <p>35</p> <p>Rolo 25 m</p>	<p>IBC 1593 EPDM 15 Sh A</p>  <p>39</p> <p>25,5</p> <p>34</p> <p>Rolo 25 m</p>
<p>IBC 1594 EPDM 20 Sh A</p>  <p>9</p> <p>53</p> <p>Rolo 25 m</p>	<p>IBC 1302 EPDM 25 Sh A</p>  <p>10,5</p> <p>51,5</p> <p>Rolo 25 m</p>	<p>IBC 1191 EPDM 15 Sh A Vedação Porta Ônibus Comil</p>  <p>10</p> <p>13,5</p> <p>13</p> <p>35,5</p> <p>56</p> <p>Rolo 25 m</p>	
<p>IBC 1250 SBR 15 Sh A Vedação Cabine Máquina Agrícola</p>  <p>13</p> <p>30</p> <p>31</p> <p>6</p> <p>Rolo 25 m</p>	<p>IBC 1369 SBR 25 Sh A Vedação Máquina Secadora de Couros</p>  <p>33</p> <p>77</p> <p>Rolo 25 m</p>		

* ITEM NOVO

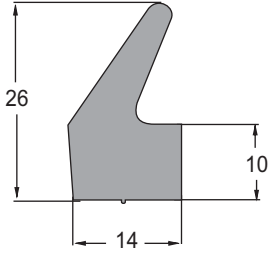
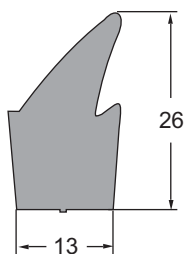
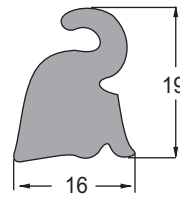
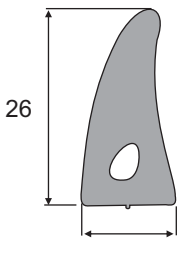
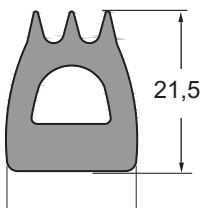
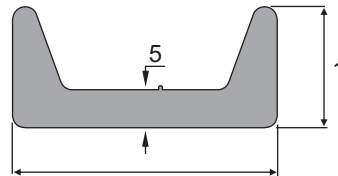
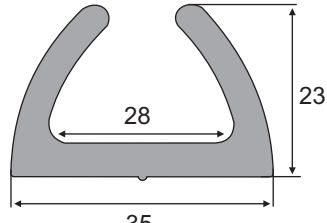
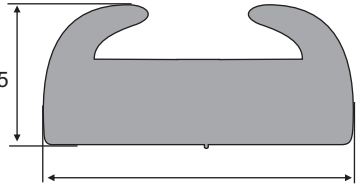
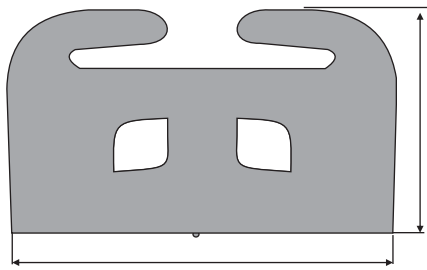
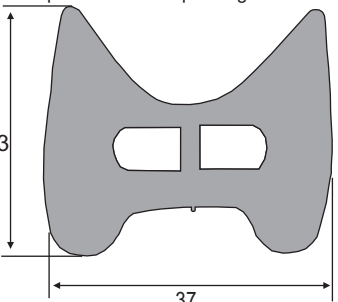
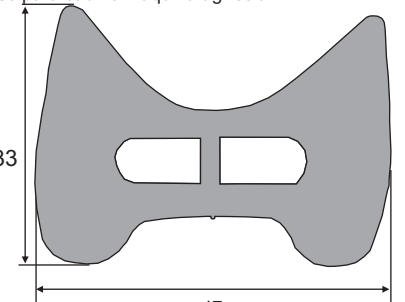
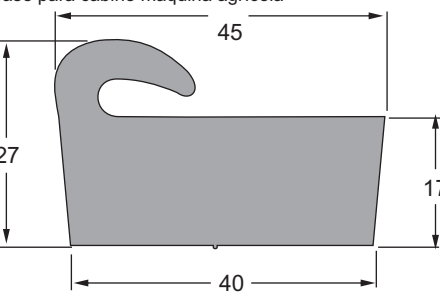
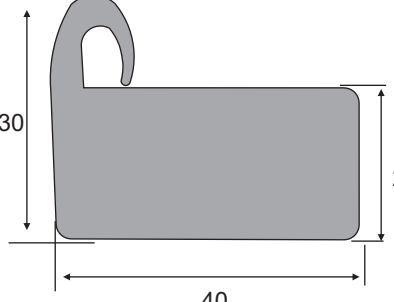
<p>IBC 1251 EPDM 15 Sh A</p>  <p>Rolo 25 m</p>	<p>IBC 1207 SBR 10 Sh A Tampa Painel Marcopolo</p>  <p>Rolo 50 m</p>	<p>IBC 1234 SBR 15 Sh A</p>  <p>Rolo 50 m</p>	<p>IBC 1314 SBR 15 Sh A</p>  <p>Rolo 25 m</p>	<p>IBC 1570 EPDM 15 Sh A *</p>  <p>Rolo 25 m</p>
<p>IBC 1260 SBR 15 Sh A</p>  <p>Rolo 25 m</p>	<p>IBC 1435 EPDM 25 Sh A</p>  <p>Rolo 25 m</p>	<p>IBC 1323 EPDM 15 Sh A Base para cabine máquina agrícola</p>  <p>Rolo 25 m</p>	<p>IBC 1432 EPDM 15 Sh A Base para cabine máquina agrícola</p>  <p>Rolo 25 m</p>	
<p>IBC 1332 EPDM 15 Sh A Base para cabine máquina agrícola</p>  <p>Rolo 25 m</p>	<p>IBC 1333 EPDM 15 Sh A Base para cabine máquina agrícola</p>  <p>Rolo 25 m</p>	<p>IBC 1252 EPDM 15 Sh A Base para cabine máquina agrícola</p>  <p>Rolo 25 m</p>	<p>IBC 1568 EPDM 10 Sh A *</p>  <p>Rolo 25 m</p>	

* ITEM NOVO

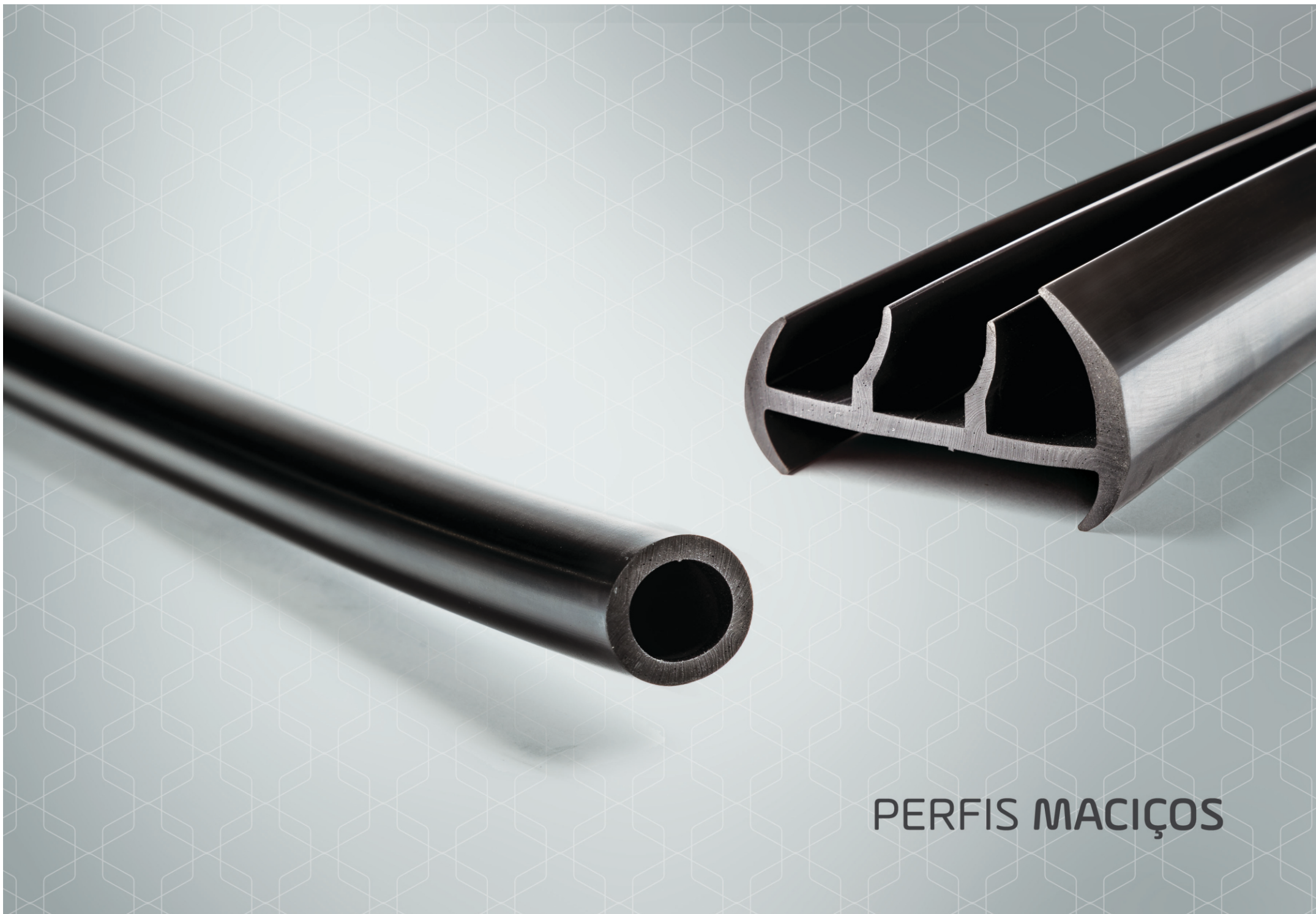









PERFIS MACIÇOS



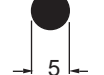
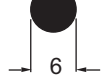
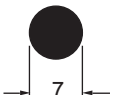
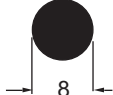

ACONDICIONAMENTO DOS CORDÕES MACIÇOS

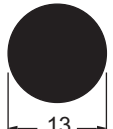
ϕ mm	m/rolo	Frações/rolo
3 a 6	150	3 x 50 m
7 a 9	75	3 x 25 m
10 a 13	50	2 x 25 m
14 a 25	25	Inteiro







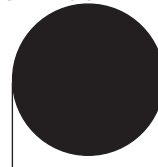
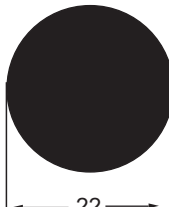
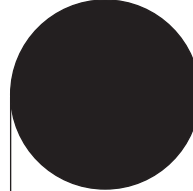
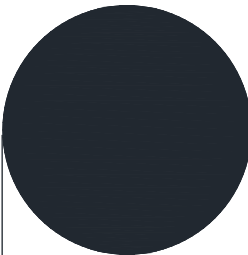
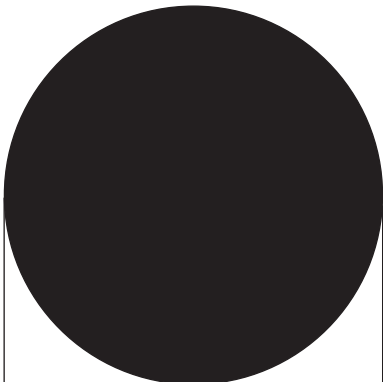
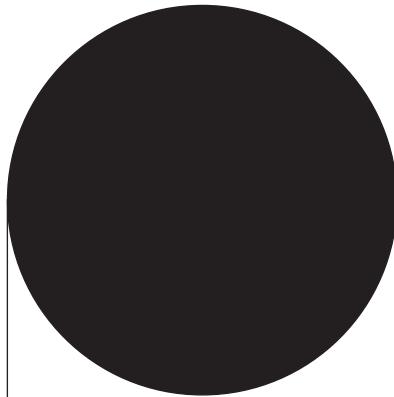









TABELA DE TOLERÂNCIAS

COTA mm	COTA (mm)	até 5	6 a 10	11 a 15	16 a 20	21 a 30	31 a 50	51 a 80	81 a 120	121 a 180
MACIÇA	MACIÇA	± 0,2	± 0,3	± 0,4	± 0,5	± 0,7	± 1,0	± 1,2	± 1,4	± 1,6
ESPONJA	ESPONJA	± 0,3	± 0,4	± 0,5	± 0,8	± 1,0	± 1,5	± 2,0	± 2,5	± 3,0











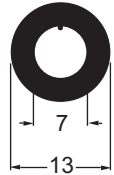
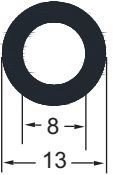

<p>IBC 3029 NBR 70 Sh A IBC 3158 EPDM 70 Sh A</p>  <p>Rolo150 m</p>	<p>IBC 3020 NBR 70 Sh A IBC 3168 SBR 70 Sh A</p>  <p>Rolo150 m</p>	<p>IBC 3021 NBR 70 Sh A IBC 3028 SBR 70 Sh A</p>  <p>Rolo150 m</p>	<p>IBC 3023 NBR 70 Sh A</p>  <p>Rolo150 m</p>
<p>IBC 3025 NBR 70 Sh A</p>  <p>Rolo 75 m</p>	<p>IBC 3019 NBR 70 Sh A IBC 3004 SBR 70 Sh A</p>  <p>Rolo 75 m</p>	<p>IBC 3026 NBR 70 Sh A</p>  <p>Rolo 75 m</p>	<p>IBC 3027 NBR 70 Sh A</p>  <p>Rolo 50 m</p>
<p>IBC 3142 NBR 70 Sh A</p>  <p>Rolo 50 m</p>	<p>IBC 3112 NBR 70 Sh A</p>  <p>Rolo 50 m</p>	<p>IBC 3094 NBR 70 Sh A IBC 3414 SBR 70 Sh A</p>  <p>Rolo 50 m</p>	<p>IBC 3178 NBR 70 Sh A IBC 3393 SBR 70 Sh A</p>  <p>Rolo 25 m</p>

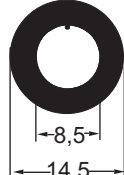
<p>IBC 3116 NBR 70 Sh A IBC 3280 SBR 70 Sh A</p>  <p>15</p> <p>Rolo 25 m</p>	<p>IBC 3179 NBR 70 Sh A IBC 3368 SBR 70 Sh A</p>  <p>16</p> <p>Rolo 25 m</p>	<p>IBC 3180 NBR 70 Sh A IBC 3281 SBR 70 Sh A</p>  <p>17</p> <p>Rolo 25 m</p>	<p>IBC 3181 NBR 70 Sh A IBC 3380 SBR 70 Sh A</p>  <p>18</p> <p>Rolo 25 m</p>
<p>IBC 3092 NBR 70 Sh A</p>  <p>19</p> <p>Rolo 25 m</p>	<p>IBC 3182 NBR 70 Sh A IBC 3200 SBR 70 Sh A</p>  <p>20</p> <p>Rolo 25 m</p>	<p>IBC 3537 NBR 70 Sh A</p>  <p>22</p> <p>Rolo 25 m</p> <p style="text-align: right;">✱</p>	<p>IBC 3099 NBR 70 Sh A IBC 3394 SBR 70 Sh A</p>  <p>25</p> <p>Rolo 25 m</p>
<p>IBC 3635 SBR 80 Sh A</p>  <p>32</p> <p>Rolo 25 m</p> <p style="text-align: right;">✱</p>	<p>IBC 3463 EPDM 75 Sh A</p>  <p>50</p> <p>Rolo 15 m</p>	<p>IBC 3500 NBR 80 Sh A</p>  <p>51,5</p> <p>Rolo 15 m</p>	

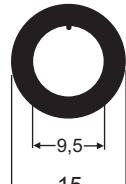





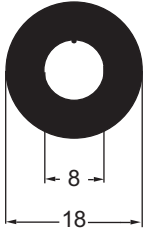
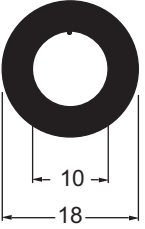
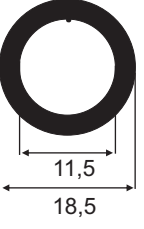

✱ ITEM NOVO

IBC 3134 NBR 70 Sh A  Rolo 100 m	IBC 3066 SBR 70 Sh A IBC 3155 NBR 65 Sh A  Rolo 100 m	IBC 3558 NBR 70 Sh A  Rolo 100 m	IBC 3133 NBR 70 Sh A  Rolo 100 m
IBC 3058 NBR 70 Sh A  Rolo 50 m	IBC 3060 NBR 70 Sh A IBC 3372 SBR 70 Sh A  Rolo 50 m	IBC 3047 SBR 70 Sh A IBC 3507 NBR 70 Sh A IBC 3067 EPDM 65 Sh A  Rolo 50 m	IBC 3067 EPDM 65 Sh A  Rolo 50 m
IBC 3057 NBR 70 Sh A  Rolo 50 m	IBC 3061 NBR 70 Sh A IBC 3219 EPDM 75 Sh A  Rolo 50 m	IBC 3059 NBR 70 Sh A  Rolo 50 m	IBC 3188 EPDM 70 Sh A  Rolo 50 m
IBC 3114 SBR 60 Sh A IBC 3157 NBR 70 Sh A  Rolo 50 m	IBC 3175 EPDM 70 Sh A  Rolo 25 m	IBC 3062 NBR 70 Sh A  Rolo 50 m	IBC 3465 EPDM 65 Sh A  Rolo 50 m







 ITEM NOVO

IBC 3095 SBR 60 Sh A IBC 3489 EPDM 60 Sh A Ordenhadeira  Rolo 50 m	IBC 3625 NBR 70 Sh A  Rolo 50 m	IBC 3511 SBR 60 Sh A Ordenhadeira  Rolo 50 m	IBC 3618 NBR 75 Sh A  Rolo 25 m
IBC 3110 SBR 60 Sh A IBC 3498 EPDM 65 Sh A Ordenhadeira  Rolo 50 m	IBC 3299 EPDM 70 Sh A  Rolo 25 m	IBC 3430 EPDM 70 Sh A  Rolo 25 m	IBC 3429 SBR 60 Sh A  Rolo 25 m
IBC 3197 SBR 60 Sh A IBC 3212 SBR 70 Sh A  Rolo 25 m	IBC 3607 NBR 70 Sh A  Rolo 25 m	IBC 3665 EPDM 75 Sh A  Rolo 25 m	IBC 3274 NBR 70 Sh A IBC 3285 SBR 70 Sh A  Rolo 25 m
IBC 3298 EPDM 70 Sh A IBC 3472 SBR 70 Sh A IBC 3551 NBR 70 Sh A  Rolo 25 m	IBC 3105 EPDM 65 Sh A Mangueira Jardim  Rolo 25 m	IBC 3541 NBR 75 Sh A IBC 3577 EPDM 75 Sh A  Rolo 25 m	

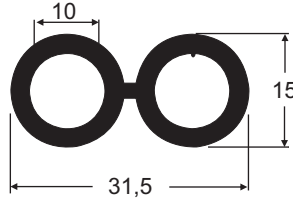
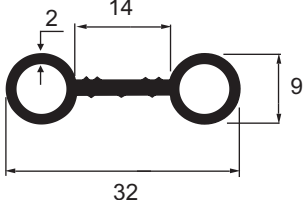
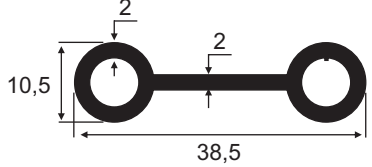
* ITEM NOVO

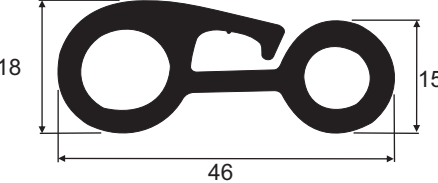

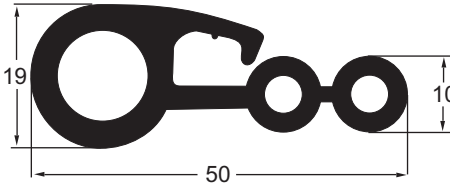



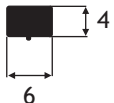
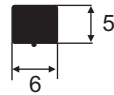
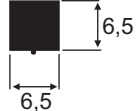
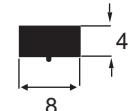
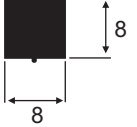
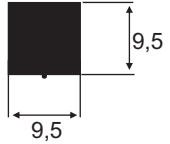
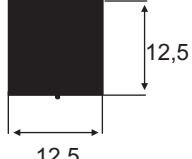
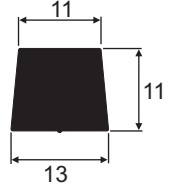
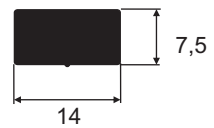
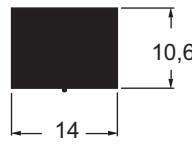
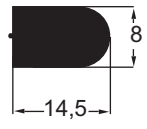
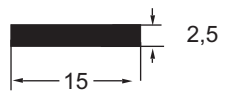
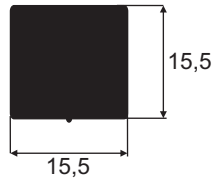
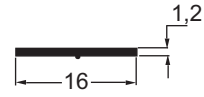
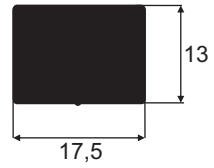
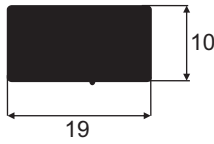
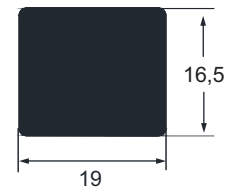

<p>IBC 3170 SBR 60 Sh A</p>  <p>Rolo 25 m</p>	<p>IBC 3125 NBR 70 Sh A IBC 3218 EPDM 70 Sh A</p>  <p>Rolo 25 m</p>	<p>IBC 3300 EPDM 70 Sh A</p>  <p>Rolo 25 m</p>	<p>IBC 3177 SBR 60 Sh A Ordenhadeira</p>  <p>Rolo 25 m</p>
<p>IBC 3089 SBR 60 Sh A Ordenhadeira</p>  <p>Rolo 25 m</p>	<p>IBC 3096 SBR 60 Sh A IBC 3401 NBR 70 Sh A Ordenhadeira</p>  <p>Rolo 25 m</p>	<p>IBC 3127 EPDM 65 Sh A IBC 3124 NBR 70 Sh A</p>  <p>Rolo 25 m</p>	<p>IBC 3108 SBR 60 Sh A Ordenhadeira</p>  <p>Rolo 25 m</p>
<p>IBC 3672 EPDM 65 Sh A</p>  <p>Rolo 25 m</p>	<p>IBC 3126 NBR 70 Sh A</p>  <p>Rolo 25 m</p>	<p>IBC 3671 EPDM 65 Sh A</p>  <p>Rolo 25 m</p>	

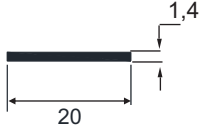
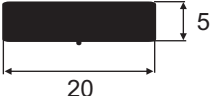
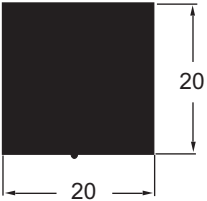
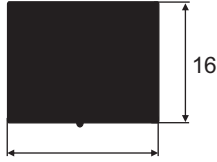
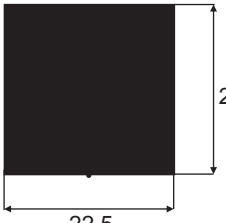
* ITEM NOVO

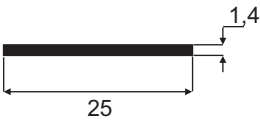

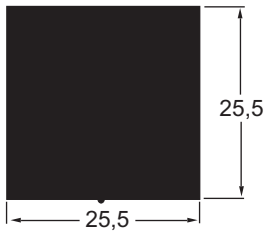
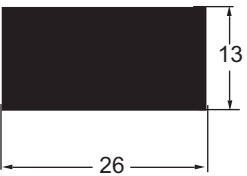
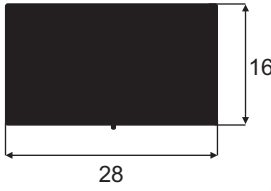

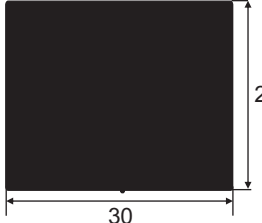

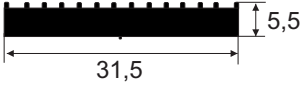

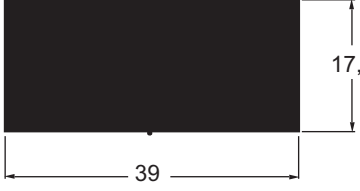
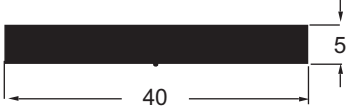

<p>IBC 3109 SBR 60 Sh A IBC 3490 EPDM 65 Sh A Ordenhadeira</p>  <p>Rolo 50 m</p>	<p>IBC 3312 SBR 60 Sh A IBC 3333 SBR 70 Sh A</p>  <p>Rolo 25 m</p>	<p>IBC 3012 SBR 70 Sh A Base Chassi VW</p>  <p>Rolo 25 m</p>	<p>IBC 3420 SBR 70 Sh A</p>  <p>Rolo 25 m</p>
<p>IBC 3035 EPDM 60 Sh A</p>  <p>Rolo 75 m</p>	<p>IBC 3308 EPDM 75 Sh A</p>  <p>Rolo 25 m</p>	<p>IBC 3138 SBR 80 Sh A Retorno Resfriador</p>  <p>Rolo 24,6 m</p>	<p>IBC 3369 SBR 80 Sh A Retorno Resfriador</p>  <p>Rolo 25 m</p>
<p>IBC 3513 EPDM 80 Sh A</p>  <p>Rolo 25 m</p>			

<p>IBC 3319 NBR 70 Sh A</p>  <p>Rolo 100 m</p>	<p>IBC 3236 NBR 70 Sh A</p>  <p>Rolo 100 m</p>	<p>IBC 3013 NBR 70 Sh A</p>  <p>Rolo 100 m</p>	<p>IBC 3215 EPDM 65 Sh A</p>  <p>Rolo 100 m</p>	<p>IBC 3014 NBR 70 Sh A</p>  <p>Rolo 50 m</p>
<p>IBC 3015 NBR 70 Sh A</p>  <p>Rolo 50 m</p>	<p>IBC 3016 NBR 70 Sh A</p>  <p>Rolo 50 m</p>	<p>IBC 3450 SBR 70 Sh A</p>  <p>Rolo 50 m</p>	<p>IBC 3461 SBR 70 Sh A</p>  <p>Rolo 50 m</p>	
<p>IBC 3017 NBR 70 Sh A</p>  <p>Rolo 50 m</p>	<p>IBC 3073 EPDM 75 Sh A</p>  <p>Rolo 50 m</p>	<p>IBC 3030 SBR 70 Sh A</p>  <p>Rolo 100 m</p>	<p>IBC 3162 SBR 70 Sh A IBC 3165 NBR 70 Sh A</p>  <p>Rolo 25 m</p>	
<p>IBC 3085 EPDM 65 Sh A</p>  <p>Rolo 100 m</p>	<p>IBC 3053 SBR 70 Sh A</p>  <p>Rolo 25 m</p>	<p>IBC 3453 EPDM 65 Sh A</p>  <p>Rolo 25 m</p>	<p>IBC 3623 EPDM 65 Sh A</p>  <p>Rolo 25 m</p>	

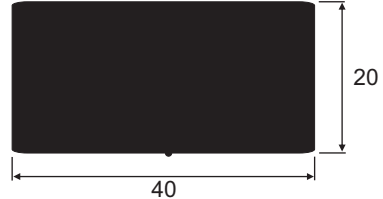
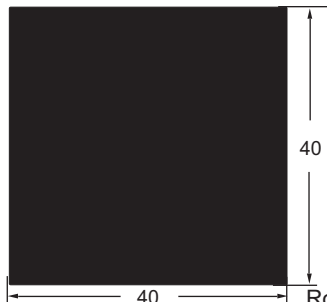

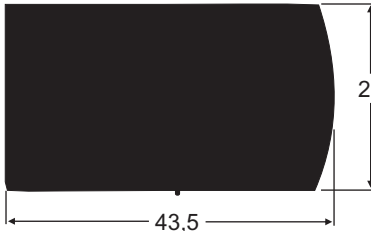
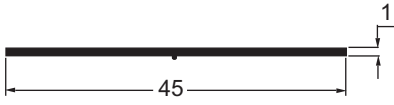
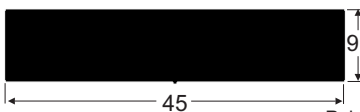

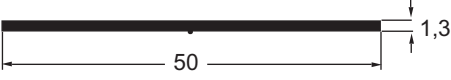



* ITEM NOVO

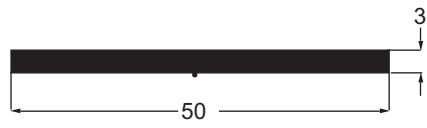

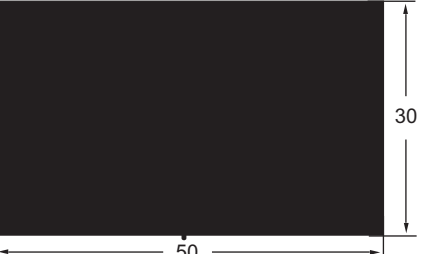

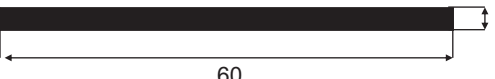
<p>IBC 3586 EPDM 70 Sh A</p>  <p>Rolo 100 m</p>	<p>IBC 3276 EPDM 65 Sh A</p>  <p>Rolo 50 m</p>	<p>IBC 3163 SBR 70 Sh A IBC 3166 NBR 70 Sh A</p>  <p>Rolo 25 m</p>	<p>IBC 3255 EPDM 70 Sh A</p>  <p>Rolo 25 m</p>
<p>IBC 3516 SBR 70 Sh A IBC 3517 EPDM 70 Sh A</p>  <p>Rolo 25 m</p>	<p>IBC 3031 NBR 70 Sh A IBC 3258 EPDM 70 Sh A</p>  <p>Rolo 50 m</p>	<p>IBC 3497 EPDM 70 Sh A</p>  <p>Rolo 100 m</p>	<p>IBC 3078 SBR 70 Sh A</p>  <p>Rolo 25 m</p>
<p>IBC 3164 SBR 70 Sh A IBC 3167 NBR 70 Sh A</p>  <p>Rolo 25 m</p>	<p>IBC 3576 EPDM 65 Sh A</p>  <p>Rolo 25 m</p>	<p>IBC 3254 EPDM 70 Sh A</p>  <p>Rolo 25 m</p>	<p>IBC 3293 SBR 70 Sh A IBC 3341 EPDM 65 Sh A IBC 3579 NBR 70 Sh A</p>  <p>Rolo 50m</p>
<p>IBC 3360 SBR 70 Sh A</p>  <p>Rolo 25 m</p>	<p>IBC 3624 EPDM 70 Sh A</p>  <p>Rolo 15 m</p>	<p>IBC 3555 EPDM 80 Sh A</p>  <p>Rolo 50m</p>	

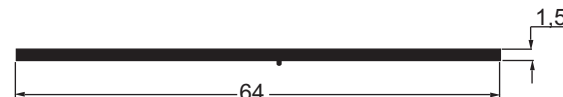

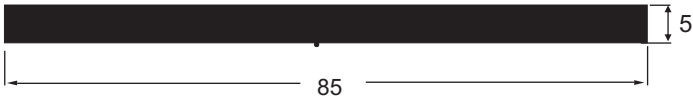

* ITEM NOVO

<p>IBC 3681 NBR 70 Sh A</p>  <p>Rolo 50 m</p>	<p>IBC 3032 SBR 70 Sh A IBC 3121 EPDM 65 Sh A</p>  <p>Rolo 50 m</p>	<p>IBC 3043 EPDM 65 Sh A <u>IBC 3566 SBR 70 Sh A</u></p>  <p>Rolo 15 m</p>	<p>IBC 3044 EPDM 65 Sh A</p>  <p>Rolo 15 m</p>
<p>IBC 3294 SBR 70 Sh A IBC 3342 EPDM 65 Sh A</p>  <p>Rolo 25 m</p>	<p>IBC 3376 NBR 70 Sh A</p>  <p>Rolo 25 m</p>	<p>IBC 3441 SBR 70 Sh A</p>  <p>Rolo 25 m</p>	
<p>IBC 3554 SBR 70 Sh A</p>  <p>Rolo 10 m</p>	<p>IBC 3082 SBR 70 Sh A IBC 3203 EPDM 65 Sh A</p>  <p>Rolo 50 m</p>	<p>IBC 3248 SBR 80 Sh A</p>  <p>Rolo 15 m</p>	<p>IBC 3005 EPDM 65 Sh A</p>  <p>Rolo 100 m</p>
<p>IBC 3425 EPDM 80 Sh A <u>IBC 3563 NBR 75 Sh A</u></p>  <p>Rolo 25 m</p>	<p>IBC 3042 EPDM 65 Sh A IBC 3484 EPDM 70 Sh A</p>  <p>Rolo 15 m</p>	<p>IBC 3499 EPDM 70 Sh A</p>  <p>Rolo 100 m</p>	<p>IBC 3113 SBR 70 Sh A</p>  <p>Rolo 50 m</p>

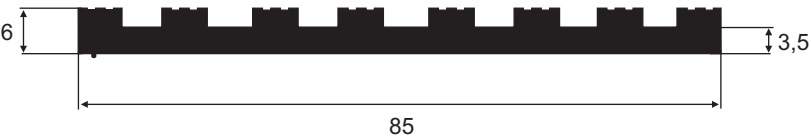
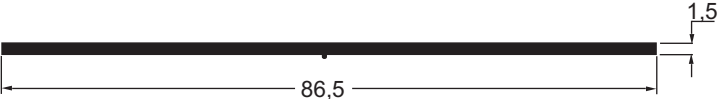
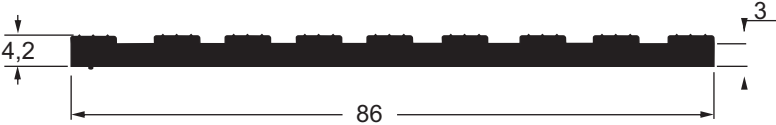

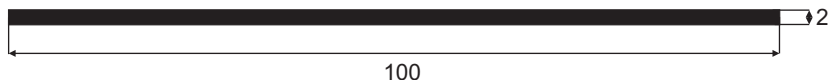
* ITEM NOVO

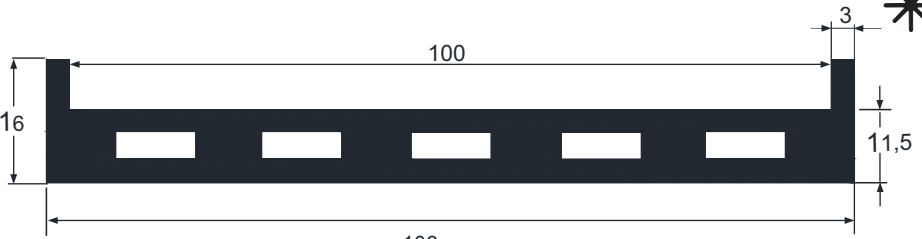
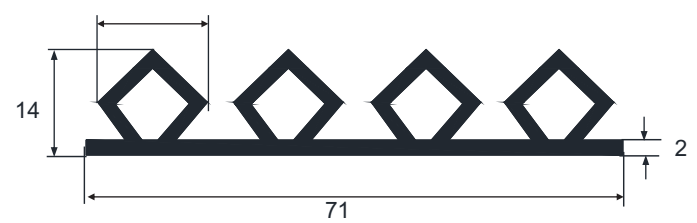
<p>IBC 3002 SBR 70 Sh A IBC 3439 EPDM 80 Sh A</p>  <p>Rolo 50 m</p>	<p>IBC 3337 SBR 70 Sh A IBC 3343 EPDM 65 Sh A</p>  <p>Rolo 25 m</p>	<p>IBC 3303 NBR 70 Sh A IBC 3304 SBR 70 Sh A</p>  <p>Rolo 15 m</p>
<p>IBC 3338 SBR 70 Sh A IBC 3344 EPDM 65 Sh A</p>  <p>Rolo 25 m</p>	<p>IBC 3076 EPDM 65 Sh A</p>  <p>Rolo 15 m</p>	<p>IBC 3481 SBR 70 Sh A</p>  <p>Rolo 25 m</p>
<p>IBC 3339 SBR 70 Sh A IBC 3345 EPDM 65 Sh A</p>  <p>Rolo 25 m</p>	<p>IBC 3522 SBR 70 Sh A</p>  <p>Rolo 15 m</p>	<p>IBC 3074 SBR 80 Sh A</p>  <p>Rolo 100 m</p>
<p>IBC 3077 EPDM 65 Sh A</p>  <p>Rolo 15 m</p>		

<p>IBC 3340 SBR 70 Sh A IBC 3346 EPDM 65 Sh A</p>  <p>Rolo 25 m</p>	<p>IBC 3388 SBR 70 Sh A</p>  <p>Rolo 15 m</p>
<p>IBC 3301 SBR 80 Sh A</p>  <p>Rolo 15 m</p>	<p>IBC 3302 SBR 80 Sh A</p>  <p>Rolo 15 m</p>
<p>IBC 3222 SBR 60 Sh A</p>  <p>Rolo 25 m</p>	<p>IBC 3091 SBR 80 Sh A</p>  <p>Rolo 50 m</p>
<p>IBC 3006 SBR 70 Sh A</p>  <p>Rolo 25 m</p>	

<p>IBC 3485 EPDM 65 Sh A</p>  <p>Rolo 25 m</p>	<p>IBC 3633 EPDM 75 Sh A</p>  <p>Rolo 25 m</p>
<p>IBC 3634 SBR 80 Sh A</p>  <p>Rolo 10 m</p>	<p>IBC 3675 EPDM 75 Sh A</p>  <p>Rolo 25 m</p>
<p>IBC 3621 SBR 70 Sh A</p>  <p>Rolo 15 m</p>	

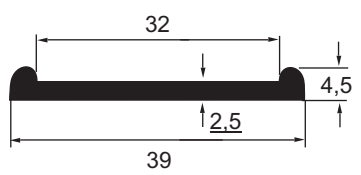
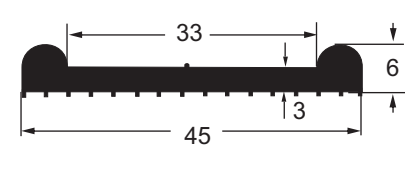
* ITEM NOVO

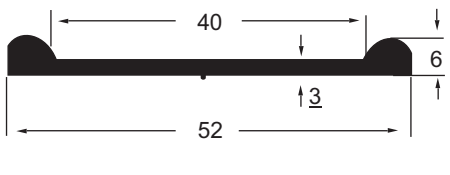
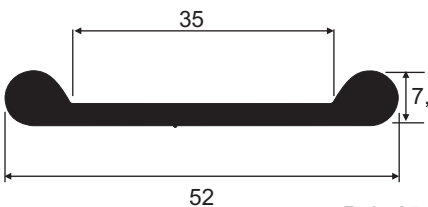
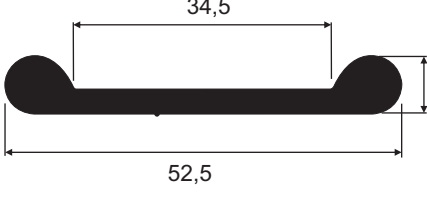
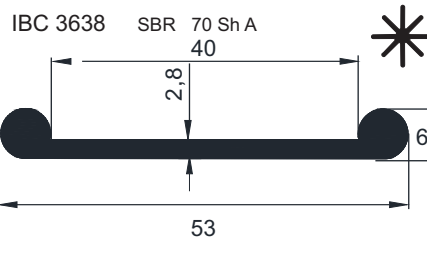
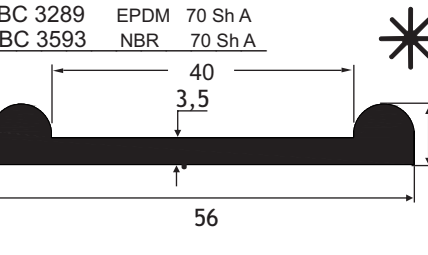
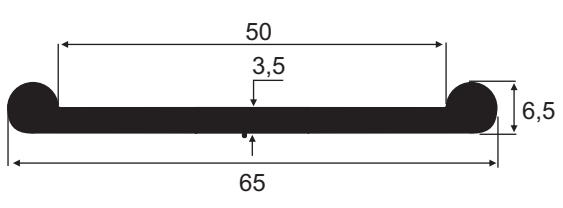
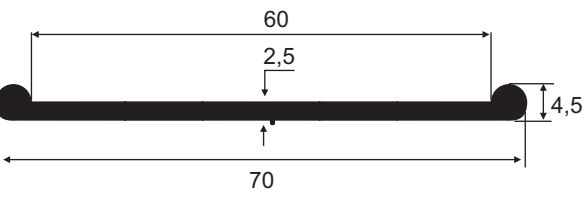
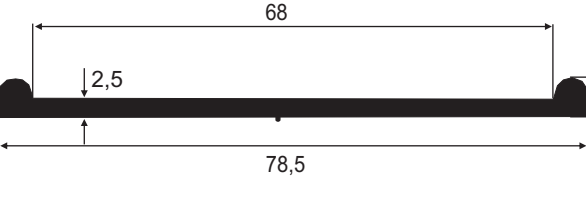
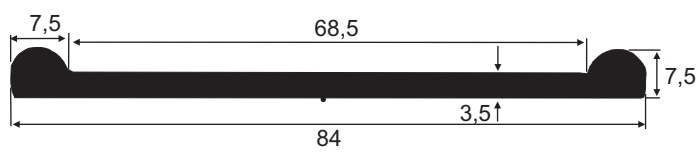
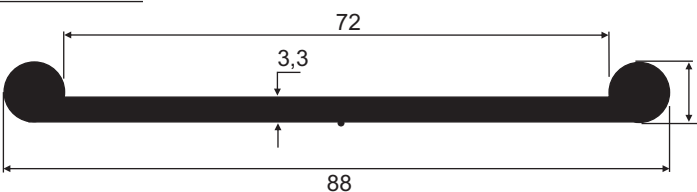
<p>IBC 3418 SBR 70 Sh A</p>  <p>Rolo 50 m</p>	<p>IBC 3169 EPDM 65 Sh A IBC 3266 NBR 70 Sh A</p>  <p>Rolo 25 m</p>	<p>IBC 3639 SBR 70 Sh A</p>  <p>Rolo 25 m</p>	<p>IBC 3034 SBR 70 Sh A IBC 3267 NBR 70 Sh A</p>  <p>Rolo 25 m</p>
<p>IBC 3458 EPDM 70 Sh A</p>  <p>Rolo 25m</p>	<p>IBC 3459 NBR 70 Sh A</p>  <p>Rolo 25m</p>	<p>IBC 3638 SBR 70 Sh A</p>  <p>Rolo 25m</p>	<p>IBC 3289 EPDM 70 Sh A IBC 3593 NBR 70 Sh A</p>  <p>Rolo 25 m</p>
<p>IBC 3257 NBR 70 Sh A</p>  <p>Rolo 25 m</p>	<p>IBC 3256 NBR 70 Sh A</p>  <p>Rolo 25 m</p>	<p>IBC 3282 NBR 70 Sh A</p>  <p>Rolo 25 m</p>	
<p>IBC 3286 NBR 70 Sh A</p>  <p>Rolo 25 m</p>	<p>IBC 3415 NBR 70 Sh A IBC 3501 SBR 70 Sh A</p>  <p>Rolo 25 m</p>		

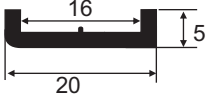
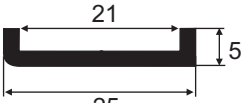
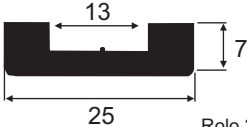
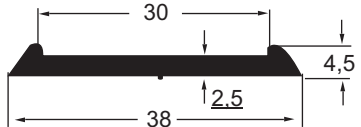
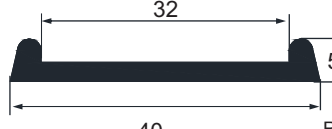
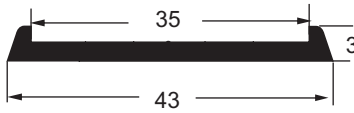
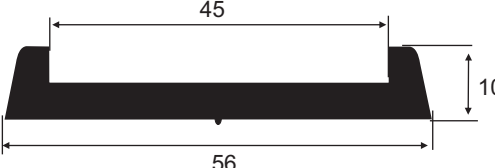
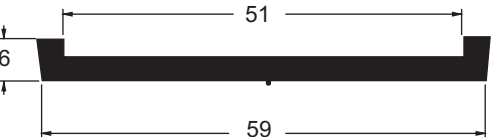
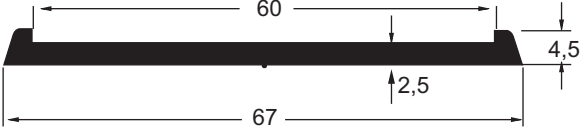
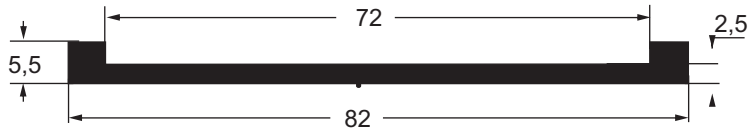
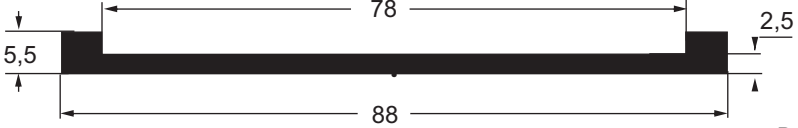
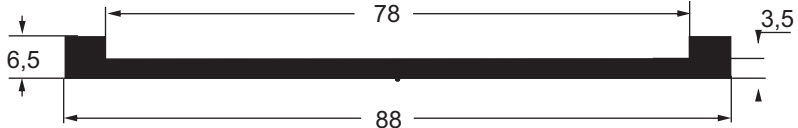
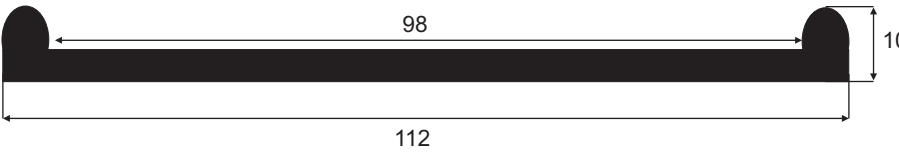

* ITEM NOVO

<p>IBC 3246 SBR 70 Sh A</p>  <p>Rolo 50 m</p>	<p>IBC 3245 SBR 70 Sh A</p>  <p>Rolo 50 m</p>	<p>IBC 3377 SBR 80 Sh A</p>  <p>Rolo 25 m</p>	<p>IBC 3033 SBR 60 Sh A</p>  <p>Rolo 50 m</p>
<p>IBC 3606 EPDM 65 Sh A</p>  <p>Rolo 50 m</p>	<p>IBC 3316 EPDM 70 Sh A</p>  <p>Rolo 50 m</p>	<p>IBC 3419 EPDM 75 Sh A</p>  <p>Rolo 25 m</p>	
<p>IBC 3051 SBR 70 Sh A IBC 3268 NBR 70 Sh A</p>  <p>Rolo 30 m</p>		<p>IBC 3122 EPDM 65 Sh A IBC 3269 NBR 70 Sh A</p>  <p>Rolo 50 m</p>	
<p>IBC 3083 EPDM 75 Sh A IBC 3270 NBR 70 Sh A</p>  <p>Rolo 25 m</p>	<p>IBC 3111 EPDM 75 Sh A</p>  <p>Rolo 25 m</p>		
<p>IBC 3272 NBR 70 Sh A</p>  <p>Rolo 25 m</p>	<p>IBC 3482 NBR 70 Sh A</p>  <p>Rolo 25 m</p>		

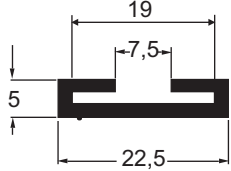
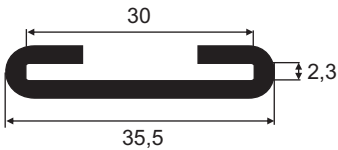
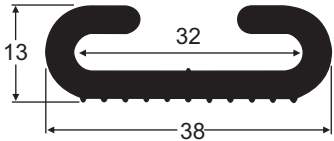
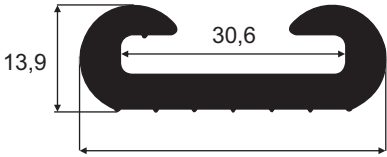
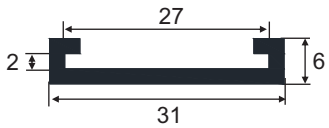
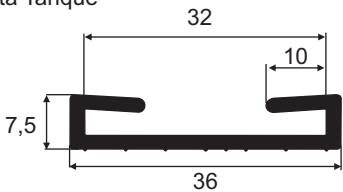
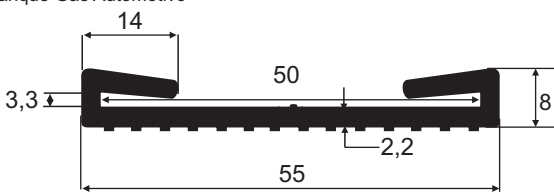
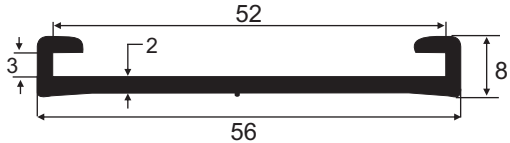
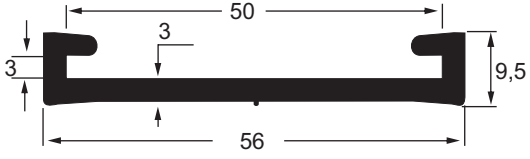
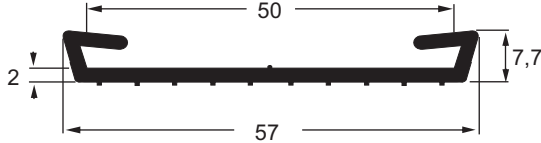
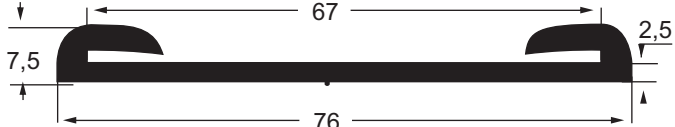
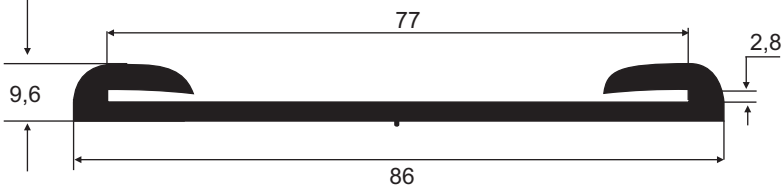

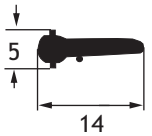
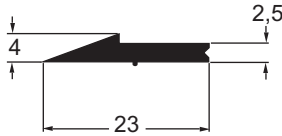
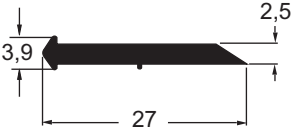
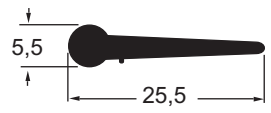
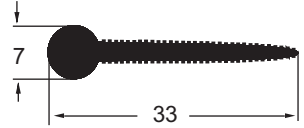
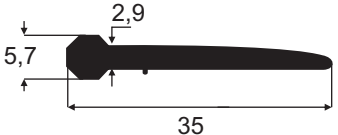
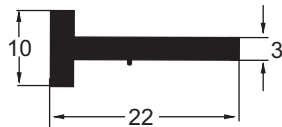
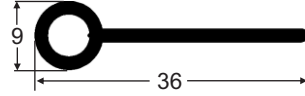
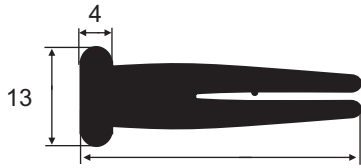
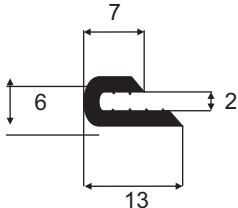
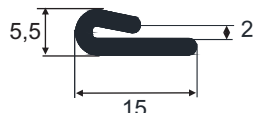
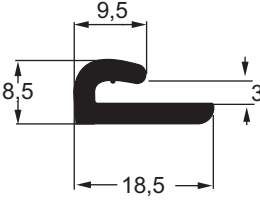
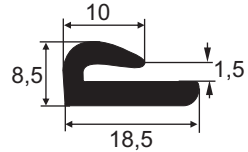
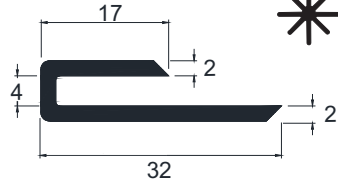
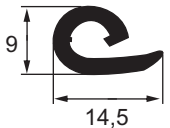

* ITEM NOVO

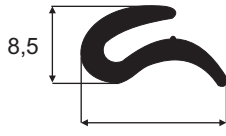
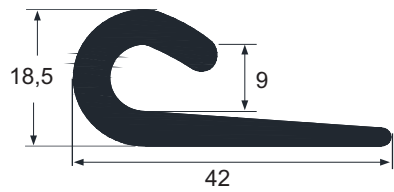
<p>IBC 3056 SBR 70 Sh A</p>  <p>Rolo 50 m</p>	<p>IBC 3520 EPDM 65 Sh A</p>  <p>Rolo 50 m</p>	<p>IBC 3392 EPDM 80 Sh A Degraus de escada para lanchas</p>  <p>Rolo 25 m</p>	<p>IBC 3291 EPDM 65 Sh A IBC 3405 EPDM 80 Sh A</p>  <p>Rolo 25 m</p>
<p>IBC 3680 EPDM 70 Sh A Cinta Tanque</p>  <p>Rolo 25 m</p>	<p>IBC 3417 SBR 7001 Sh A Cinta Tanque</p>  <p>Rolo 25 m</p>	<p>IBC 3264 SBR 60 Sh A Tanque Gás Automotivo</p>  <p>Rolo 25 m</p>	
<p>IBC 3216 NBR 70 Sh A Cinta Tanque</p>  <p>Rolo 25 m</p>	<p>IBC 3192 EPDM 65 Sh A Cinta Tanque</p>  <p>Rolo 25 m</p>	<p>IBC 3186 SBR 70 Sh A Tanque Gás Automotivo</p>  <p>Rolo 25 m</p>	
<p>IBC 3156 SBR 70 Sh A IBC 3176 EPDM 65 Sh A IBC 3271 NBR 70 Sh A</p>  <p>Rolo 25 m</p>		<p>IBC 3468 NBR 70 Sh A IBC 3502 SBR 70 Sh A</p>  <p>Rolo 25 m</p>	

* ITEM NOVO

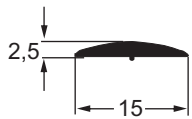
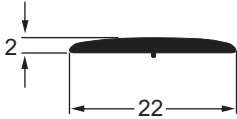
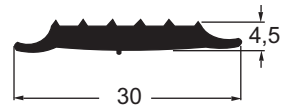
<p>IBC 3358 SBR 60 Sh A</p>  <p>Rolo 100 m</p>	<p>IBC 3039 EPDM 65 Sh A Perfil para Rodo</p>  <p>Rolo 100 m</p>	<p>IBC 3040 SBR 80 Sh A Perfil para Rodo</p>  <p>Rolo 50 m</p>	<p>IBC 3120 SBR 70 Sh A Perfil para Rodo</p>  <p>Rolo 50 m</p>	<p>IBC 3144 SBR 70 Sh A Perfil de Acabamento</p>  <p>Rolo 50 m</p>
<p>IBC 3196 SBR 80 Sh A Perfil para Rodo</p>  <p>Rolo 100 m</p>	<p>IBC 3007 SBR 70 Sh A</p>  <p>Rolo 50 m</p>	<p>IBC 3421 SBR 70 Sh A</p>  <p>Rolo 50 m</p>	<p>IBC 3422 SBR 70 Sh A</p>  <p>Rolo 25 m</p>	
<p>IBC 3213 EPDM 80 Sh A</p>  <p>Rolo 100 m</p>	<p>IBC 3622 SBR 80 Sh A</p>  <p>Rolo 100 m</p>	<p>IBC 3201 SBR 70 Sh A</p>  <p>Rolo 50 m</p>	<p>IBC 3532 EPDM 70 Sh A</p>  <p>Rolo 50 m</p>	<p>IBC 3582 EPDM 70 Sh A</p>  <p>Rolo 25m</p>
<p>IBC 3370 SBR 80 Sh A</p>  <p>Rolo 50 m</p>	<p>IBC 3367 SBR 80 Sh A</p>  <p>Rolo 50 m</p>	<p>IBC 3387 SBR 70 Sh A</p>  <p>Rolo 50 m</p>	<p>IBC 3645 SBR 70 Sh A</p>  <p>Rolo 25m</p>	

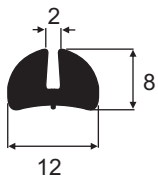
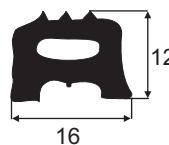
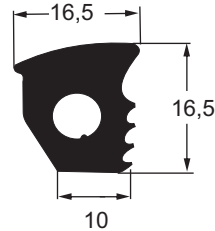
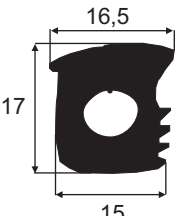
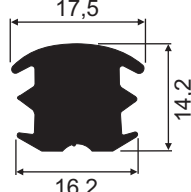
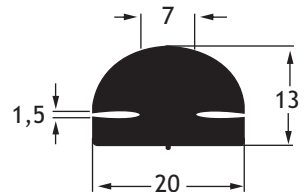
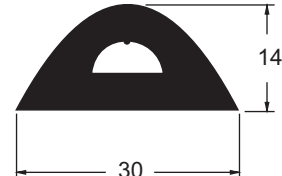
* ITEM NOVO

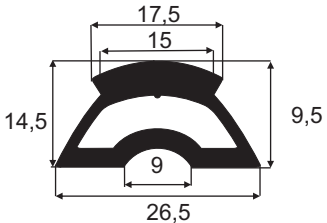
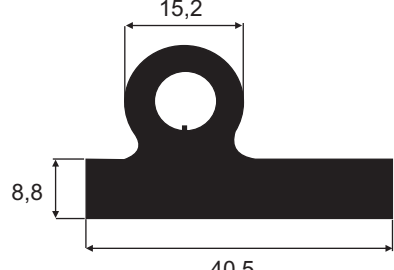
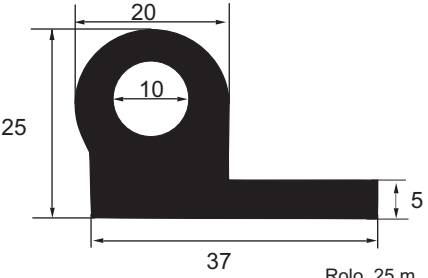
<p>IBC 3068 SBR 70 Sh A</p>  <p>Rolo 100 m</p>	<p>IBC 3193 EPDM 75 Sh A</p>  <p>Rolo 100 m</p>	<p>IBC 3087 SBR 70 Sh A</p>  <p>Rolo 50 m</p>	<p>IBC 3322 EPDM 65 Sh A</p>  <p>Rolo 50 m</p>
<p>IBC 3240 SBR 80 Sh A Friso Lateral Ônibus</p>  <p>Rolo 50 m</p>	<p>IBC 3242 SBR 70 Sh A Friso Lateral Ônibus</p>  <p>Rolo 50 m</p>	<p>IBC 3335 SBR 70 Sh A</p>  <p>Rolo 50 m</p>	<p>IBC 3361 EPDM 70 Sh A</p>  <p>Rolo 25 m</p>
<p>IBC 3351 EPDM 70 Sh A</p>  <p>Rolo 25 m</p>	<p>IBC 3443 EPDM 70 Sh A</p>  <p>Rolo 50 m</p>	<p>IBC 3185 SBR 70 Sh A</p>  <p>Rolo 25 m</p>	<p>IBC 3001 SBR 70 Sh A</p>  <p>Rolo 25 m</p>
<p>IBC 3247 SBR 60 Sh A</p>  <p>Rolo 50 m</p>	<p>IBC 3199 SBR 70 Sh A Batente Lateral Barco</p>  <p>Rolo 25 m</p>	<p>IBC 3334 EPDM 65 Sh A</p>  <p>Rolo 25 m</p>	<p>IBC 3559 NBR 65 Sh A</p>  <p>Rolo 25 m</p>

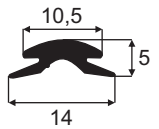
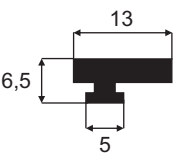
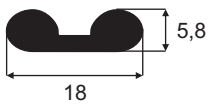
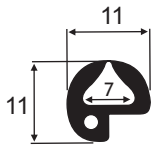
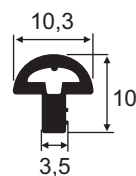
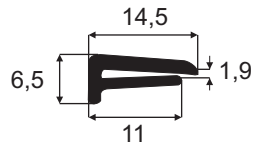
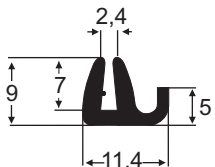
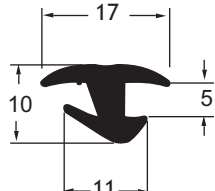
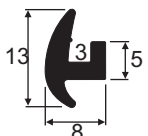
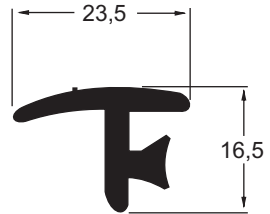
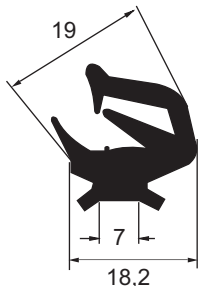
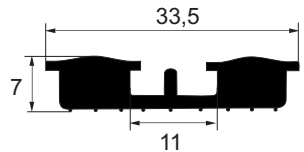
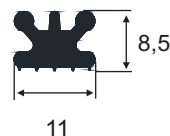
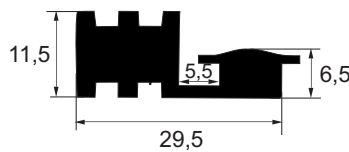
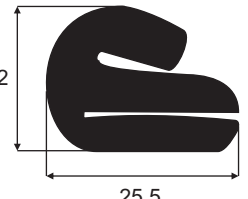
<p>IBC 3423 EPDM 75 Sh A Calha de Água</p>  <p>Rolo 100 m</p>	<p>IBC 3454 EPDM 70 Sh A</p>  <p>Rolo 100 m</p>	<p>IBC 3350 SBR 70 Sh A</p>  <p>Rolo 50 m</p>	<p>IBC 3244 SBR 80 Sh A</p>  <p>Rolo 50 m</p>	<p>IBC 3399 SBR 80 Sh A</p>  <p>Rolo 100 m</p>
<p>IBC 3506 EPDM 80 Sh A Vedação externa capacetes *</p>  <p>Rolo 100 m</p>	<p>IBC 3187 EPDM 65 Sh A</p>  <p>Rolo 50 m</p>	<p>IBC 3143 SBR 80 Sh A</p>  <p>Rolo 50 m</p>	<p>IBC 3397 EPDM 75 Sh A</p>  <p>Rolo 50 m</p>	<p>IBC 3129 SBR 70 Sh A</p>  <p>Rolo 25 m</p>
<p>IBC 3081 SBR 70 Sh A</p>  <p>Rolo 25 m</p>	<p>IBC 3556 EPDM 75 Sh A *</p>  <p>Rolo 25 m</p>	<p>IBC 3575 NBR 85 Sh A *</p>  <p>Rolo 50 m</p>	<p>IBC 3557 EPDM 80 Sh A *</p>  <p>Rolo 25 m</p>	<p>IBC 3357 SBR 80 Sh A</p>  <p>Rolo 25m</p>

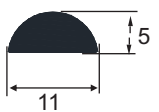
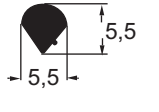
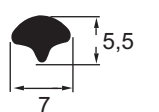
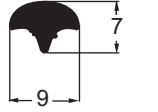
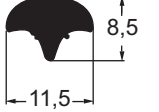
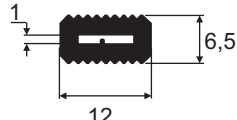
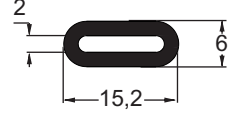
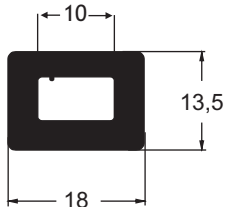
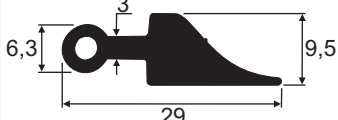
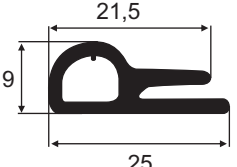
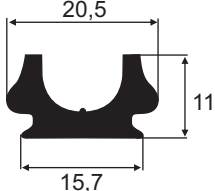
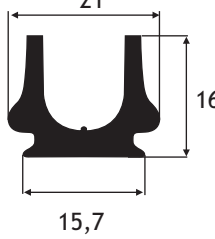
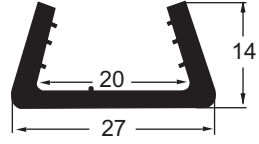
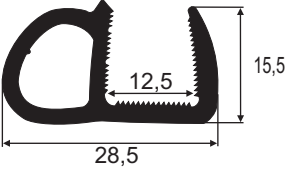
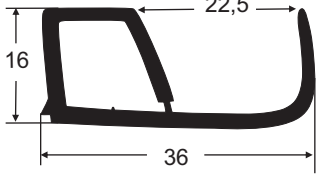

* ITEM NOVO

<p>IBC 3598 EPDM 80 Sh A</p>  <p>Rolo 100 m</p>	<p>IBC 3103 SBR 70 Sh A Cunha</p>  <p>Rolo 100 m</p>	<p>IBC 3102 SBR 70 Sh A IBC 3314 NBR 70 Sh A IBC 3460 EPDM 70 Sh A</p>  <p>Rolo 50 m</p>	<p>IBC 3101 SBR 70 Sh A IBC 3426 EPDM 70 Sh A IBC 3427 NBR 70 Sh A Cunha</p>  <p>Rolo 50 m</p>	<p>IBC 3119 SBR 70 Sh A Cunha</p>  <p>Rolo 50 m</p>
<p>IBC 3075 SBR 70 Sh A</p>  <p>Rolo 100 m</p>	<p>IBC 3315 SBR 70 Sh A</p>  <p>Rolo 50 m</p>	<p>IBC 3086 SBR 70 Sh A</p>  <p>Rolo 25 m</p>	<p>IBC 3446 EPDM 70 Sh A</p>  <p>Rolo 25 m</p>	<p>IBC 3253 SBR 70 Sh A Vedação Balcão Frigorífico</p>  <p>Rolo 25 m</p>
<p>IBC 3239 SBR 80 Sh A Friso Acabam. Poltronas Ônibus</p>  <p>Rolo 25 m</p>	<p>IBC 3234 SBR 80 Sh A Friso Acabam. Poltronas Ônibus</p>  <p>Rolo 25 m</p>	<p>IBC 3009 SBR 70 Sh A</p>  <p>Rolo 25 m</p>	<p>IBC 3424 EPDM 75 Sh A</p>  <p>Rolo 25 m</p>	<p>IBC 3553 EPDM 75 Sh A</p>  <p>Rolo 25 m</p>

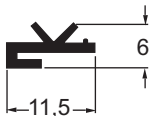
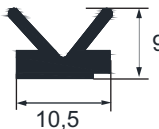
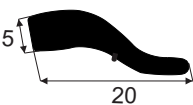
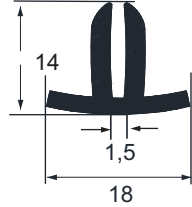
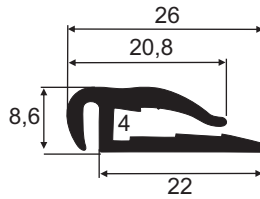
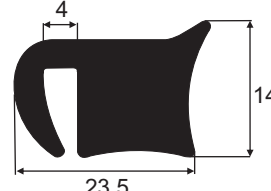
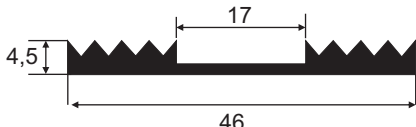
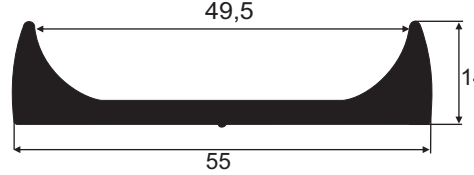
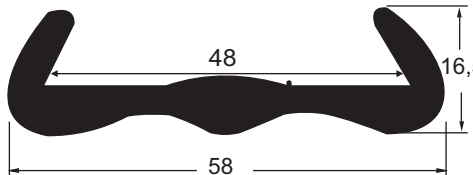
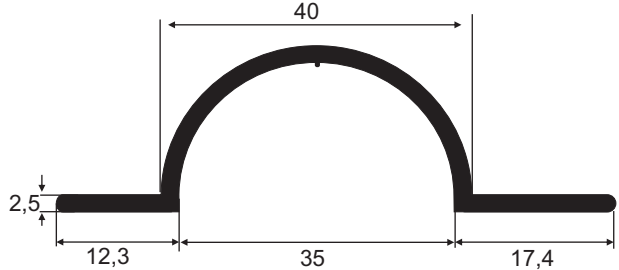
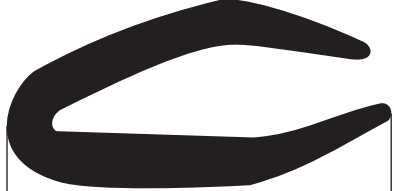
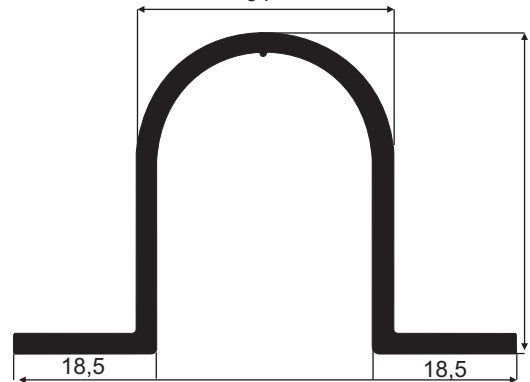

* ITEM NOVO

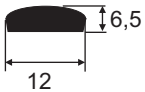
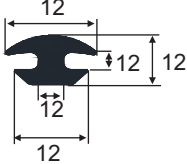
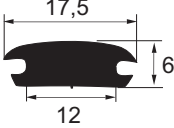
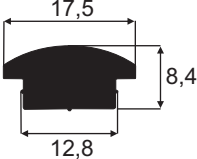
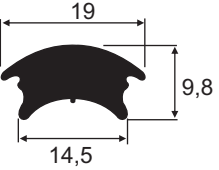
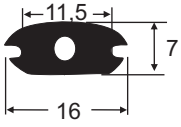
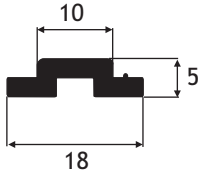
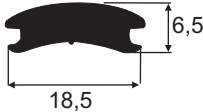
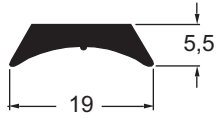
<p>IBC 3090 EPDM 65 Sh A</p>  <p>Rolo 100 m</p>	<p>IBC 3075 SBR 70 Sh A</p>  <p>Rolo 50 m</p>	<p>IBC 3311 EPDM 75 Sh A Protetor Tapapó Ônibus Articulado</p>  <p>Rolo 50 m</p>	<p>IBC 3640 EPDM 80 Sh A</p>  <p>Rolo 50 m</p>	<p>IBC 3433 EPDM 75 Sh A</p>  <p>Rolo 50 m</p>
<p>IBC 3467 EPDM 75 Sh A</p>  <p>Rolo 25m</p>	<p>IBC 3469 EPDM 70 Sh A</p>  <p>Rolo 25m</p>	<p>IBC 3447 SBR 70 Sh A</p>  <p>Rolo 25 m</p>	<p>IBC 3063 SBR 70 Sh A</p>  <p>Rolo 25 m</p>	
<p>IBC 3265 SBR 80 Sh A</p>  <p>Rolo 25 m</p>		<p>IBC 3479 EPDM 75 Sh A</p>  <p>Rolo 25 m</p>	<p>IBC 3431 EPDM 70 Sh A</p>  <p>Rolo 25 m</p>	

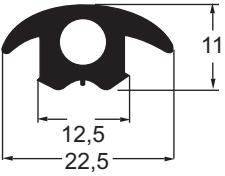
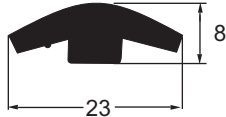
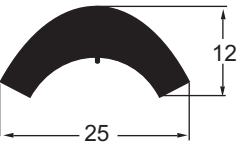
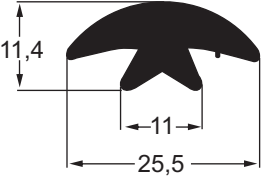
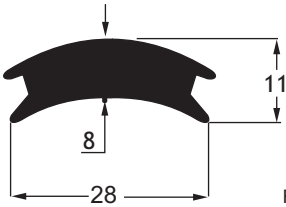
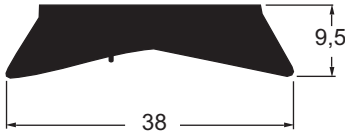



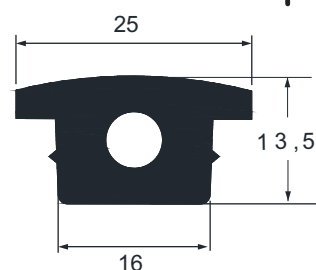
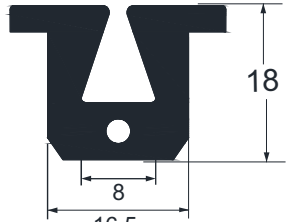
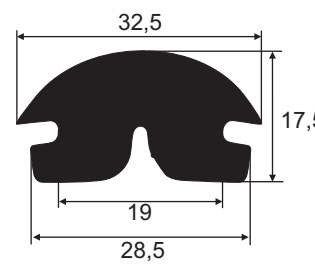
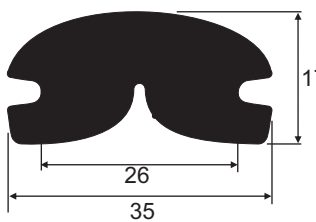
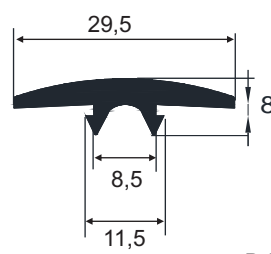
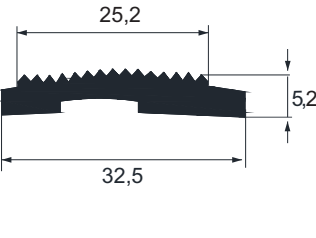
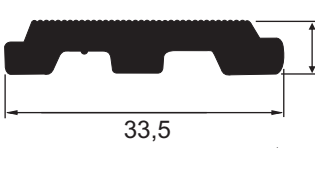
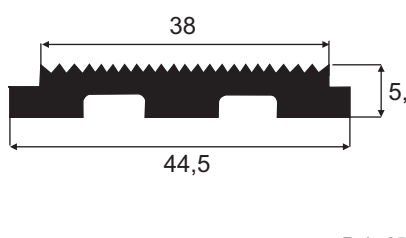
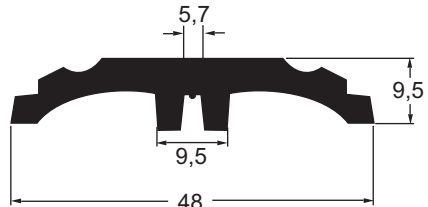

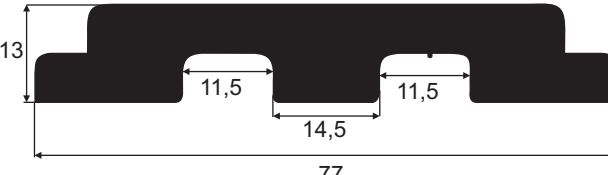
* ITEM NOVO

<p>IBC 3075 SBR 70 Sh A</p>  <p>Rolo 50 m</p>	<p>IBC 3075 SBR 70 Sh A</p>  <p>Rolo 50 m</p>	<p>IBC 3561 EPDM 75 Sh A</p>  <p>Rolo 50 m</p>	<p>IBC 3435 EPDM 75 Sh A</p>  <p>Rolo 50 m</p>
<p>IBC 3238 SBR 80 Sh A Batente Lateral Ônibus</p>  <p>Rolo 50 m</p>	<p>IBC 3552 EPDM 75 Sh</p>  <p>Rolo 50 m</p>	<p>IBC 3237 SBR 80 Sh A</p>  <p>Rolo 50 m</p>	<p>IBC 3448 EPDM 75 Sh A</p>  <p>Rolo 50 m</p>
<p>IBC 3070 SBR 70 Sh A Friso Lateral Ônibus</p>  <p>Rolo 50 m</p>	<p>IBC 3075 SBR 70 Sh A</p>  <p>Rolo 50 m</p>	<p>IBC 3072 SBR 80 Sh A</p>  <p>Rolo 50 m</p>	<p>IBC 3371 SBR 70 Sh A</p>  <p>Rolo 50 m</p>
<p>IBC 3161 SBR 80 Sh A Batente Lateral Barcos</p>  <p>Rolo 25 m</p>	<p>IBC 3206 SBR 80 Sh A</p>  <p>Rolo 25 m</p>	<p>IBC 3202 SBR 80 Sh A Batente Lateral Ônibus</p>  <p>Rolo 25 m</p>	<p>IBC 3069 SBR 70 Sh A Friso Lateral Ônibus</p>  <p>Rolo 25 m</p>

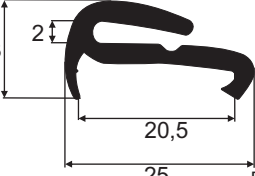
 ITEM NOVO

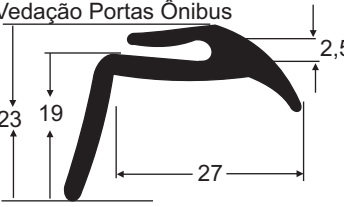
<p>IBC 3630 SBR 80 Sh A *</p>  <p>25 13,5 16</p> <p>Rolo 25 m</p>	<p>IBC 3631 SBR 80 Sh A *</p>  <p>18 8 16,5</p> <p>Rolo 25 m</p>	<p>IBC 3544 EPDM 65 Sh A</p>  <p>32,5 17,5 19 28,5</p> <p>Rolo 25 m</p>	<p>IBC 3442 EPDM 75 Sh A</p>  <p>17,5 26 35</p> <p>Rolo 25 m</p>
<p>IBC 3594 EPDM 80 Sh A *</p>  <p>29,5 8 8,5 11,5</p> <p>Rolo 25 m</p>	<p>IBC 3613 EPDM 80 Sh A *</p>  <p>25,2 5,2 32,5</p> <p>Rolo 50 m</p>	<p>IBC 3384 SBR 70 Sh A</p>  <p>6 33,5</p> <p>Rolo 50 m</p>	<p>IBC 3512 SBR 85 Sh A IBC 3518 EPDM 80 Sh A</p>  <p>38 5,3 44,5</p> <p>Rolo 25 m</p>
<p>IBC 3071 SBR 80 Sh A Friso Lateral Ônibus</p>  <p>5,7 9,5 48</p> <p>Rolo 25 m</p>	<p>IBC 3231 SBR 70 Sh A Batente Lateral Ônibus</p>  <p>6,5 66</p> <p>Rolo 25 m</p>	<p>IBC 3226 EPDM 80 Sh A</p>  <p>13 11,5 14,5 11,5 77</p> <p>Rolo 25 m</p>	

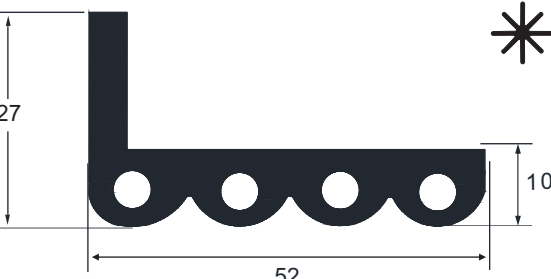
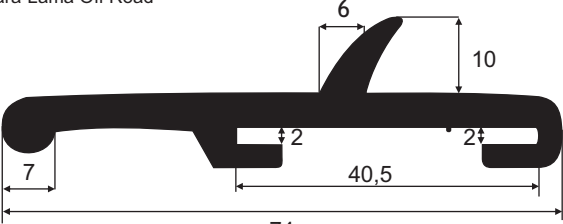
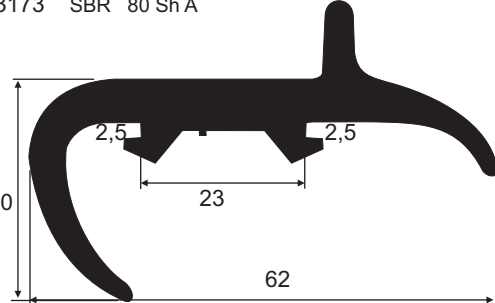
* ITEM NOVO

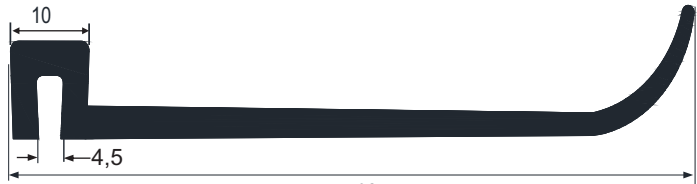
<p>IBC 3261 SBR 80 Sh A</p>  <p>Rolo 50 m</p>	<p>IBC 3462 EPDM 75 Sh A</p>  <p>Rolo 25 m</p>	<p>IBC 3620 EPDM 75 Sh A *</p>  <p>Rolo 50 m</p>	<p>IBC 3052 SBR 80 Sh A</p>  <p>Rolo 25 m</p>	<p>IBC 3084 SBR 70 Sh A Vedação Portas Ônibus</p>  <p>Rolo 25 m</p>
<p>IBC 3224 EPDM 70 Sh A IBC 3411 SBR 70 Sh A Vedação Portabras</p>  <p>Rolo 25 m</p>	<p>IBC 3172 EPDM 75 Sh A</p>  <p>Rolo 25 m</p>	<p>IBC 3628 EPDM 65 Sh A *</p>  <p>Rolo 25 m</p>		
<p>IBC 3220 EPDM 80 Sh A Pára-Lama Off Road</p>  <p>Rolo 25 m</p>	<p>IBC 3173 SBR 80 Sh A</p>  <p>Rolo 25 m</p>	<p>IBC 3601 EPDM 75 Sh A *</p>  <p>Rolo 25 m</p>		
<p>IBC 3617 EPDM 80 Sh A *</p>  <p>Rolo 25 m</p>	<p>IBC 3581 EPDM 75 Sh A *</p>  <p>Rolo 25 m</p>			

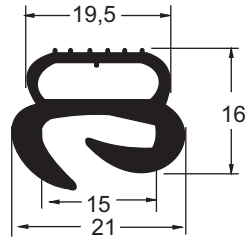
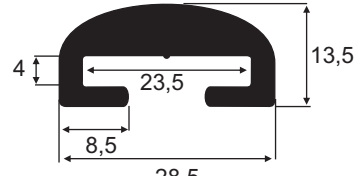
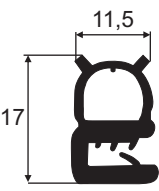
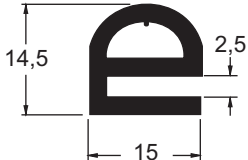
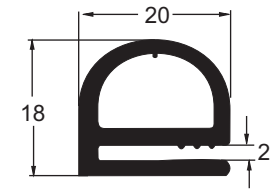
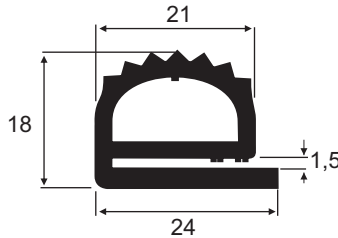
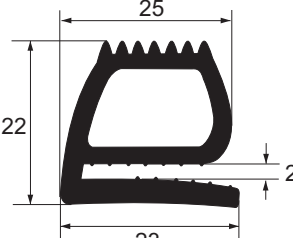
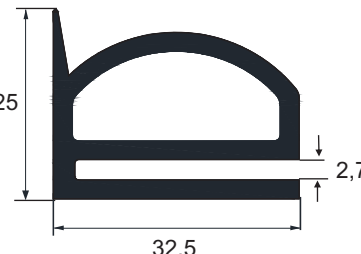
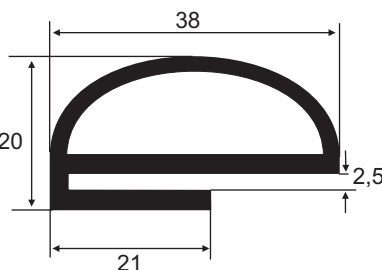
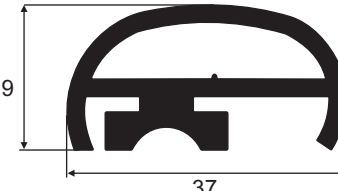
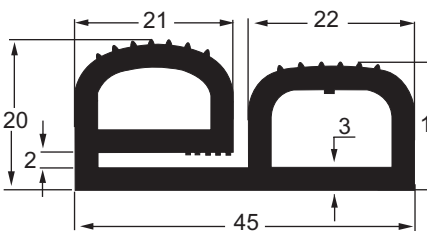
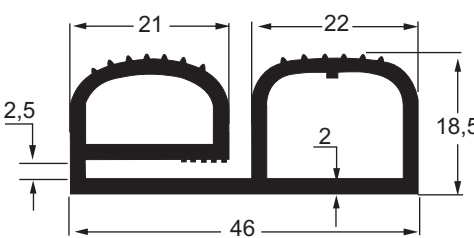
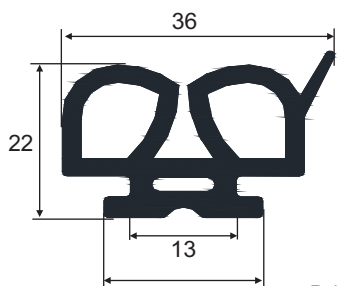

* ITEM NOVO

<p>IBC 3008 EPDM 75 Sh A</p>  <p>Rolo 25 m</p>	<p>IBC 3228 EPDM 75 Sh A Batente Lateral Balcao Frigorifico</p>  <p>Rolo 25 m</p>	<p>IBC 3195 EPDM 65 Sh A</p>  <p>Rolo 25 m</p>	<p>IBC 3064 SBR 70 Sh A</p>  <p>Rolo 50 m</p>	<p>IBC 3036 SBR 70 Sh A IBC 3225 EPDM 70 Sh A</p>  <p>Rolo 25 m</p>
<p>IBC 3132 SBR 70 Sh A</p>  <p>Rolo 25 m</p>	<p>IBC 3249 EPDM 70 Sh A</p>  <p>Rolo 25 m</p>	<p>IBC 3655 EPDM 70 Sh A</p>  <p>Rolo 25 m</p>	<p>IBC 3214 SBR 80 Sh A</p>  <p>Rolo 25 m</p>	
<p>IBC 3318 SBR 70 Sh A</p>  <p>Rolo 25 m</p>	<p>IBC 3190 SBR 70 Sh A Vedação Porta Furgão</p>  <p>Rolo 25 m</p>	<p>IBC 3183 SBR 80 Sh A IBC 3416 EPDM 80 Sh A Vedação Porta Furgão</p>  <p>Rolo 25 m</p>	<p>IBC 3674 EPDM 70 Sh A</p>  <p>Rolo 25 m</p>	

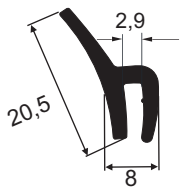
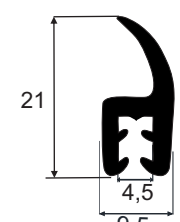
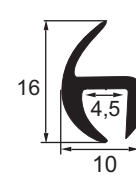
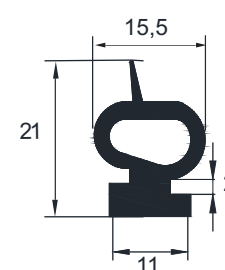
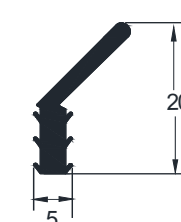
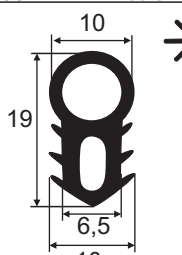
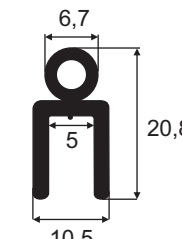
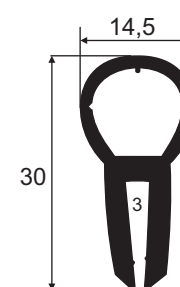
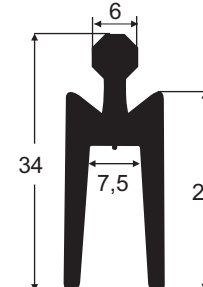
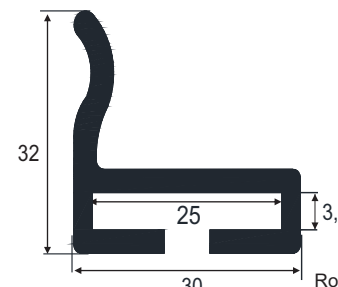
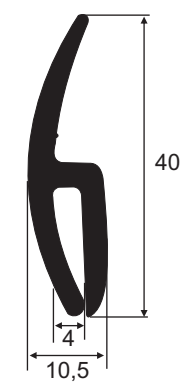
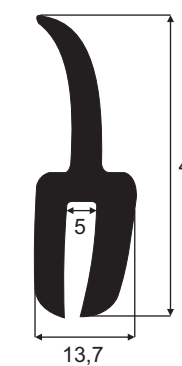
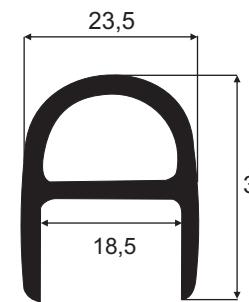
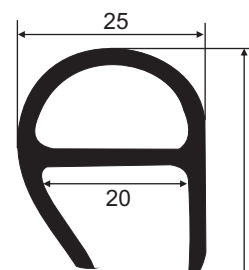
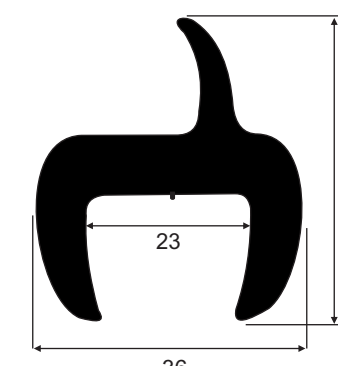

* ITEM NOVO

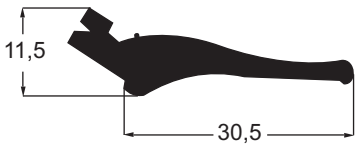
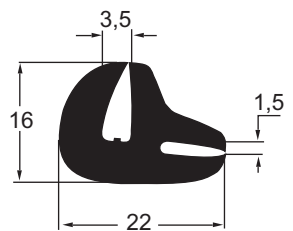
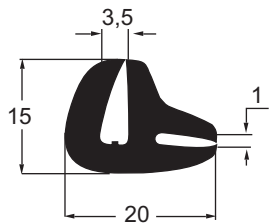
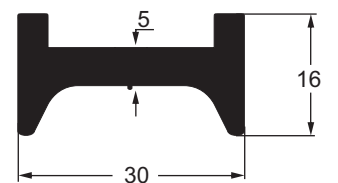
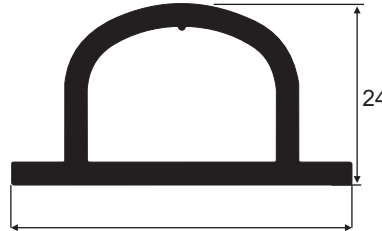
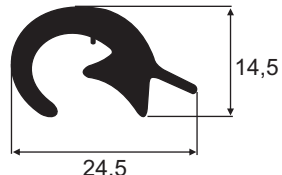
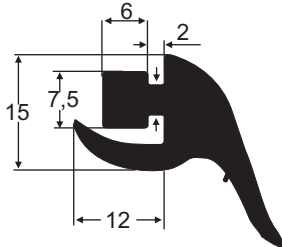
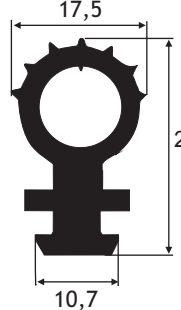
<p>IBC 3428 EPDM 70 Sh A</p>  <p>Rolo 50 m</p>	<p>IBC 3570 EPDM 80 Sh A *</p>  <p>Rolo 50 m</p>	<p>IBC 3562 EPDM 75 Sh A *</p>  <p>Rolo 50 m</p>	<p>IBC 3573 EPDM 65 Sh A *</p>  <p>Rolo 25 m</p>	<p>IBC 3627 NBR 80 Sh A *</p>  <p>Rolo 50 m</p>
<p>IBC 3510 EPDM 70 Sh A IBC 3658 EPDM 60 Sh A *</p>  <p>Rolo 50 m</p>	<p>IBC 3251 SBR 70 Sh A Vedação Balcao Frigorífico</p>  <p>Rolo 25 m</p>	<p>IBC 3221 EPDM 80 Sh A</p>  <p>Rolo 25 m</p>	<p>IBC 3198 SBR 80 Sh A Perfil Rodo</p>  <p>Rolo 25 m</p>	<p>IBC 3669 EPDM 75 Sh A *</p>  <p>Rolo 25 m</p>
<p>IBC 3408 EPDM 65 Sh A</p>  <p>Rolo 25 m</p>	<p>IBC 3273 SBR 80 Sh A</p>  <p>Rolo 25 m</p>	<p>IBC 3519 EPDM 70 Sh A Vedação portas Portabrás</p>  <p>Rolo 25 m</p>	<p>IBC 3533 EPDM 75 Sh A Vedação porta Furgão</p>  <p>Rolo 25 m</p>	<p>IBC 3259 EPDM 70 Sh A</p>  <p>Rolo 25 m</p>

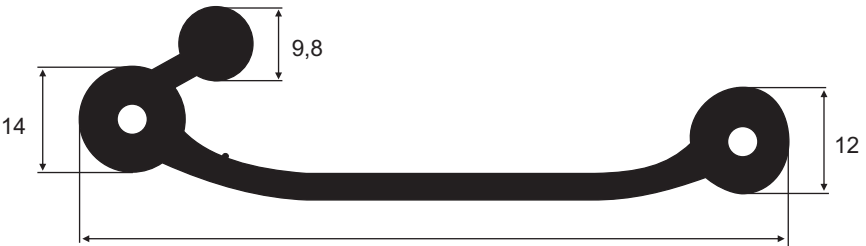
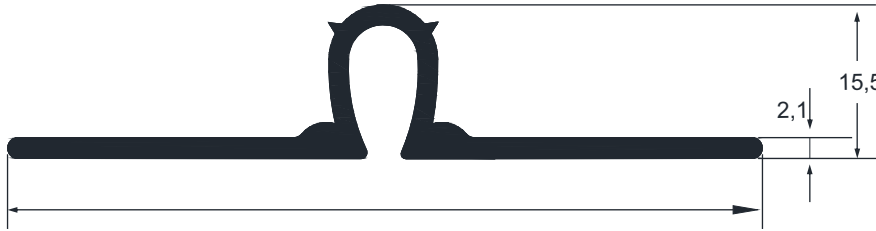
* ITEM NOVO

<p>IBC 3080 SBR 70 Sh A</p>  <p>Rolo 50 m</p>	<p>IBC 3149 SBR 70 Sh A</p>  <p>Rolo 25 m</p>	<p>IBC 3154 SBR 70 Sh A</p>  <p>Rolo 25 m</p>	<p>IBC 3191 EPDM 65 Sh A Vedação Portas de Baú Portabráis</p>  <p>Rolo 25 m</p>	<p>IBC 3464 EPDM 75 Sh A</p>  <p>Rolo 25 m</p>
<p>IBC 3235 SBR 80 Sh A Vedação Vidros Ônibus</p>  <p>Rolo 25 m</p>	<p>IBC 3145 EPDM 75 Sh A</p>  <p>Rolo 50 m</p>	<p>IBC 3354 SBR 80 Sh A</p>  <p>Rolo 25 m</p>	<p>IBC 3480 EPDM 70 Sh A Vedação câmara fria Estacionária</p>  <p>Rolo 25 m</p> <p style="text-align: right;">*</p>	
<p>IBC 3359 EPDM 65 Sh A</p>  <p>Rolo 15m</p>		<p>IBC 3619 EPDM 65 Sh A</p>  <p>Rolo 25 m</p> <p style="text-align: right;">*</p>		

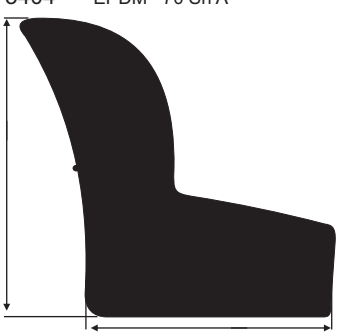

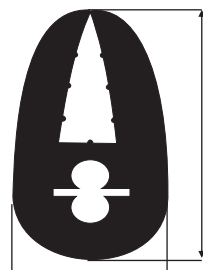
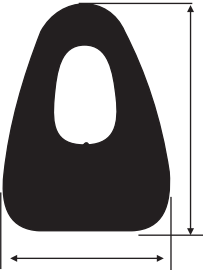
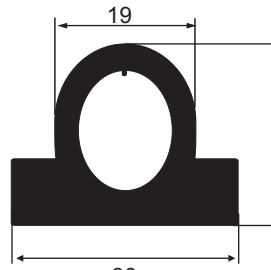
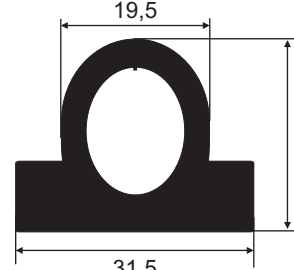
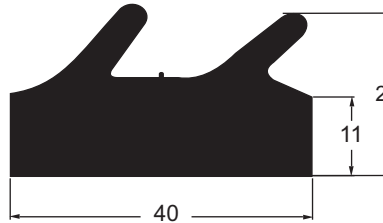
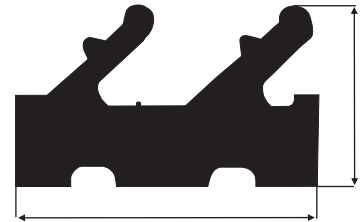
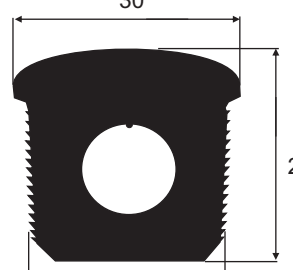
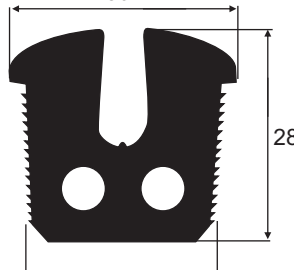
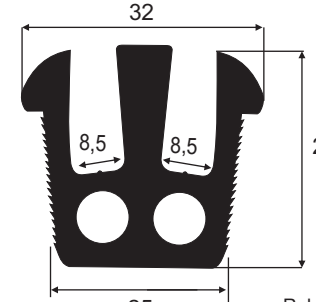
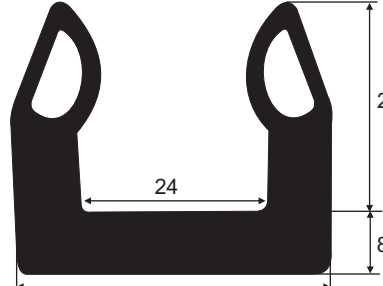
* ITEM NOVO

<p>IBC 3404 EPDM 70 Sh A</p>  <p>39,5</p> <p>32</p> <p>Rolo 25 m</p>	<p>IBC 3456 EPDM 70 Sh A</p>  <p>36</p> <p>55</p> <p>35</p> <p>Rolo 25 m</p>	<p>IBC 3470 EPDM 70 Sh A</p>  <p>33</p> <p>20,5</p> <p>Rolo 25 m</p>	<p>IBC 3400 NBR 70 Sh A</p>  <p>30</p> <p>22</p> <p>Rolo 25 m</p>
<p>IBC 3287 EPDM 65 Sh A Vedação Fulão</p>  <p>19</p> <p>24</p> <p>30</p> <p>Rolo 25 m</p>	<p>IBC 3540 NBR 70 Sh A Vedação Fulão</p>  <p>19,5</p> <p>25</p> <p>31,5</p> <p>Rolo 25 m</p>	<p>IBC 3117 EPDM 65 Sh A Vedação Fulão</p>  <p>22</p> <p>11</p> <p>40</p> <p>Rolo 25 m</p>	<p>IBC 3290 EPDM 65 Sh A Vedação Fulão</p>  <p>24</p> <p>39</p> <p>Rolo 25 m</p>
<p>IBC 3385 EPDM 75 Sh A</p>  <p>30</p> <p>28</p> <p>26,5</p> <p>Rolo 25 m</p>	<p>IBC 3386 EPDM 75 Sh A</p>  <p>30</p> <p>28</p> <p>25</p> <p>Rolo 25 m</p>	<p>IBC 3478 EPDM 75 Sh A</p>  <p>32</p> <p>29,5</p> <p>8,5</p> <p>8,5</p> <p>25</p> <p>Rolo 25 m</p>	<p>IBC 3495 EPDM 65 Sh A</p>  <p>28</p> <p>24</p> <p>42,5</p> <p>8</p> <p>Rolo 25 m</p>

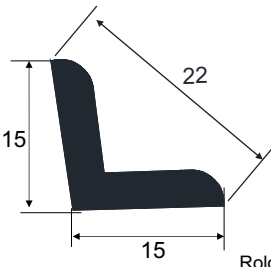
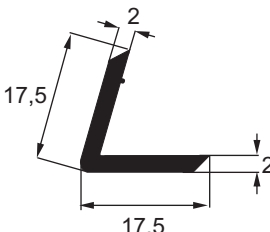
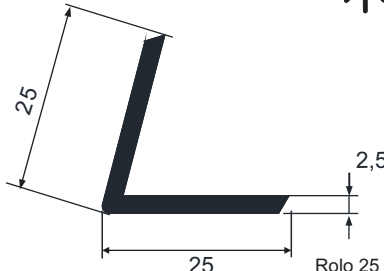
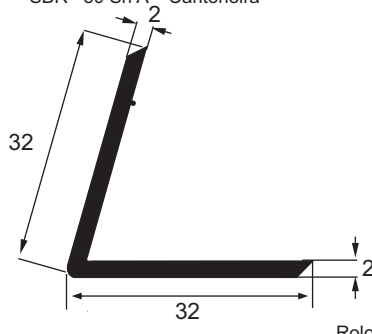
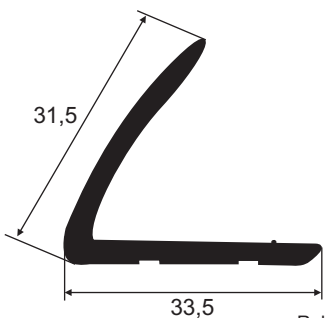
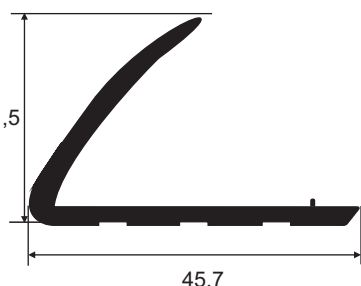
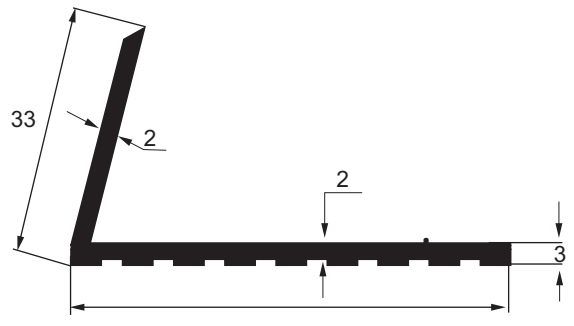
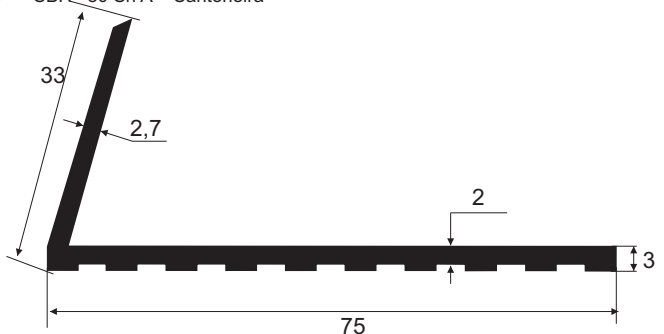
* ITEM NOVO

<p>IBC 3608 EPDM 70 Sh A *</p>  <p>Rolo 50 m</p>	<p>IBC 3209 SBR 80 Sh A Cantoneira</p>  <p>Rolo 50 m</p>	<p>IBC 3604 SBR 85 Sh A Cantoneira *</p>  <p>Rolo 25 m</p>	<p>IBC 3210 SBR 80 Sh A Cantoneira</p>  <p>Rolo 25 m</p>
<p>IBC 3227 SBR 80 Sh A Cantoneira</p>  <p>Rolo 25 m</p>	<p>IBC 3229 SBR 80 Sh A Cantoneira</p>  <p>Rolo 25 m</p>	<p>IBC 3211 SBR 80 Sh A Cantoneira</p>  <p>Rolo 25 m</p>	
<p>IBC 3543 SBR 80 Sh A Cantoneira *</p>  <p>Rolo 25 m</p>			

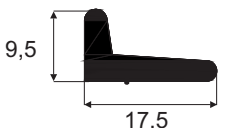
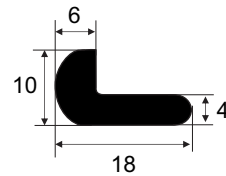
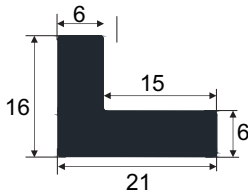
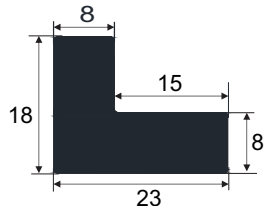
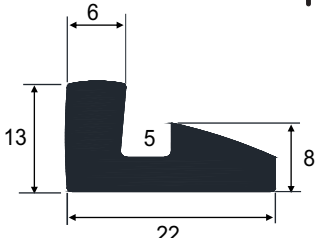
* ITEM NOVO

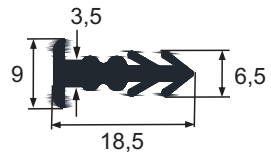
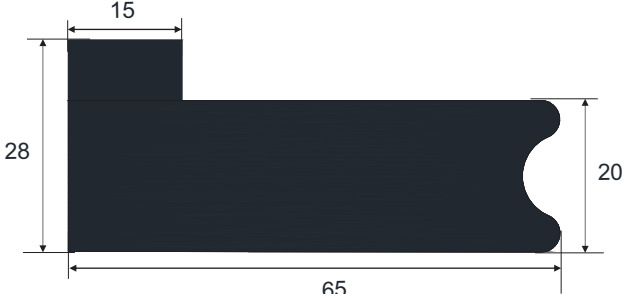
<p>IBC 3332 EPDM 65 Sh A</p>  <p>Rolo 50 m</p>	<p>IBC 3567 EPDM 70 Sh A</p>  <p>Rolo 50 m</p>	<p>IBC 3649 NBR 75 Sh A</p>  <p>Rolo 25 m</p>	<p>IBC 3648 NBR 75 Sh A</p>  <p>Rolo 25 m</p>
<p>IBC 3587 EPDM 80 Sh A</p>  <p>Rolo 25 m</p>	<p>IBC 3568 EPDM 70 Sh A</p>  <p>Rolo 50 m</p>	<p>IBC 3660 SBR 80 Sh A</p>  <p>Rolo 25 m</p>	<p>IBC 3676 EPDM 70 Sh A</p>  <p>Rolo 50 m</p>
<p>IBC 3654 NBR 70 Sh A</p>  <p>Rolo 22 m</p>			

* ITEM NOVO

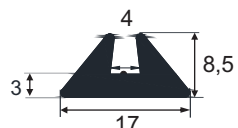
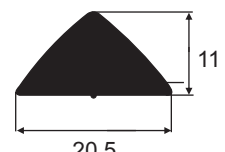
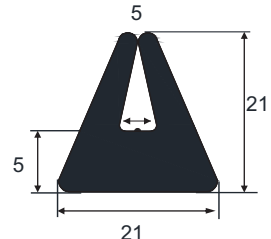
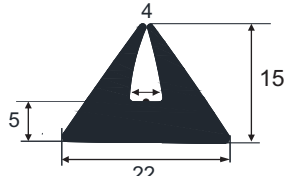
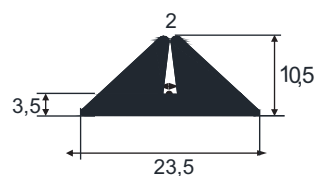
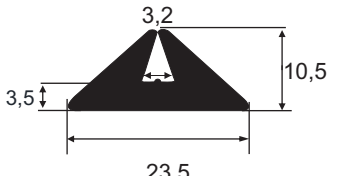
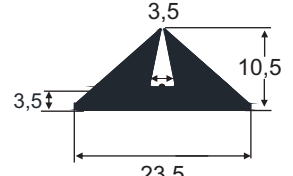
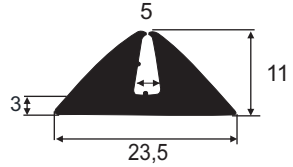
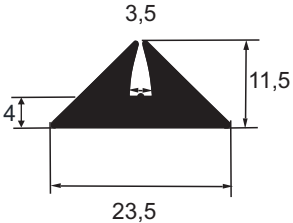
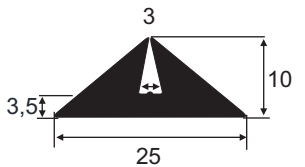
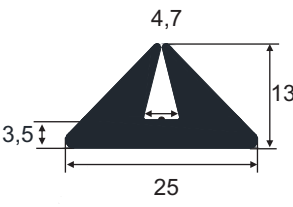
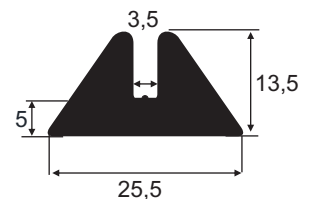
<p>IBC 3657 NBR 80 Sh A Ved. Formas Pré- Moldados</p>  <p>Rolo 50 m</p>	<p>IBC 3381 NBR 70 Sh A Ved. Formas Pré- Moldados</p>  <p>Rolo 50 m</p>	<p>IBC 3668 NBR 80 Sh A Ved. Formas Pré- Moldados</p>  <p>Rolo 25 m</p>	<p>IBC 3614 NBR 85 Sh A Ved. Formas Pré- Moldados</p>  <p>Rolo 50 m</p>
<p>IBC 3629 NBR 75 Sh A Ved. Formas Pré- Moldados</p>  <p>Rolo 50 m</p>	<p>IBC 3407 NBR 85 Sh A Ved. Formas Pré- Moldados</p>  <p>Rolo 50 m</p>	<p>IBC 3378 NBR 70 Sh A Ved. Formas Pré- Moldados</p>  <p>Rolo 50 m</p>	<p>IBC 3283 NBR 70 Sh A Ved. Formas Pré- Moldados</p>  <p>Rolo 50 m</p>
<p>IBC 3662 NBR 85 Sh A Ved. Formas Pré- Moldados</p>  <p>Rolo 50 m</p>	<p>IBC 3527 NBR 75 Sh A Ved. Formas Pré- Moldados</p>  <p>Rolo 50 m</p>	<p>IBC 3646 NBR 85 Sh A Ved. Formas Pré- Moldados</p>  <p>Rolo 50 m</p>	<p>IBC 3260 SBR 80 Sh A Ved. Formas Pré- Moldados</p>  <p>Rolo 50 m</p>

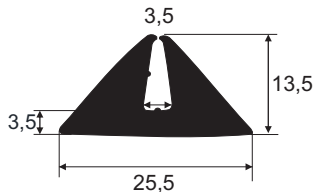
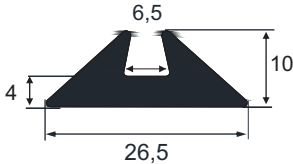
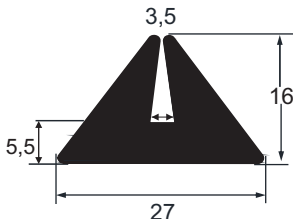
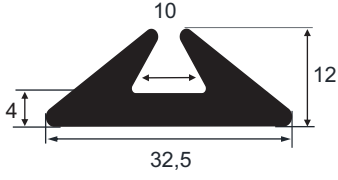
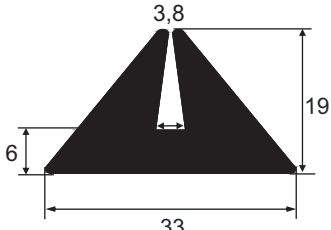
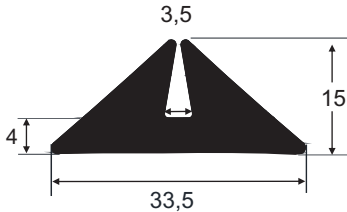
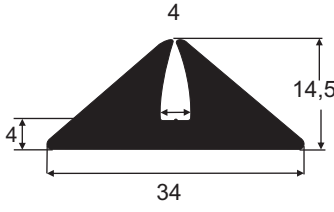
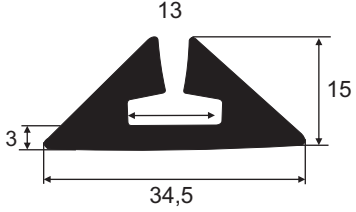
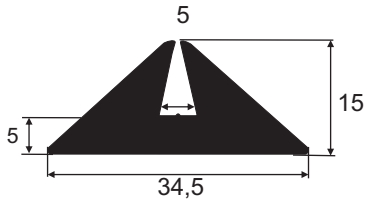
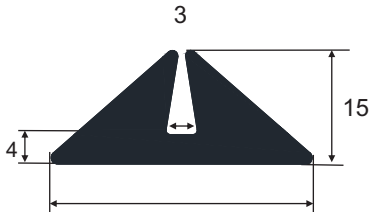
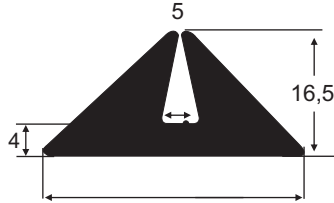
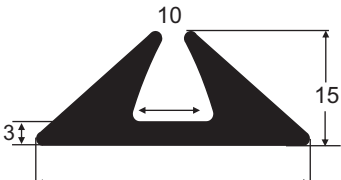

* ITEM NOVO

<p>IBC 3534 NBR 85 Sh A Ved. Formas Pré- Moldados</p>  <p>Rolo 50 m</p>	<p>IBC 3664 NBR 80 Sh A Ved. Formas Pré- Moldados</p>  <p>Rolo 100 m</p>	<p>IBC 3603. NBR 75 Sh A Ved. Formas Pré- Moldados</p>  <p>Rolo 25 m</p>	<p>IBC 3588 NBR 80 Sh A Ved. Formas Pré- Moldados</p>  <p>Rolo 25 m</p>
<p>IBC 3602 NBR 75 Sh A Ved. Formas Pré- Moldados</p>  <p>Rolo 25 m</p>	<p>IBC 3591 SBR 80 Sh A Ved. Formas Pré- Moldados</p>  <p>Rolo 25 m</p>	<p>IBC 3494 NBR 80 Sh A Ved. Formas Pré- Moldados</p>  <p>Rolo 25 m</p>	<p>IBC 3474 NBR 75 Sh A Ved. Formas Pré- Moldados</p>  <p>Rolo 25 m</p>
<p>IBC 3455 NBR 80 Sh A Ved. Formas Pré- Moldados</p>  <p>Rolo 25 m</p>	<p>IBC 3585 NBR 80 Sh A Ved. Formas Pré- Moldados</p>  <p>Rolo 25 m</p>	<p>IBC 3373 NBR 70 Sh A Ved. Formas Pré- Moldados</p>  <p>Rolo 25 m</p>	<p>IBC 3597 NBR 80 Sh A</p>  <p>Rolo 25 m</p>

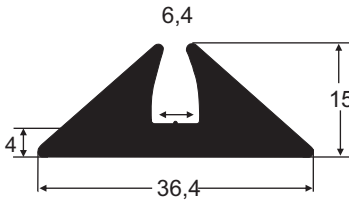
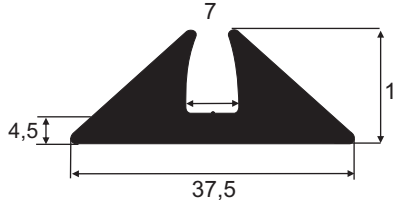
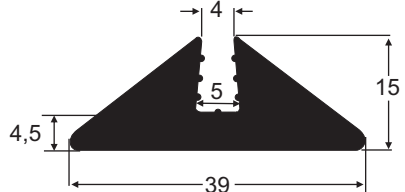
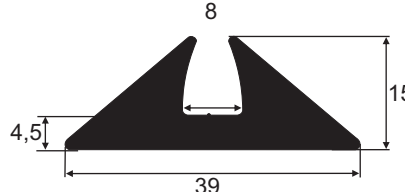
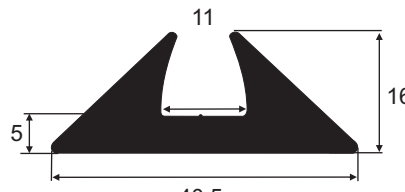
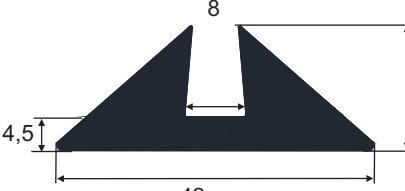
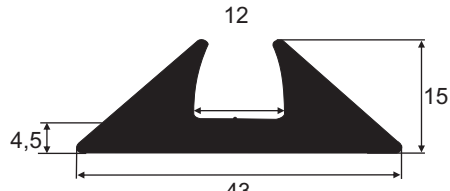
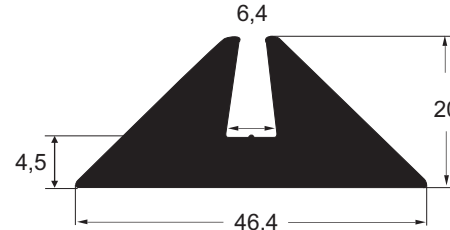
* ITEM NOVO

<p>IBC 3410 NBR 85 Sh A Ved. Formas Pré- Moldados</p>  <p>Rolo 25 m</p>	<p>IBC 3493 NBR 80 Sh A Ved. Formas Pré- Moldados</p>  <p>Rolo 25 m</p>	<p>IBC 3406 SBR 80 Sh A Vedação formas IBC 3546 NBR 75 Sh A Pré - Moldados</p>  <p>Rolo 25 m</p>
<p>IBC 3449 NBR 85 Sh A IBC 3659 NBR 65 Sh A Ved. Formas Pré- Moldados</p>  <p>Rolo 25 m</p>	<p>IBC 3492 NBR 80 Sh A Ved. Formas Pré- Moldados</p>  <p>Rolo 25 m</p>	<p>IBC 3605 NBR 80 Sh A Ved. Formas Pré- Moldados</p>  <p>Rolo 25 m</p>
<p>IBC 3488 NBR 85 Sh A Ved. Formas Pré- Moldados</p>  <p>Rolo 25 m</p>	<p>IBC 3548 NBR 80 Sh A Ved. Formas Pré- Moldados</p>  <p>Rolo 25 m</p>	

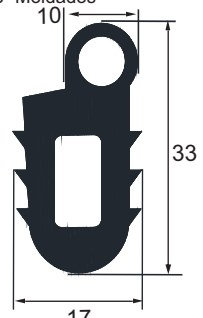

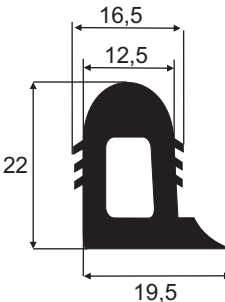
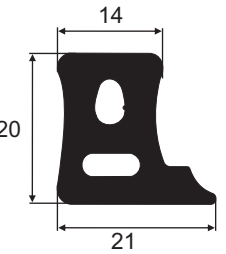
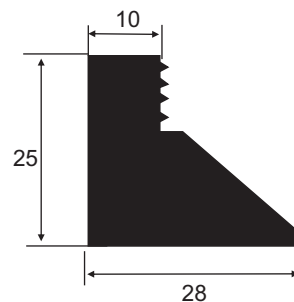
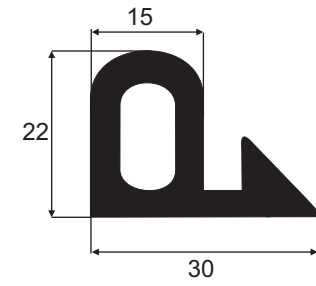
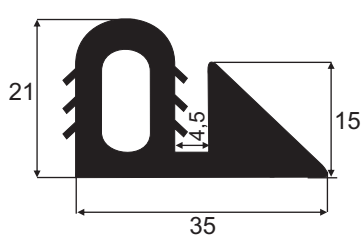
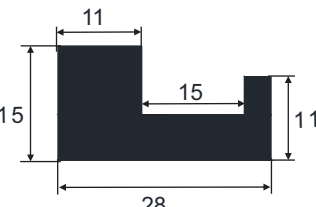
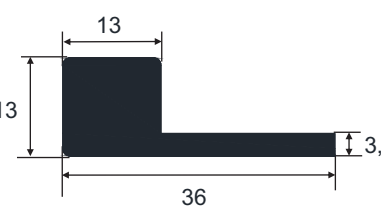
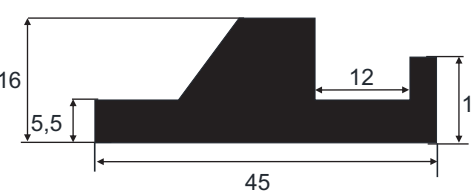
* ITEM NOVO

<p>IBC 3653 NBR 65 Sh A Ved. Formas Pré- Moldados</p>  <p>10, 33, 17</p> <p>Rolo 25 m</p> <p>*</p>	<p>IBC 3398 NBR 55 Sh A Vedação Forma Pré-Moldados</p>  <p>15,5, 26,5, 14,5</p> <p>Rolo 25 m</p>	<p>IBC 3491 NBR 80 Sh A Ved. Formas Pré- Moldados</p>  <p>16,5, 12,5, 22, 19,5</p> <p>Rolo 25 m</p>	<p>IBC 3437 NBR 55 Sh A Ved. Formas Pré- Moldados</p>  <p>14, 20, 21</p> <p>Rolo 25 m</p>
<p>IBC 3599 NBR 75 Sh A Ved. Formas Pré- Moldados</p>  <p>10, 25, 28</p> <p>Rolo 25 m</p> <p>*</p>	<p>IBC 3529 NBR 75 Sh A Ved. Formas Pré- Moldados</p>  <p>15, 22, 30</p> <p>Rolo 25 m</p> <p>*</p>	<p>IBC 3526 NBR 75 Sh A Ved. Formas Pré- Moldados</p>  <p>21, 4,5, 15, 35</p> <p>Rolo 25 m</p> <p>*</p>	<p>IBC 3641 NBR 80 Sh A Ved. Formas Pré- Moldados</p>  <p>11, 15, 15, 28, 11</p> <p>Rolo 25 m</p> <p>*</p>
<p>IBC 3643 NBR 80 Sh A Ved. Formas Pré- Moldados</p>  <p>13, 13, 3,5, 36</p> <p>Rolo 25 m</p> <p>*</p>	<p>IBC 3642 NBR 80 Sh A Ved. Formas Pré- Moldados</p>  <p>16, 5,5, 12, 11, 45</p> <p>Rolo 12 m</p> <p>*</p>		

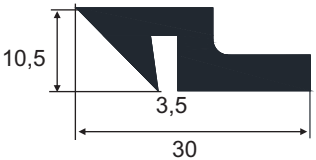
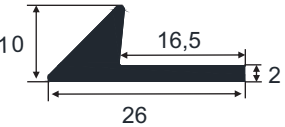
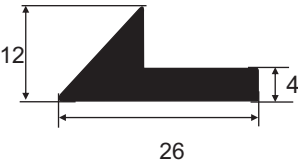
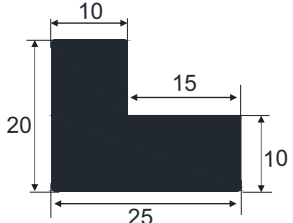
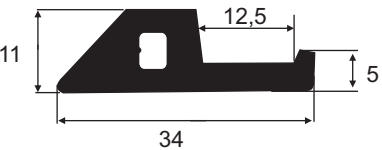
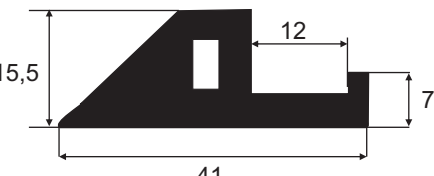
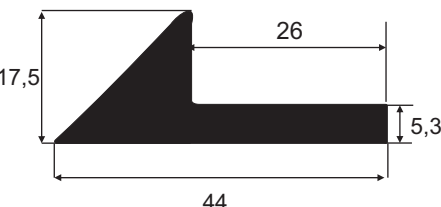
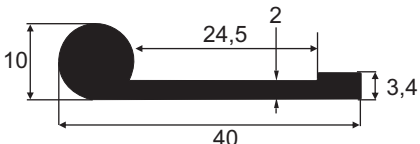
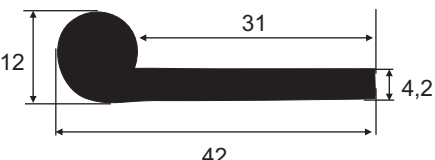
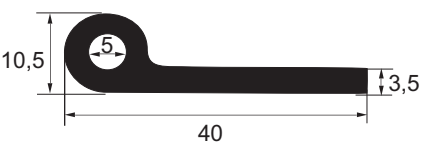
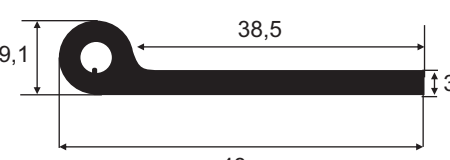
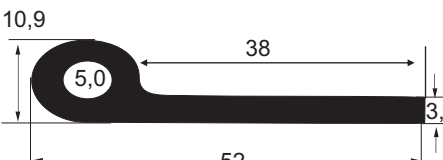
***** ITEM NOVO

<p>IBC 3580 NBR 75 Sh A Ved. Forma Pré Moldado</p>  <p>Rolo 50 m</p>	<p>IBC 3590 SBR 80 Sh A Ved. Forma Pré Moldado</p>  <p>Rolo 50 m</p>	<p>IBC 3528 NBR 75 Sh A Ved. Formas Pré- Moldados</p>  <p>Rolo 25 m</p>	<p>IBC 3647 NBR 75 Sh A</p>  <p>Rolo 25 m</p>
<p>IBC 3375 NBR 65 Sh A IBC 3496 NBR 70 Sh A Ved. Forma Pré Moldado</p>  <p>Rolo 50 m</p>	<p>IBC 3508 NBR 70 Sh A Ved. Formas Pré- Moldados</p>  <p>Rolo 25 m</p>	<p>IBC 3473 NBR 70 Sh A Ved. Formas Pré- Moldados</p>  <p>Rolo 25 m</p>	<p>IBC 3440 NBR 65 Sh A IBC 3583 NBR 70 Sh A Ved. Formas Pré- Moldados</p>  <p>Rolo 50 m</p>
<p>IBC 3542 NBR 65 Sh A Ved. Formas Pré- Moldados</p>  <p>Rolo 25 m</p>	<p>IBC 3560 NBR 65 Sh A</p>  <p>Rolo 25 m</p>	<p>IBC 3003 EPDM 65 Sh A Vedação Pára-Lama Agco</p>  <p>Rolo 25 m</p>	<p>IBC 3550 NBR 65 Sh A</p>  <p>Rolo 25 m</p>

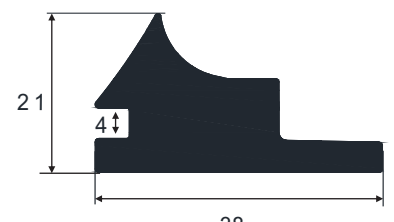
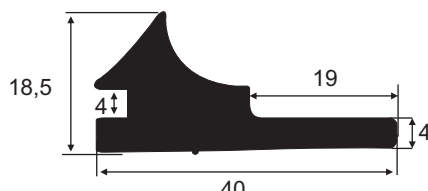
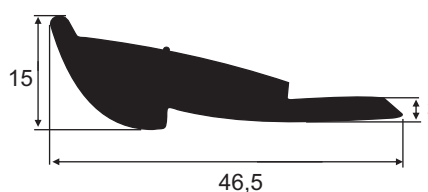
* ITEM NOVO

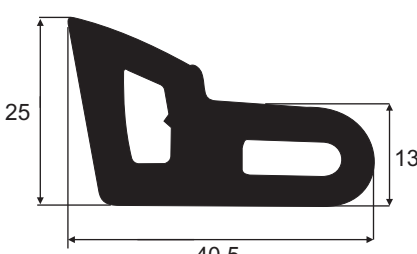
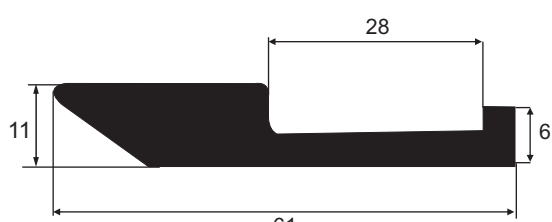
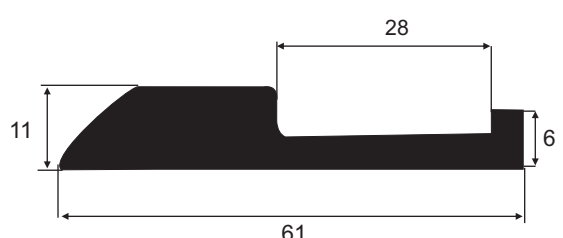
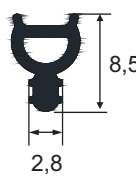
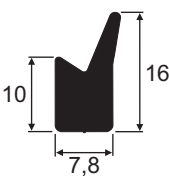
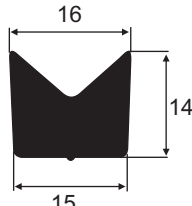
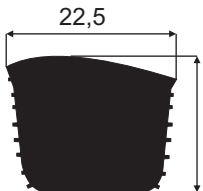
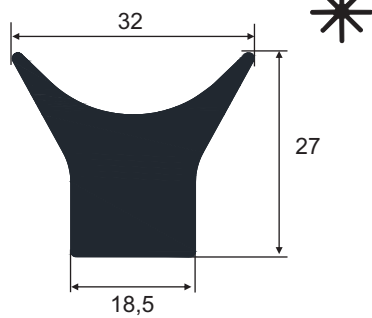
<p>IBC 3651 NBR 70 Sh A Ved. Formas Pré- Moldados</p>  <p>Rolo 25 m</p>	<p>IBC 3374 NBR 70 Sh A Ved. Formas Pré- Moldados</p>  <p>Rolo 25 m</p>	<p>IBC 3362 NBR 70 Sh A Ved. Formas Pré- Moldados</p>  <p>Rolo 25 m</p>	<p>IBC 3118 SBR 70 Sh A Ved. Formas Pré- Moldados</p>  <p>Rolo 25 m</p>	
<p>IBC 3363 NBR 70 Sh A Ved. Formas Pré- Moldados</p>  <p>Rolo 25 m</p>	<p>IBC 3521 NBR 70 Sh A Ved. Formas Pré- Moldados</p>  <p>Rolo 25 m</p>	<p>IBC 3523 NBR 70 Sh A Ved. Formas Pré- Moldados</p>  <p>Rolo 25 m</p>		
<p>IBC 3632 EPDM 70 Sh A *</p>  <p>Rolo 50 m</p>	<p>IBC 3434 NBR 70 Sh A</p>  <p>Rolo 50 m</p>	<p>IBC 3395 EPDM 65 Sh A</p>  <p>Rolo 25 m</p>	<p>IBC 3515 EPDM 70 Sh A *</p>  <p>Rolo 25 m</p>	<p>IBC 3679 EPDM 65 Sh A *</p>  <p>Rolo 30 m</p>

* ITEM NOVO

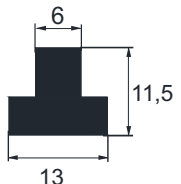
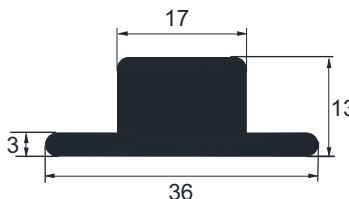
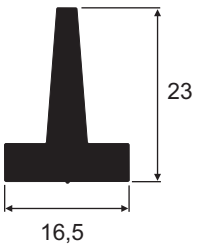
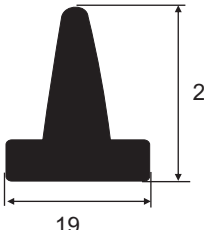
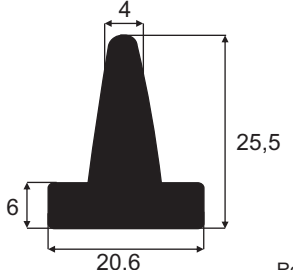
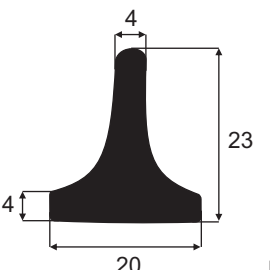
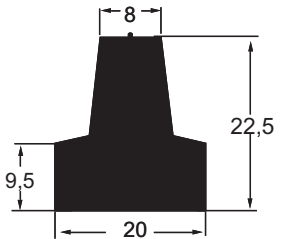
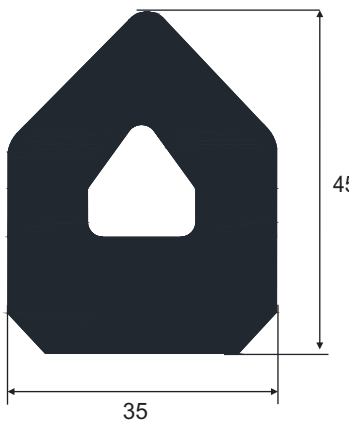
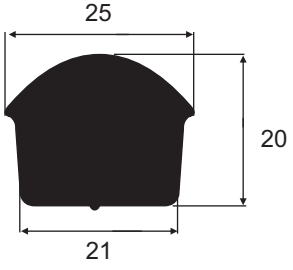
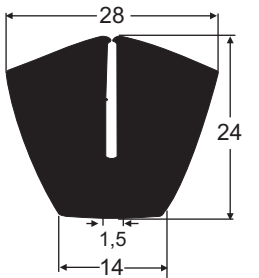
<p>IBC 3636 SBR 70 Sh A</p>  <p>Rolo 50 m</p>	<p>IBC 3656 NBR 75 Sh A Ved. Formas Pré-Moldados</p>  <p>Rolo 25 m</p>	<p>IBC 3432 NBR 85 Sh A IBC 3663 NBR 70 Sh A</p>  <p>Rolo 25 m</p>	<p>IBC 3475 SBR 80 Sh A</p>  <p>Rolo 25 m</p>
<p>IBC 3476 SBR 80 Sh A</p>  <p>Rolo 25 m</p>	<p>IBC 3477 SBR 80 Sh A</p>  <p>Rolo 25 m</p>	<p>IBC 3184 EPDM 80 Sh A Máquina Madeira MDF</p>  <p>Rolo 25 m</p>	<p>IBC 3615 SBR 60 Sh A</p>  <p>Rolo 25 m</p>
<p>IBC 3230 SBR 60 Sh A Batente para Equip. Hospitalar</p>  <p>Rolo 25 m</p>	<p>IBC 3403 SBR 70 Sh A</p>  <p>Rolo 25 m</p>		

* ITEM NOVO

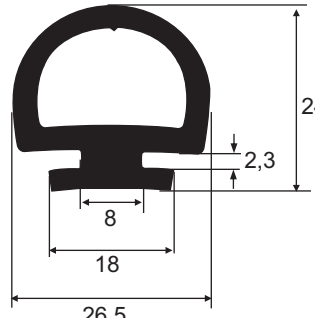
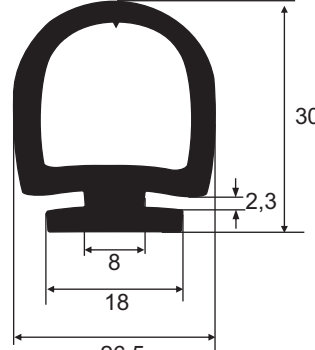
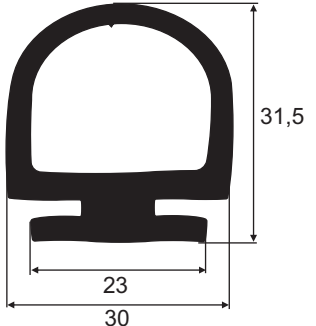
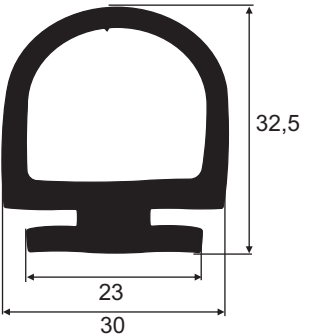
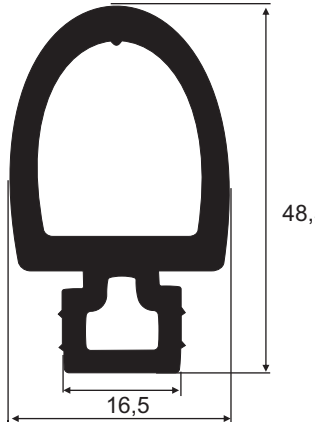
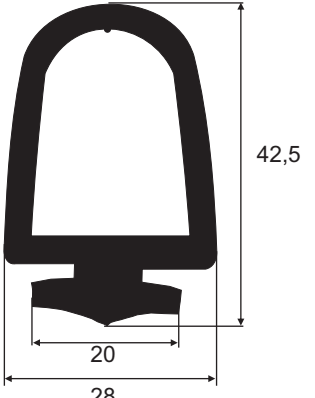
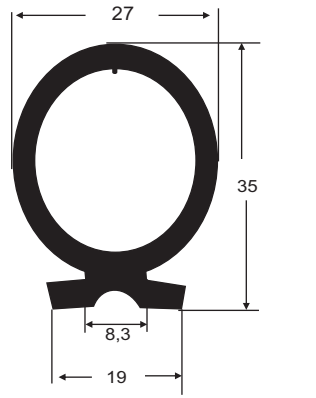
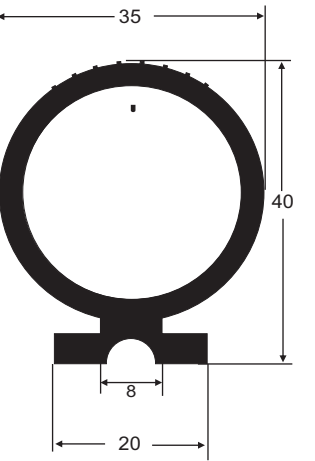
<p>IBC 3323 SBR 70 Sh A IBC 7130 SBR 70 Sh A Vedação Central Porta Ônibus Ciferal Padron Rio, Glsbus</p>  <p>Rolo 25 m</p>	<p>IBC 3325 SBR 70 Sh A IBC 7131 SBR 80 Sh A Vedação Porta Ônibus Caio, Gabriela, Amélia, Vitória</p>  <p>Rolo de 25m</p>	<p>IBC 3324 SBR 80 Sh A IBC 7118 SBR 80 Sh Vedação Central Porta Ônibus Thanco, Scorpion, Micro</p>  <p>Rolo de 25m</p>	<p>IBC 3547 EPDM 80 Sh A Vedação Porta de Ônibus</p>  <p>Rolo 25 m</p>
<p>IBC 3330 SBR 80 Sh A IBC 7136 SBR 80 Sh A Vedação Porta Ônibus Comil Svelto I, II Dopio Versátil, MP Torino Allegro GV</p>  <p>Rolo de 25m</p>	<p>IBC 3326 SBR 80 Sh A IBC 7132 SBR 80 Sh A Vedação Central Portas Ônibus Thanco, Condor Falcão, Águia, Pégasus, Ciferal Tocantins Fênix Alvorada</p>  <p>Rolo de 25m</p>	<p>IBC 3135 EPDM 65 Sh A Vedação Portas Secadora Madeira</p>  <p>Rolo 25 m</p>	<p>IBC 3295 EPDM 80 Sh A Vedação Portas Secadora Madeira</p>  <p>Rolo 25 m</p>

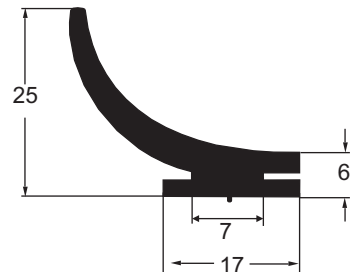
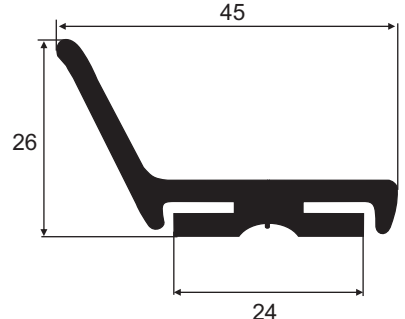
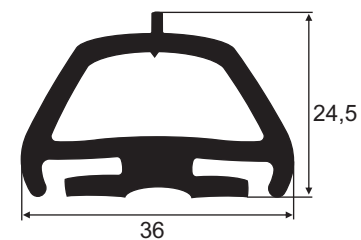
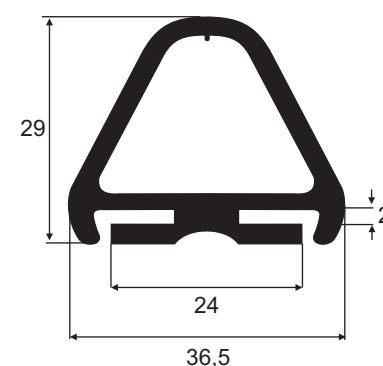
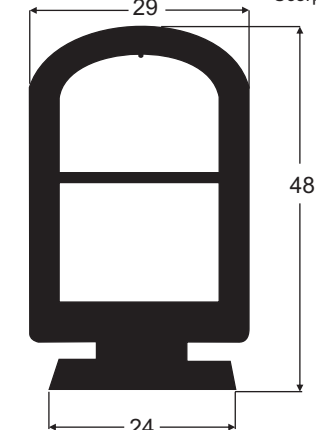
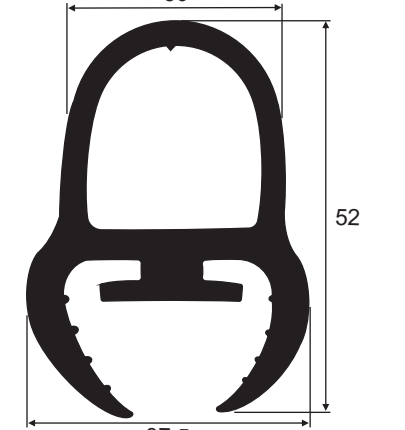
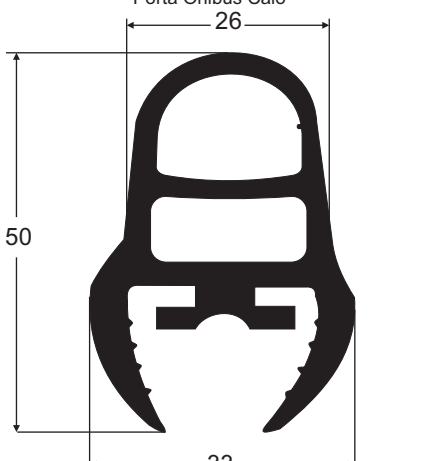
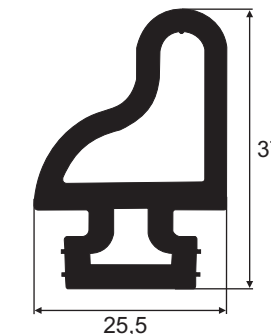
<p>IBC 3079 SBR 70 Sh A * IBC 7002 SBR 70 Sh A Vedação Portas Ônibus Caio</p>  <p>Rolo 50 m</p>	<p>IBC 3232 SBR 80 Sh A IBC 7127 SBR 80 Sh A Vedação Lateral portas Busscar Urbanuss e Interbuss</p>  <p>Rolo 50 m</p>	<p>IBC 3327 SBR 80 Sh A IBC 7133 SBR 80 Sh A Vedação Central Portas Busscar Urbanuss Pluss, Interbuss</p>  <p>Rolo 25 m</p>	<p>IBC 3233 SBR 80 Sh A IBC 7128 SBR 80 Sh A Vedação Portas Ônibus Busscar Micruss e Mini Micruss</p>  <p>Rolo 25m</p>
<p>IBC 3136 SBR 70 Sh A IBC 7016 SBR 70 Sh A) Vedação Portas Ônibus Mega, Neobus, Thanco Scorpion</p>  <p>Rolo 25m</p>	<p>IBC 3331 SBR 80 Sh A IBC 7137 SBR 80 Sh A Vedação Porta Ônibus Caio, Alpha</p>  <p>Rolo 25m</p>	<p>IBC 3106 SBR 70 Sh A IBC 7003 SBR 70 Sh A Porta Ônibus Caio</p>  <p>Rolo 25m</p>	<p>IBC 3444 EPDM 75 Sh A Vedação Porta Ônibus SV 2008 Urbano Comil</p>  <p>Rolo 25m</p>

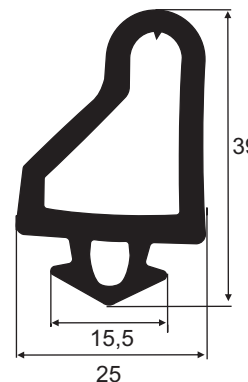
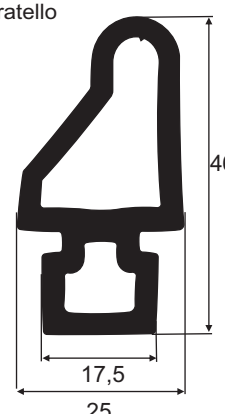
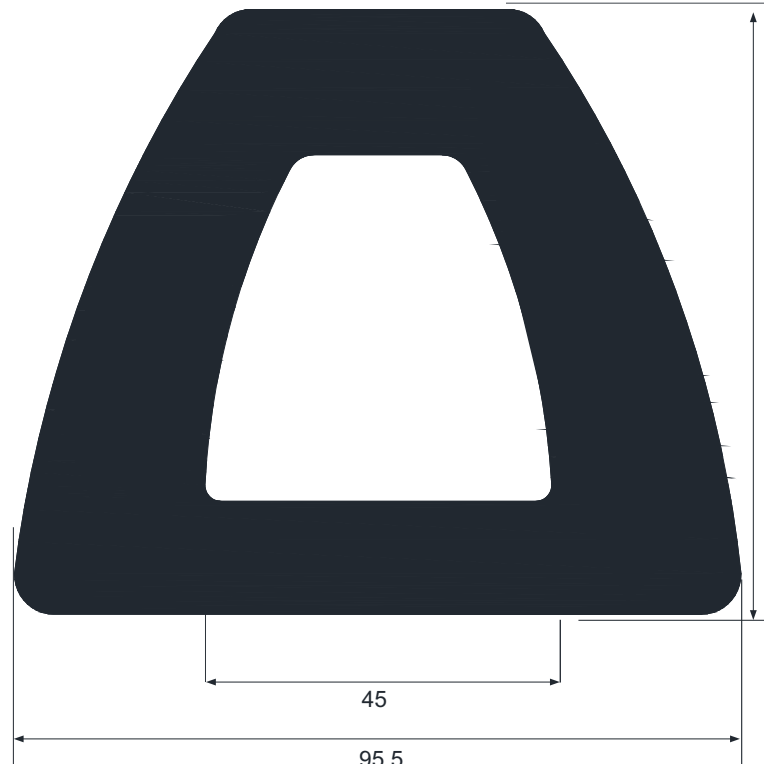
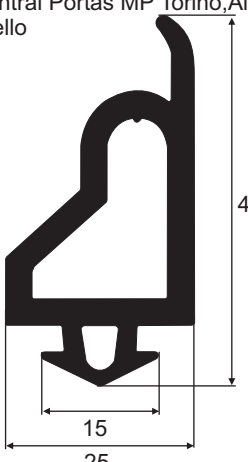
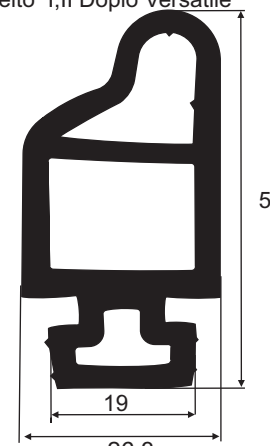
<p>IBC 3328 SBR 80 Sh A IBC 7134 SBR 80 Sh A Vedação Central Portas MP Torino, Allegro GV Volare, Fratello</p>  <p>39 15,5 25</p> <p>Rolo 25m</p>	<p>IBC 3329 SBR 80 Sh A IBC 7135 SBR 80 Sh A Ved. Central Port. Ônibus Busscar Micruss e Mini Micruss Vedação Central Portas MP Torino, Allegro GV Volare, Fratello</p>  <p>46 17,5 25</p> <p>Rolo 25m</p>	<p>IBC 3644 EPDM 75 Sh A <u>Batente Carro Choque</u></p>  <p>75 45 95,5</p> <p>Rolo 3m</p> <p style="text-align: right;">*</p>
<p>IBC 3412 SBR 80 Sh A Ved. Central Port. Ônibus Busscar Micruss e Mini Micruss Vedação Central Portas MP Torino, Allegro GV Volare, Fratello</p>  <p>49 15 25</p> <p>Rolo 25m</p>	<p>IBC 3320 SBR 80 Sh A IBC 7129 SBR 80 Sh A Porta Ônibus, Vedação Porta Ônibus Comi I Svelto I, II Dupio Versátile</p>  <p>50 19 26,3</p> <p>Rolo 25m</p>	



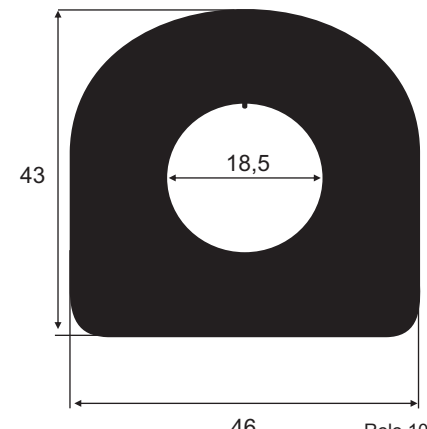
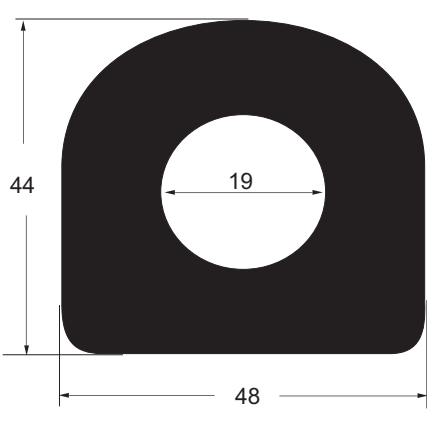
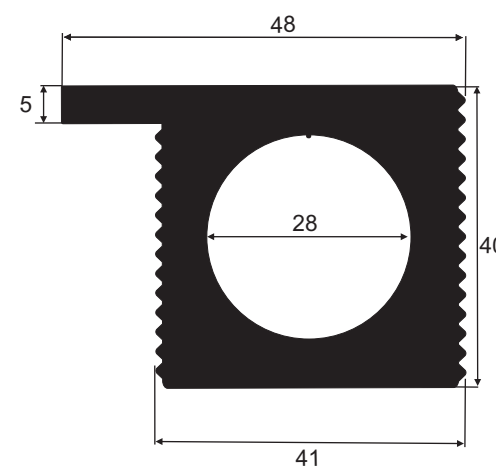
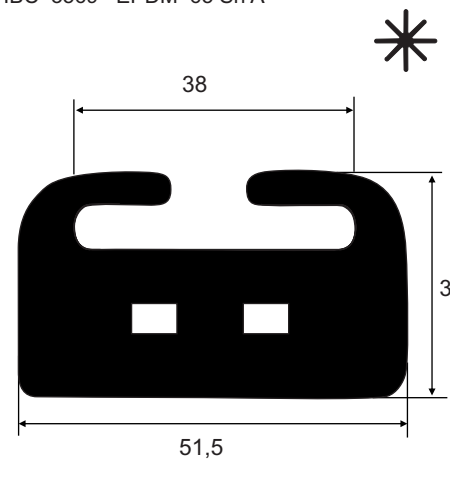
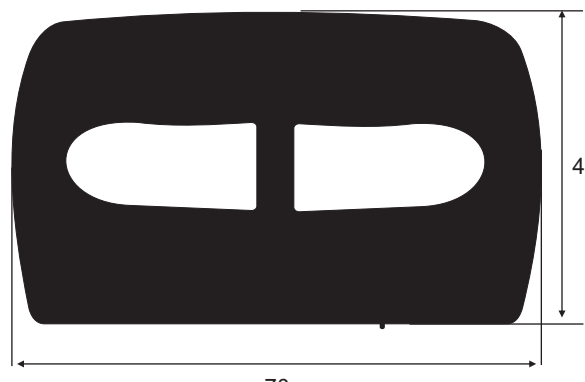
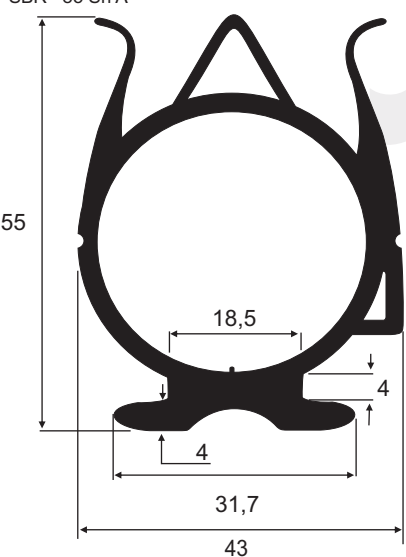



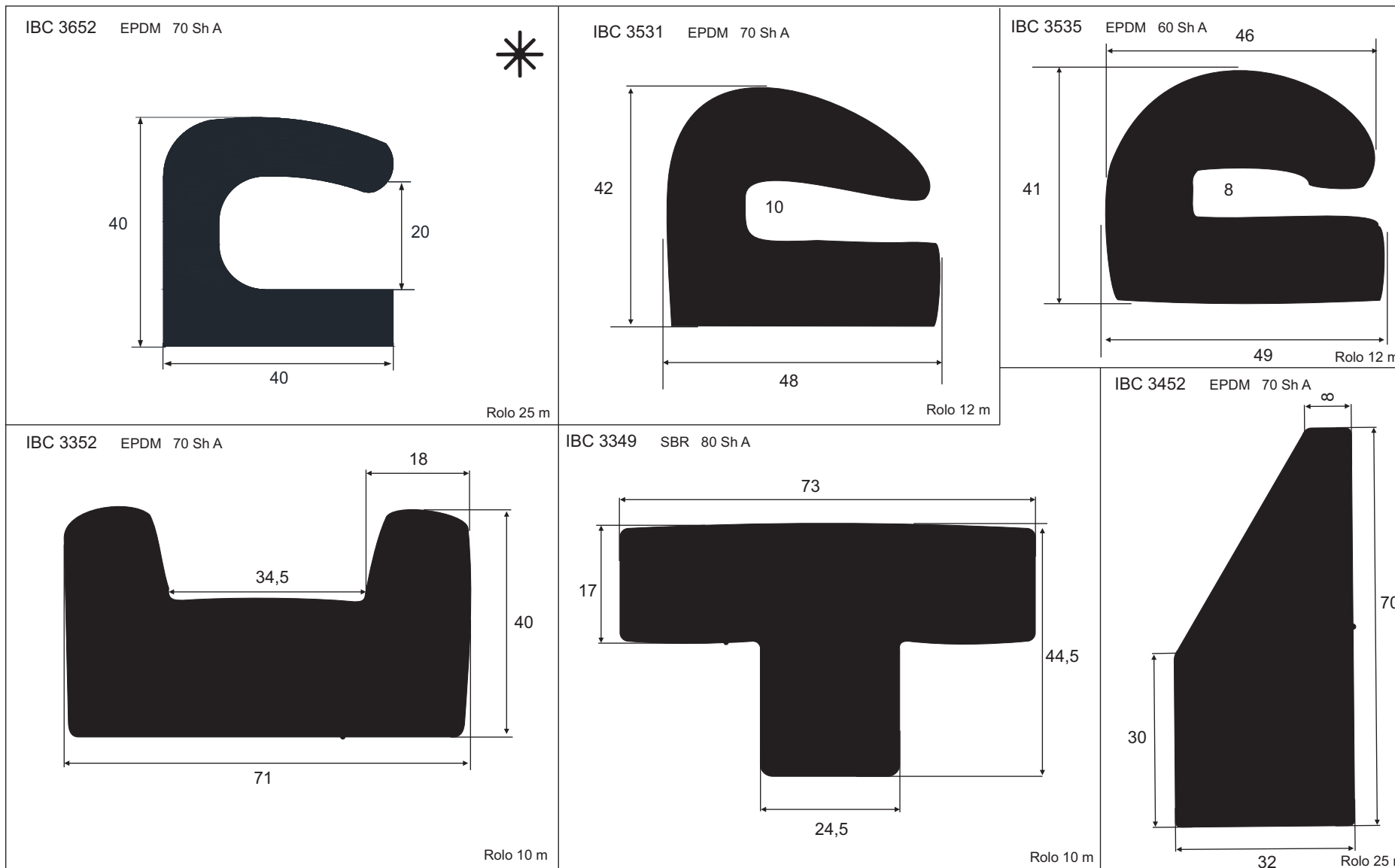

* ITEM NOVO

<p>IBC 3252 SBR 70 Sh A</p>  <p>Rolo 10 m</p>	<p>IBC 3549 NBR 70 Sh A</p>  <p>Barra 10 m</p>	<p>IBC 3207 SBR 80 Sh A</p>  <p>Barras 10m</p>
<p>IBC 3569 EPDM 65 Sh A</p>  <p>Barras 15m</p>	<p>IBC 3288 SBR 50 Sh A</p>  <p>Barras 10m</p>	<p>IBC 3263 SBR 85 Sh A</p>  <p>Rolo 25 m</p>

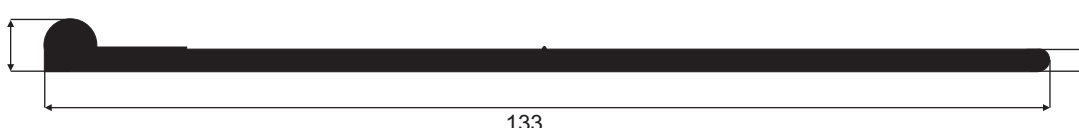
* ITEM NOVO

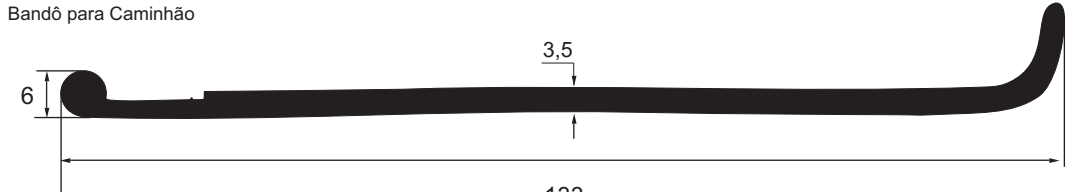

* ITEM NOVO

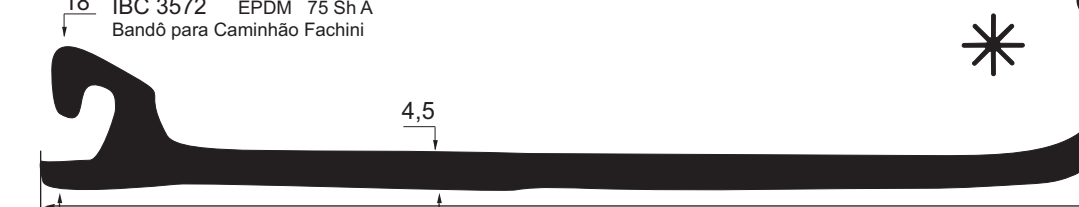
<p>IBC 3610 EPDM 75 Sh A Bandô Randon</p>  <p>5,5 3 130</p> <p>Rolo 32 m</p>	<p>IBC 3128 SBR 60 Sh A Protetor Pó Pára-Lama M. Benz</p>  <p>60 2</p> <p>Rolo 25 m</p>
<p>IBC 3466 EPDM 70 Sh A Bandô Linshalm</p>  <p>7 3 133</p> <p>Rolo 25 m</p>	<p>IBC 3262 SBR 80 Sh A</p>  <p>10 66</p> <p>Rolo 25 m</p>
<p>IBC 3396 EPDM 80 Sh A Bandô A Guerra</p>  <p>6,3 144</p> <p>Rolo 25 m</p>	<p>IBC 3100 EPDM 60 Sh A</p>  <p>10,5 63,5</p> <p>Rolo 25 m</p>
<p>IBC 3565 EPDM 75 Sh A Bandô para Caminhão</p>  <p>6 3,5 133</p> <p>Rolo 32 m</p>	<p>IBC 3389 EPDM 65 Sh A</p>  <p>5 70</p> <p>Rolo 25 m</p>
<p>18 IBC 3572 EPDM 75 Sh A Bandô para Caminhão Fachini</p>  <p>4,5 142,5</p> <p>Rolo 25 m</p>	

* ITEM NOVO

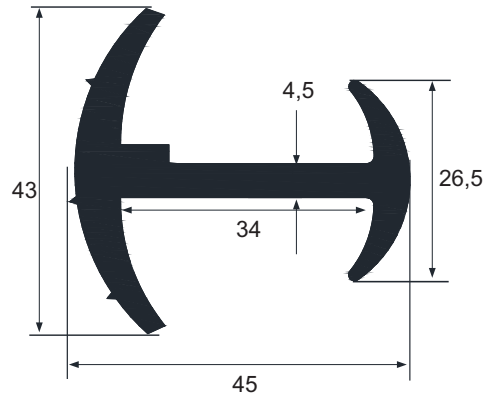
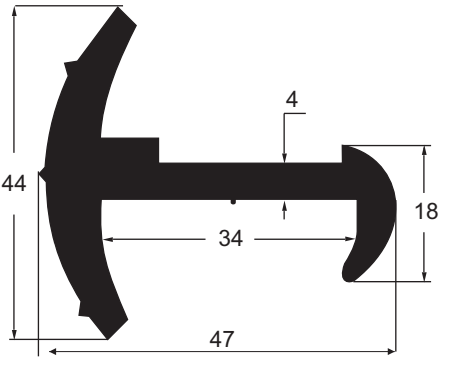
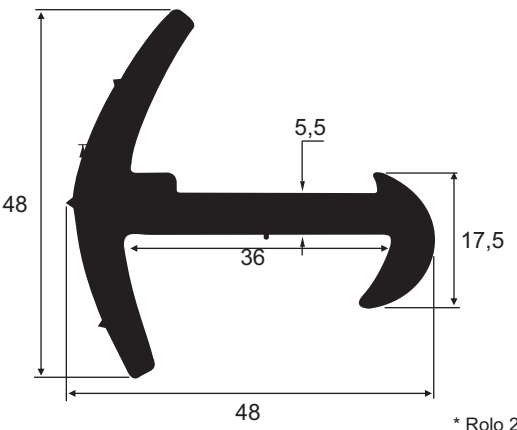
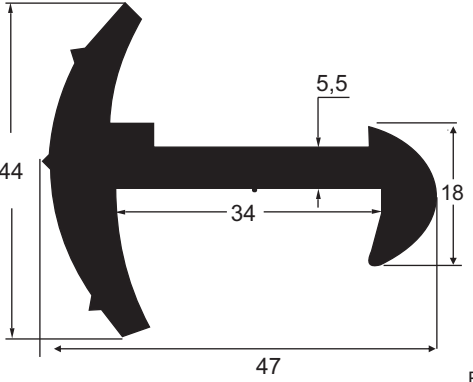
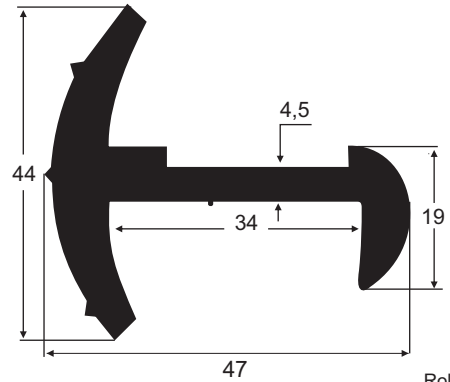
<p>IBC 3670 EPDM 80 Sh A Vedação Porta Furgões *</p>  <p>Rolo 25 m</p>	<p>IBC 3037 SBR 80 Sh A * IBC 7008 SBR 80 Sh A (Barra c/ 2,50 m) * IBC 7009 SBR 80 Sh A (Barra c/ 4,60 m) IBC 7066 SBR 80 Sh A (Barra c/ 2,80 m) IBC 7067 SBR 80 Sh A (Barra c/ 2,30 m) IBC 7075 SBR 80 Sh A (Barra c/ 3,00 m) IBC 3666 EPDM 80 Sh A Vedação Porta Furgões *</p>  <p>* Rolo 25 m</p>	<p>IBC 3107 SBR 80 Sh A * IBC 3436 SBR 85 Sh A * IBC 7004 SBR 80 Sh A (Barra c/ 2,80 m) * IBC 7005 SBR 80 Sh A (Barra c/ 2,30 m) IBC 3661 SBR 75 Sh A Vedação Porta Furgões *</p>  <p>* Rolo 25 m</p>
<p>IBC 3038 SBR 80 Sh A Vedação Porta Furgões</p>  <p>Rolo 25 m</p>	<p>IBC 3223 SBR 85 Sh A Vedação Porta Furgões</p>  <p>Rolo 25 m</p>	

* ITEM NOVO

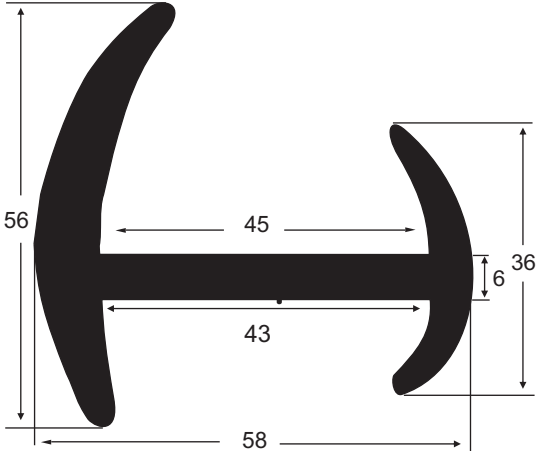
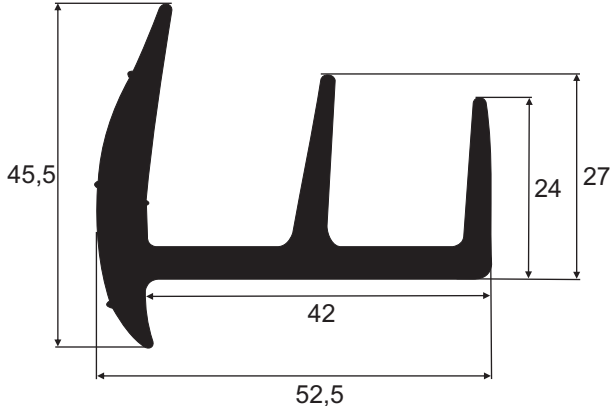
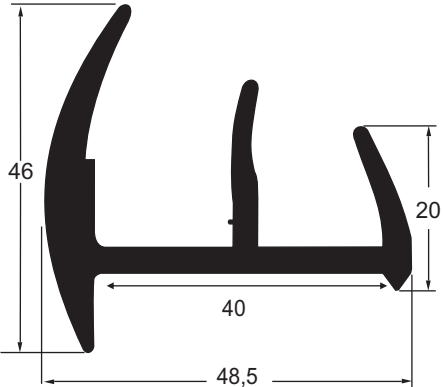
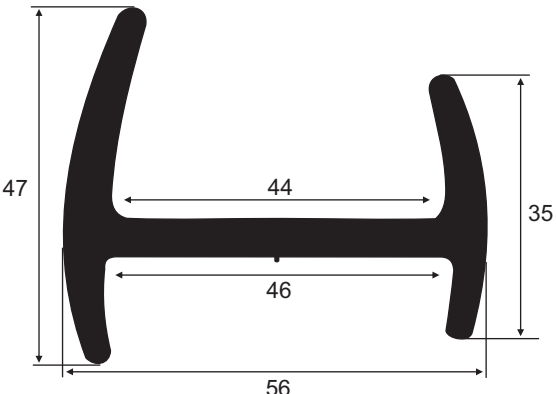
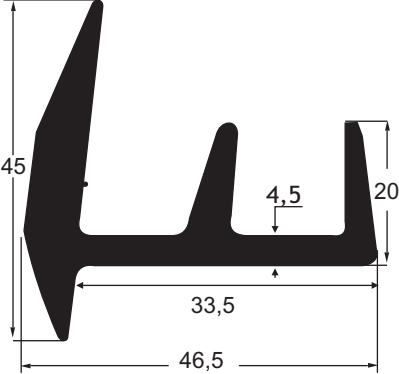
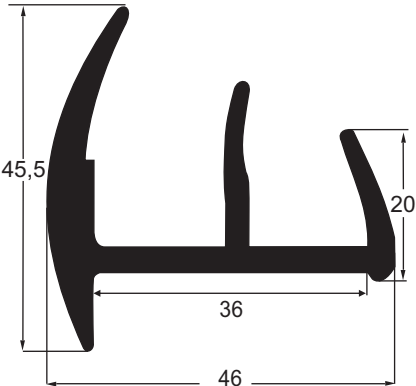
<p>IBC 3148 SBR 80 Sh A* IBC 7054 SBR 80 Sh A (Barra c/ 5,00 m) IBC 7055 SBR 80 Sh A (Barra c/ 2,60 m) IBC 7064 SBR 80 Sh A (Barra c/ 2,80 m) IBC 7065 SBR 80 Sh A (Barra c/ 2,30 m) Vedação Porta Furgões - Randon</p>  <p>Rolo 25 m</p>	<p>IBC 3275 EPDM 65 Sh A Vedação Caixa Rancho Furgões</p>  <p>Rolo 25 m</p>	<p>IBC 3317 EPDM 70 Sh A Vedação Caixa Rancho Furgões</p>  <p>Rolo 25 m</p>
<p>IBC 3296 SBR 80 Sh A Vedação Porta Furgões</p>  <p>Rolo 25 m</p>	<p>IBC 3093 EPDM 65 Sh A Vedação Caixa Rancho Furgões</p>  <p>Rolo 25 m</p>	<p>IBC 3309 EPDM 75 Sh A IBC 3637 EPDM 80 Sh A Vedação Caixa Rancho Furgões</p>  <p>Rolo 25 m</p>

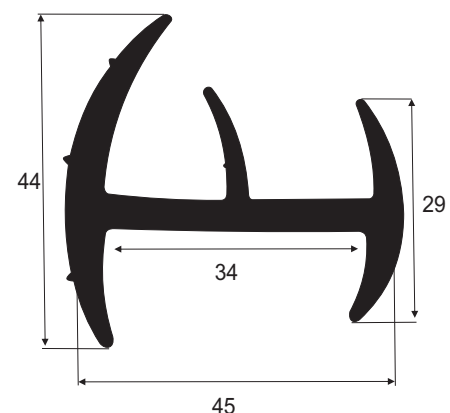
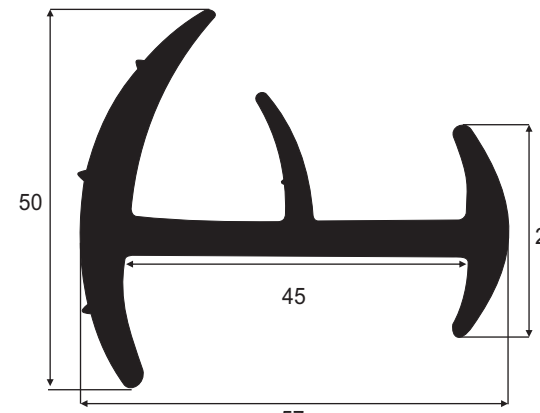
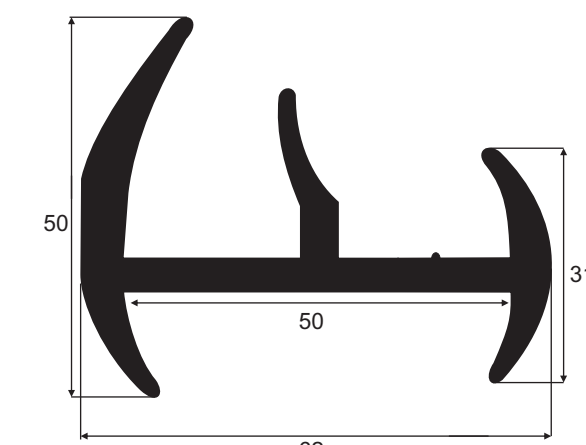
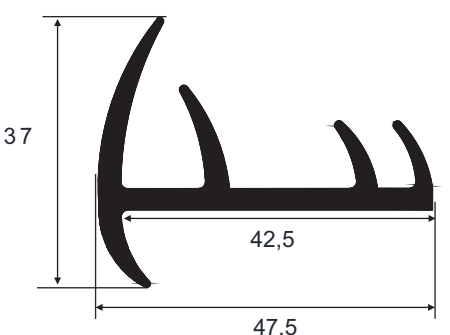
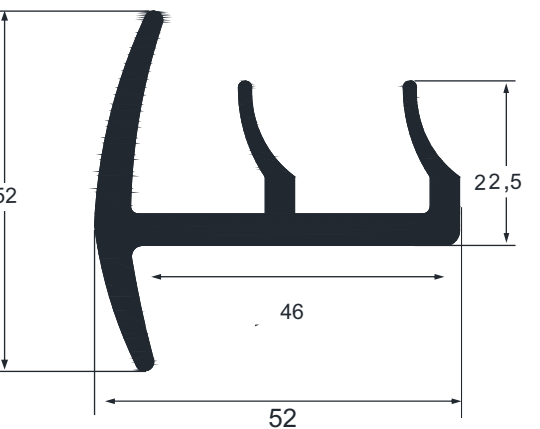
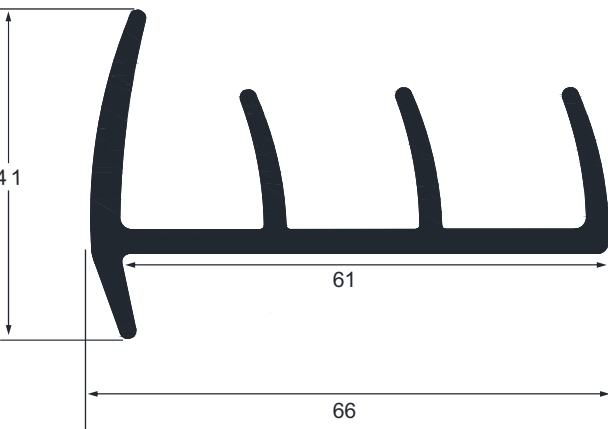

 **ITEM NOVO**

<p>IBC 3457 EPDM 75 Sh A</p>  <p>Rolo 25 m</p>	<p>IBC 3486 EPDM 75 Sh A</p>  <p>Rolo 25 m</p>	<p>IBC 3487 EPDM 70 Sh A</p>  <p>Rolo 25 m</p>
<p>IBC 3382 EPDM 70 Sh A</p>  <p>Rolo 25 m</p>	<p>IBC 3600 EPDM 75 Sh A</p>  <p>Rolo 25 m</p>	<p>IBC 3595 EPDM 75 Sh A</p>  <p>Rolo 25 m</p>

* ITEM NOVO

IBC 3536 EPDM 75 Sh A
Vedação Porta Frigorífico

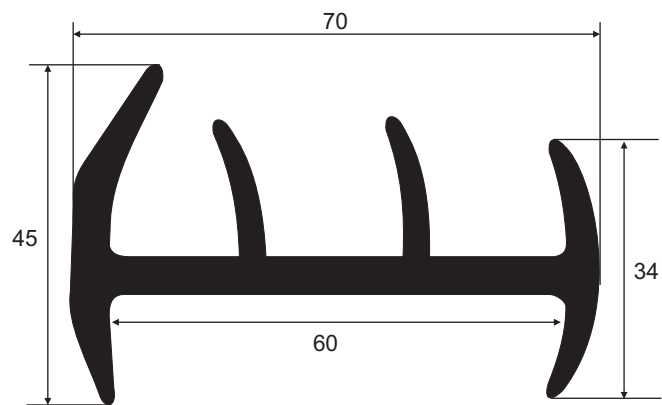

Rolo 25 m

IBC 3538 EPDM 75 Sh A
Vedação Porta Frigorífico

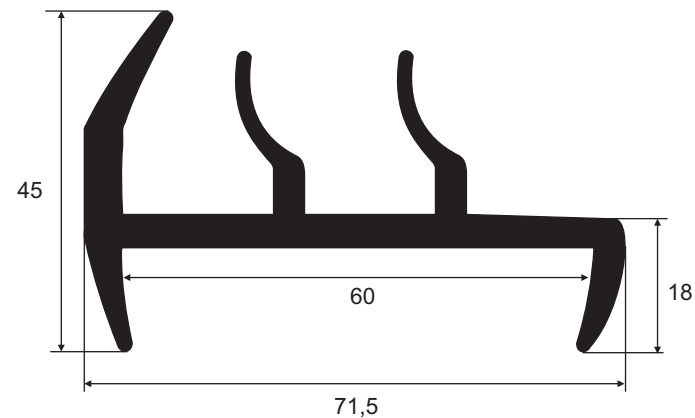

Rolo 25 m

IBC 3413 EPDM 75 Sh A
Vedação Porta Frigorífico

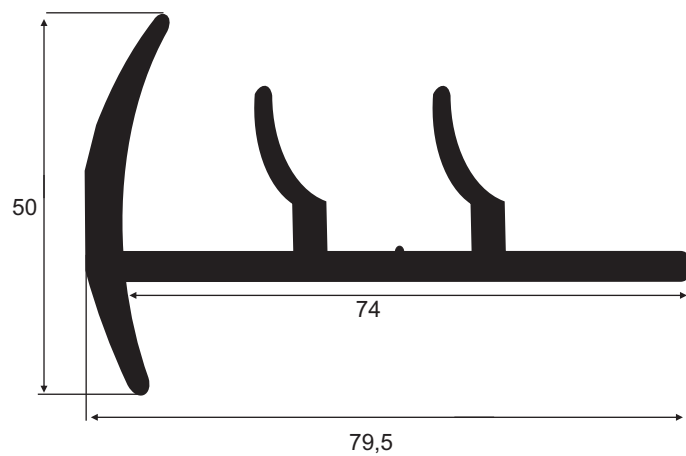

Rolo 25 m

 ITEM NOVO

IBC 3139 EPDM 75 Sh A
Vedação Furgão Frigorífico

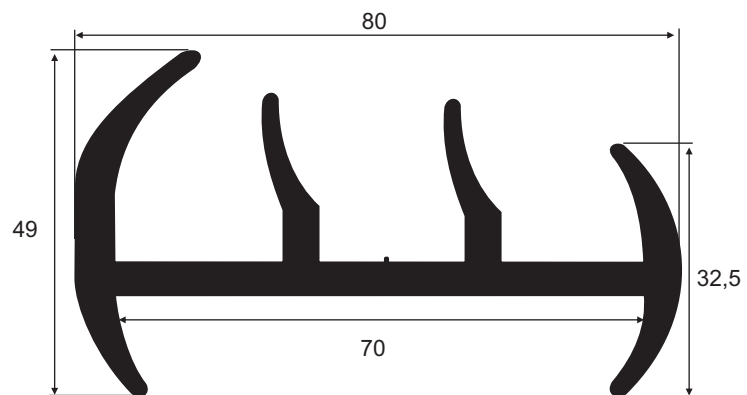

Rolo 25 m

IBC 3305 EPDM 75 Sh A
Vedação Furgões Frigoríficos Niju

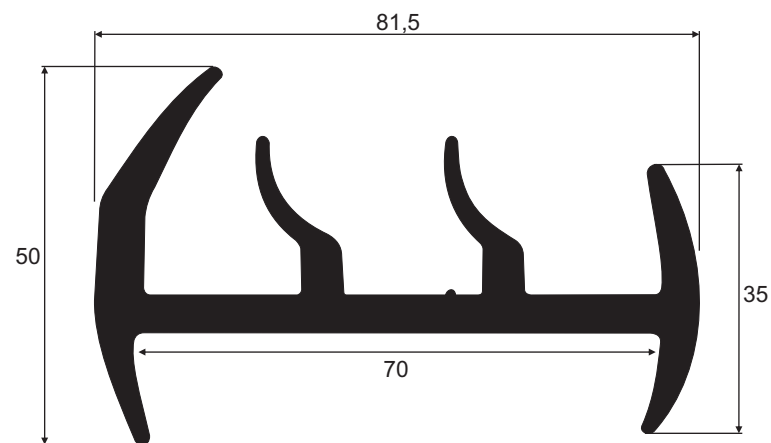

Rolo 25 m

IBC 3379 EPDM 70 Sh A
Vedação Furgões Frigoríficos Randon

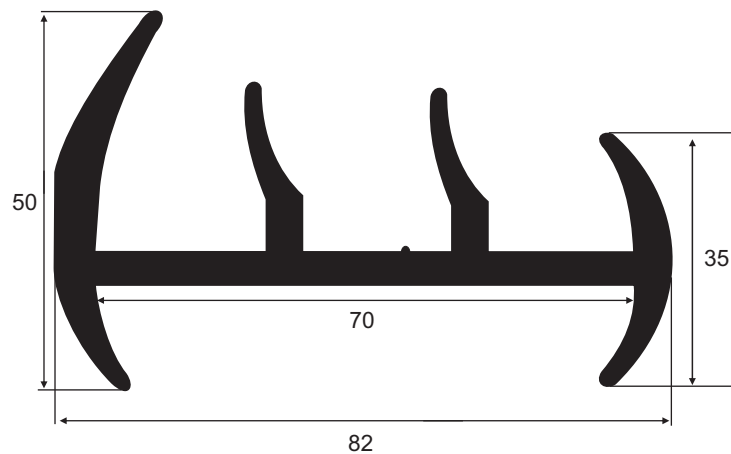

Rolo 25 m

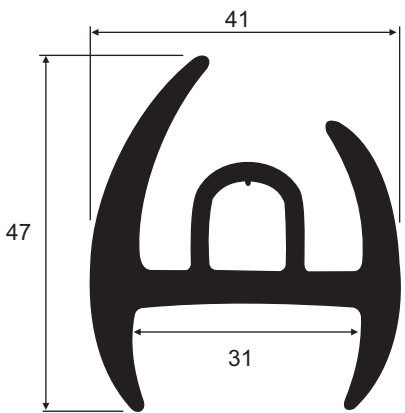
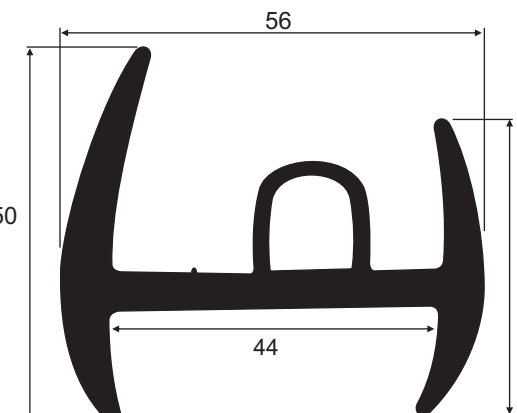
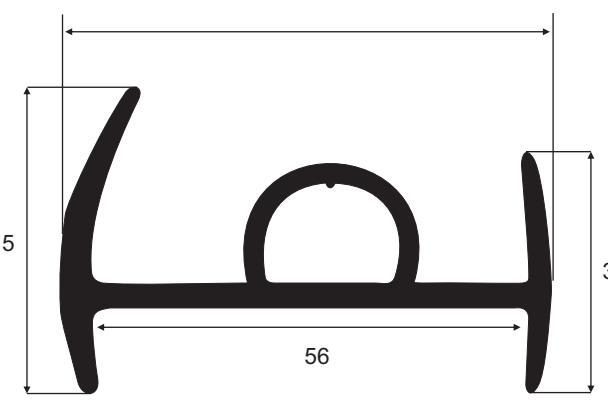
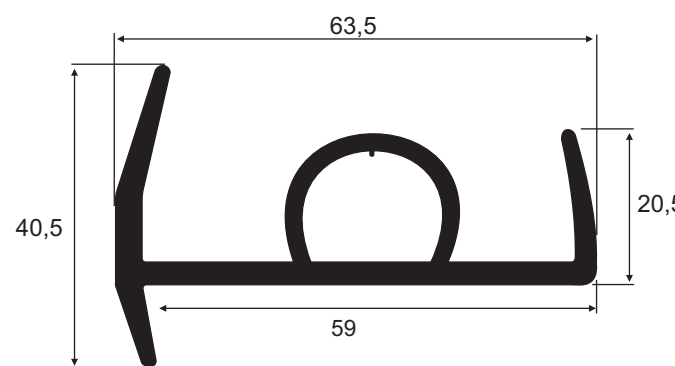
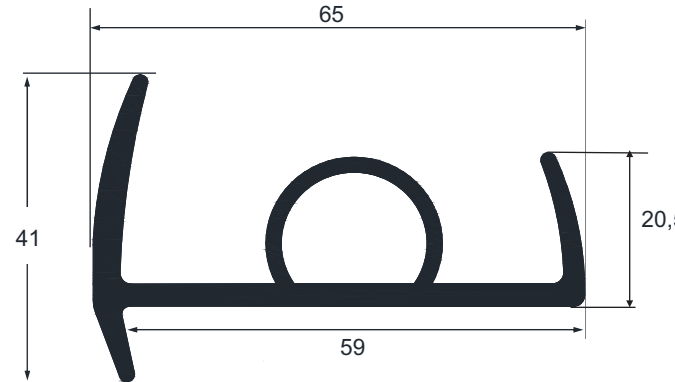
<p>IBC 3313 EPDM 70 Sh A Vedação Caixa Rancho</p>  <p>Rolo 25m</p>	<p>IBC 3306 EPDM 70 Sh A Vedação Caixa Rancho</p>  <p>Rolo 25 m</p>	<p>IBC 3509 EPDM 70 Sh A Vedação portas furgão Carropel</p>  <p>Rolo 25m</p> <p style="text-align: right;">✱</p>
<p>IBC 3310 EPDM 75 Sh A IBC 7339 1.900mm. IBC 7340 2.300mm. IBC 7341 2.500mm. IBC 7406 2.100mm. Vedação portas furgão HC</p>  <p>Rolo 25 m</p>	<p>IBC 3592 EPDM 75 Sh A Vedação portas furgão HC</p>  <p>Rolo 25m</p> <p style="text-align: right;">✱</p>	

✱ ITEM NOVO

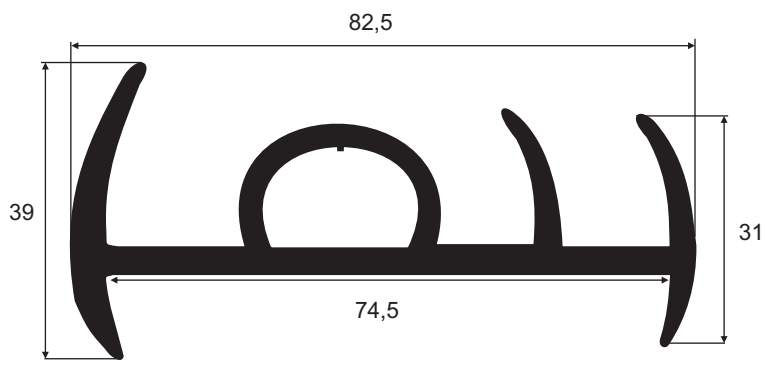
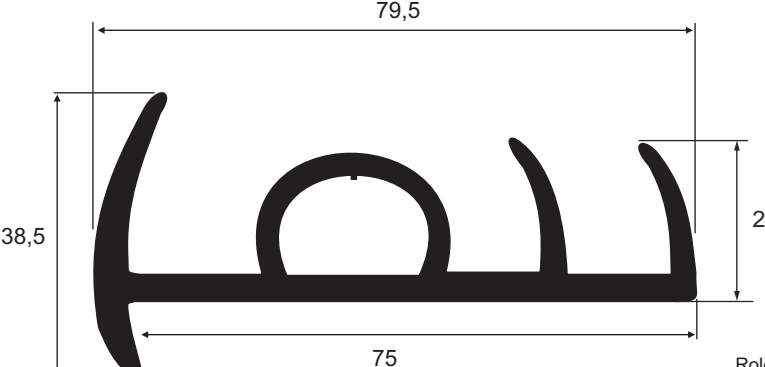
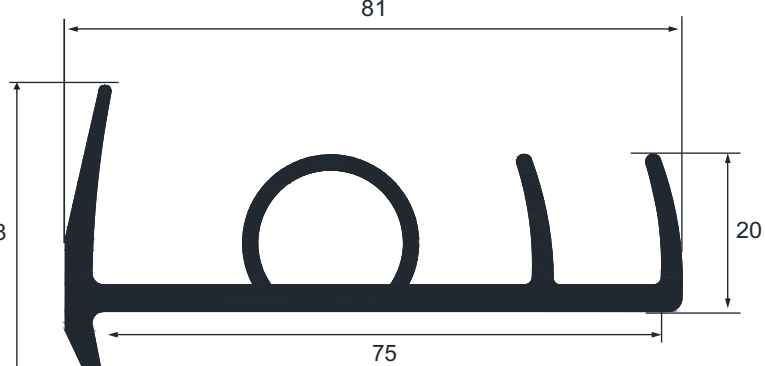
<p>IBC 3471 EPDM 75 Sh A</p>  <p>Rolo 25 m</p>	<p>IBC 3050 EPDM 75 Sh A Vedação Furgão Frigorífico</p>  <p>Rolo 25 m</p>
<p>IBC 3596 EPDM 75 Sh A</p>  <p>Rolo 25 m</p>	

* ITEM NOVO

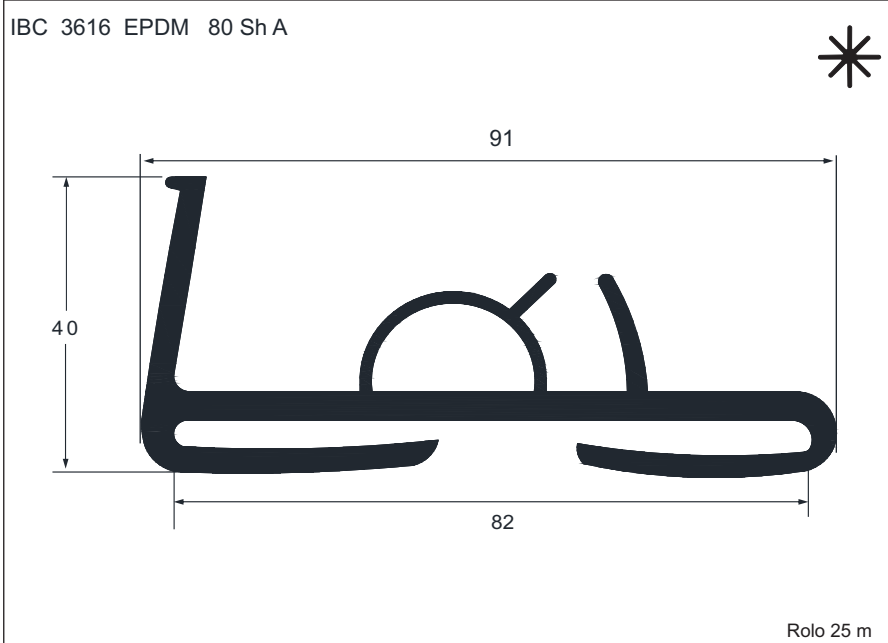
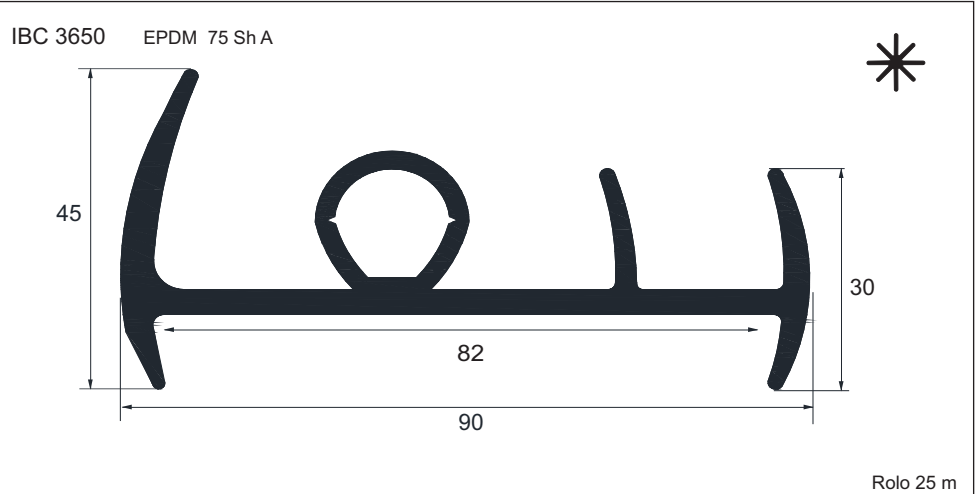
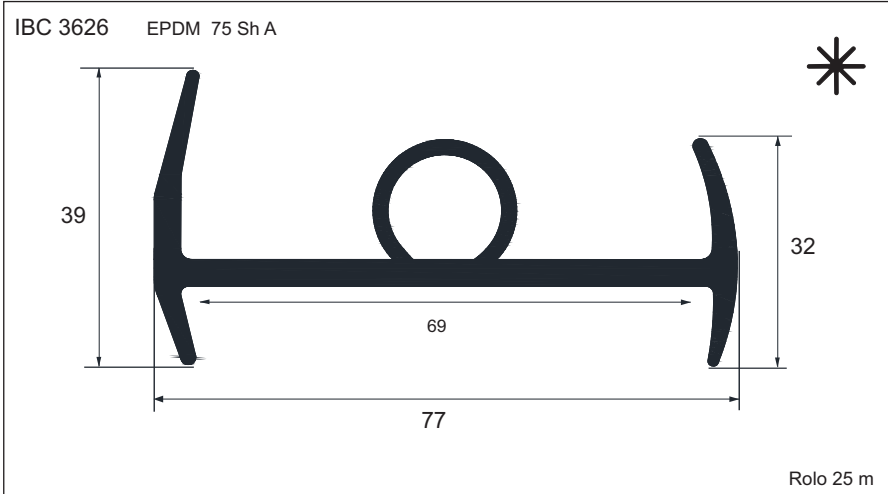

* ITEM NOVO

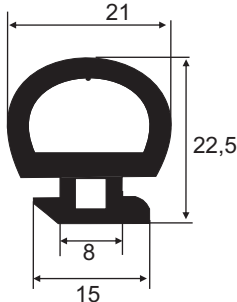
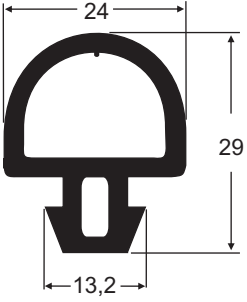
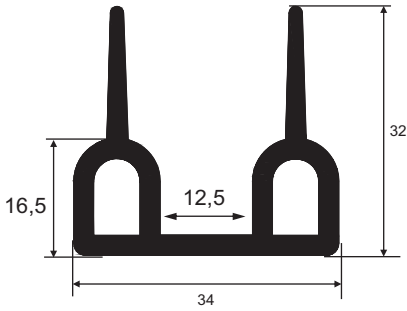
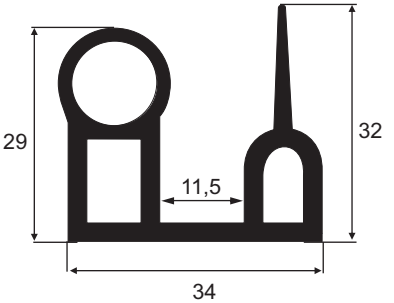
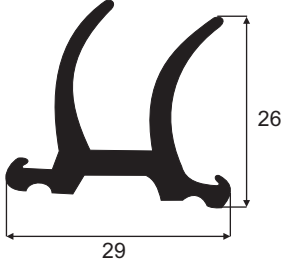
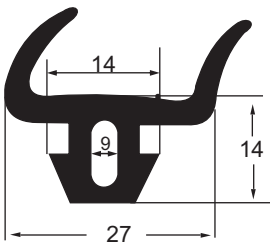
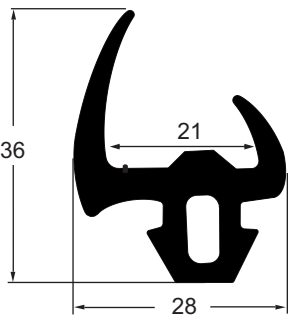
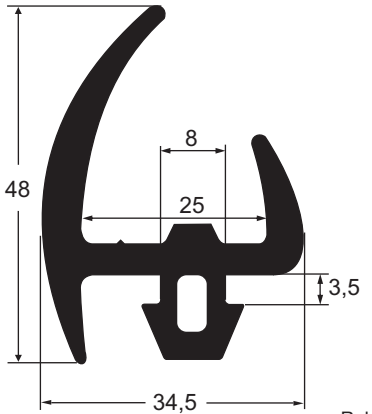
<p>IBC 3355 SBR 70 Sh A</p>  <p>Rolo 25 m</p>	<p>IBC 3297 EPDM 70 Sh A</p>  <p>Rolo 25 m</p>	<p>IBC 3584 EPDM 75 Sh A *</p>  <p>Rolo 25 m</p>	<p>IBC 3524 EPDM 75 Sh A *</p>  <p>Rolo 25 m</p>
<p>IBC 3525 EPDM 75 Sh A</p>  <p>Rolo 25 m</p>	<p>IBC 3048 EPDM 65 Sh A Vedação Furgão Fachini *</p>  <p>Rolo 25 m</p>	<p>IBC 3307 EPDM 70 Sh A Vedação Porta Furgão Fachini</p>  <p>Rolo 25 m</p>	<p>IBC 3049 EPDM 70 Sh A Vedação Porta Furgão Fachini</p>  <p>Rolo 25 m</p>

* ITEM NOVO

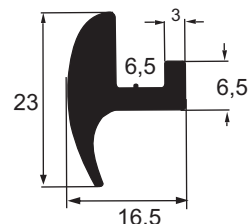
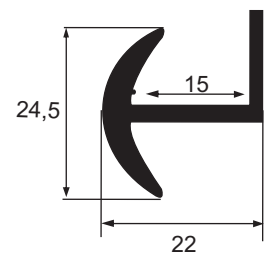
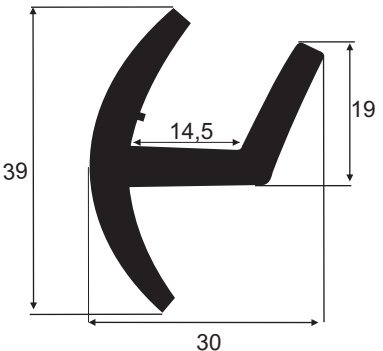
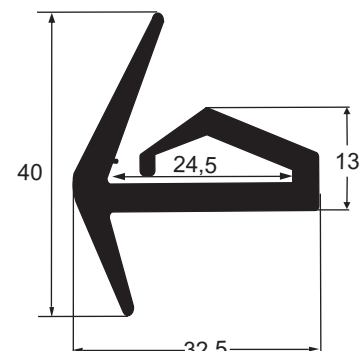
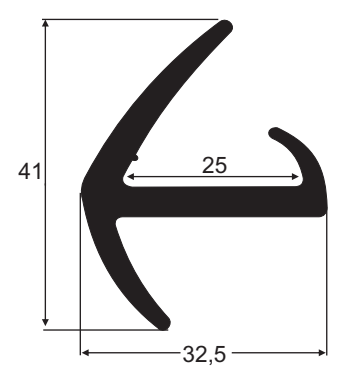
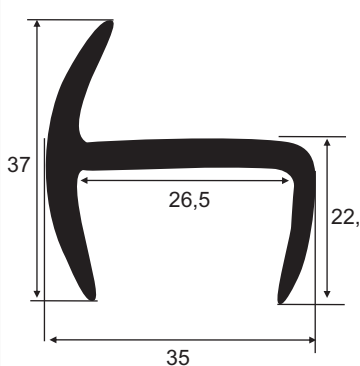
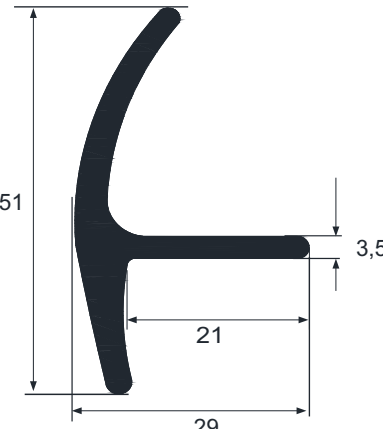
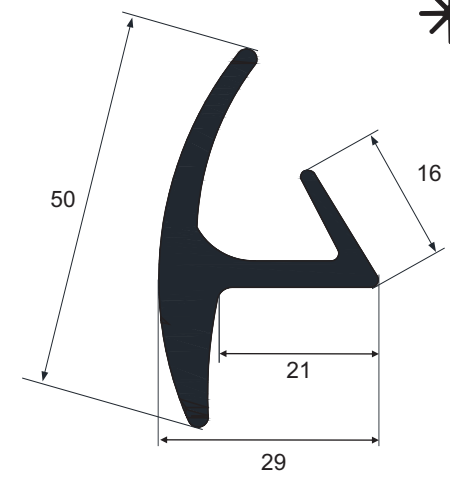
<p>IBC 3159 SBR 60 Sh A</p>  <p>Rolo 50 m</p>	<p>IBC 3055 SBR 70 Sh A</p>  <p>Rolo 25 m</p>	<p>IBC 3250 SBR 80 Sh A</p>  <p>Rolo 25 m</p>	<p>IBC 3045 SBR 80 Sh A Vedação Furgão Diversos</p>  <p>Rolo 25 m</p>
<p>IBC 3390 EPDM 70 Sh A IBC 3438 EPDM 80 Sh A Vedação Portas Furgões</p>  <p>Rolo 25 m</p>	<p>IBC 3545 EPDM 80 Sh A</p>  <p>Rolo 25 m</p>	<p>IBC 3673 EPDM 80 Sh A *</p>  <p>Rolo 25 m</p>	<p>IBC 3667 EPDM 80 Sh A *</p>  <p>Rolo 25 m</p>

* ITEM NOVO

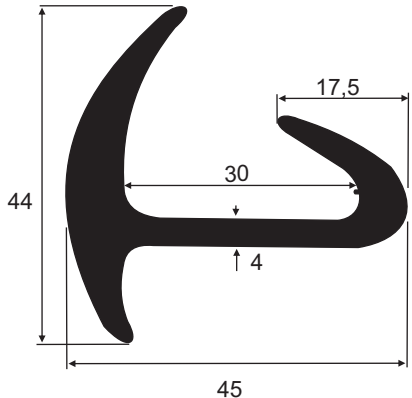
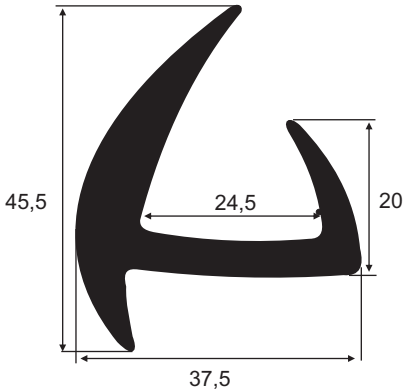
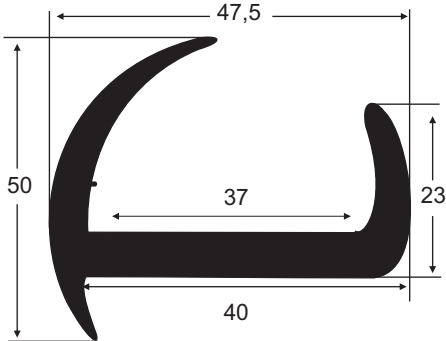
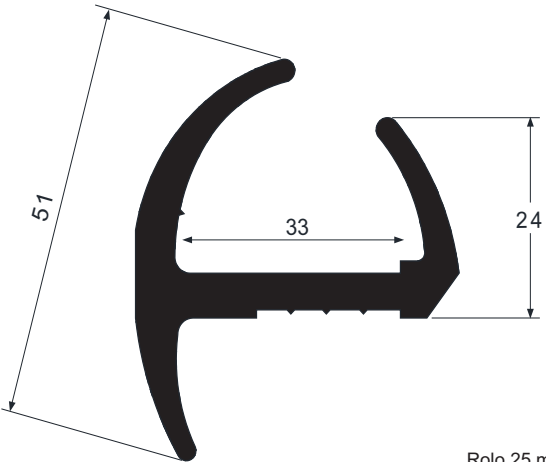
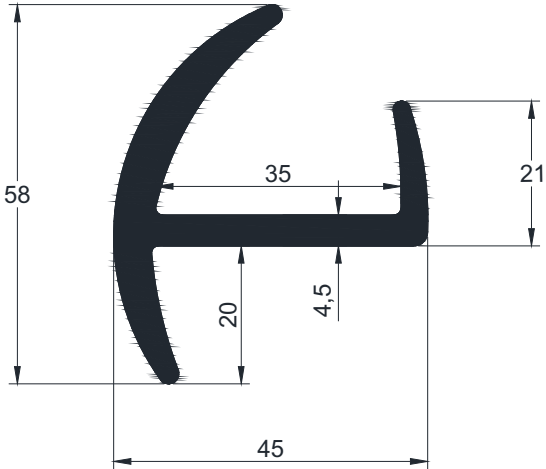
<p>IBC 3241 SBR 80 Sh A Vedação Porta Container</p>  <p>Rolo 25 m</p>	<p>IBC 3409 SBR 80 Sh A Vedação Porta Container</p>  <p>Rolo 25 m</p>	<p>IBC 3205 SBR 80 Sh A IBC 3451 EPDM 80 Sh A Vedação Porta Container</p>  <p>Rolo 25 m</p>
<p>IBC 3279 SBR 80 Sh A Vedação Porta Container</p>  <p>Rolo 25 m</p>	<p>IBC 3578 EPDM 75 Sh A</p>  <p>Rolo 25 m</p>	<p>* ITEM NOVO</p>

* ITEM NOVO

IBC 3277 SBR 80 Sh A
Vedação Porta Container

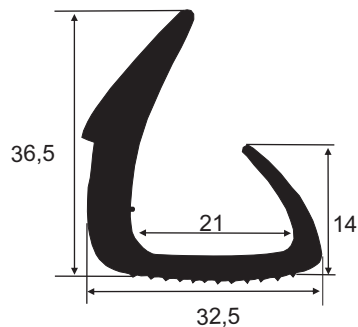

Rolo 25 m

IBC 3150 SBR 60 Sh A
Vedação Porta Container

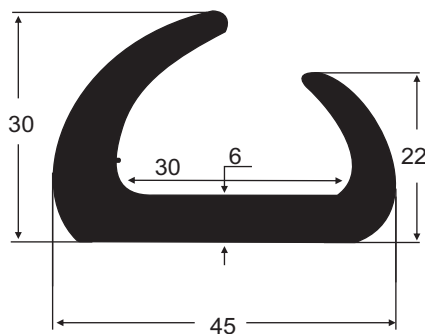

Rolo 25 m

IBC 3353 SBR 80 Sh A
Vedação Porta Container

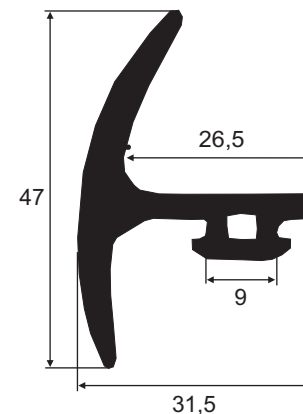

Rolo 25 m

IBC 3278 SBR 80 Sh A
Vedação Porta Container

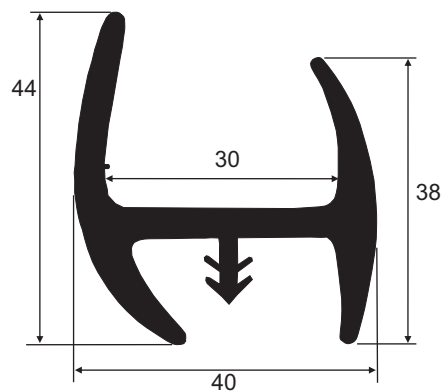

Rolo 25 m

IBC 3564 EPDM 75 Sh A

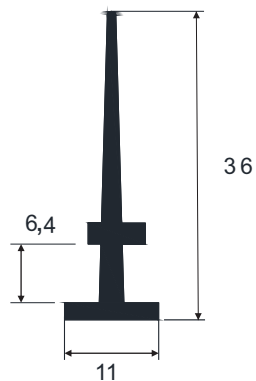

Rolo 25m

IBC 3383 EPDM 80 Sh A

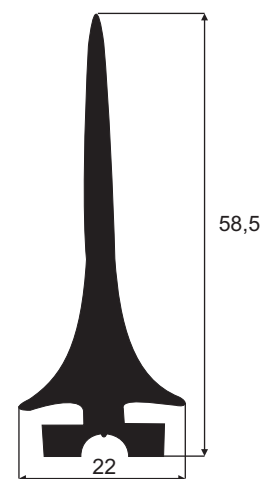

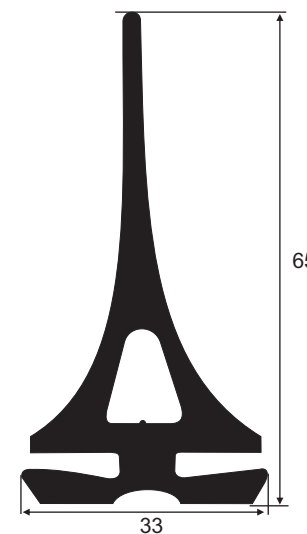

Rolo 25m

IBC 3445 EPDM 70 Sh A



Rolo 25m

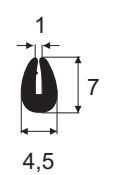
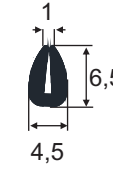
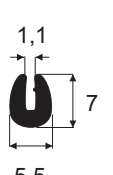
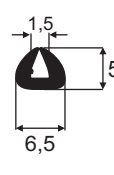
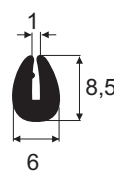
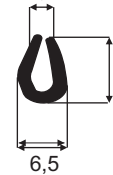
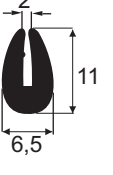
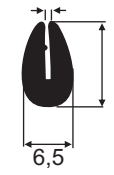
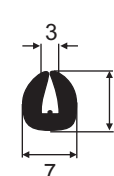
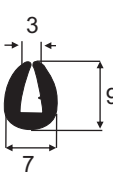

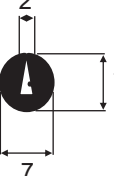
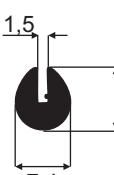
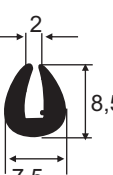
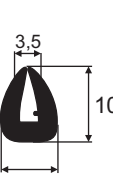
* ITEM NOVO

IBC 5013 SBR 70 Sh A IBC 5152 EPDM 70 Sh A  Rolo 100 m	IBC 5062 SBR 70 Sh A  Rolo 100 m	IBC 5084 EPDM 70 Sh A  Rolo 100 m	IBC 5069 SBR 70 Sh A  Rolo 100 m
IBC 5022 SBR 70 Sh A IBC 5128 EPDM 75 Sh A  Rolo 100 m	IBC 5158 EPDM 70 Sh A  Rolo 100 m	IBC 5054 SBR 70 Sh A  Rolo 100 m	IBC 5096 SBR 70 Sh A  Rolo 100 m
IBC 5024 SBR 70 Sh A  Rolo 100 m	IBC 5131 SBR 70 Sh A  Rolo 100 m	IBC 5025 SBR 70 Sh A  Rolo 100 m	IBC 5023 SBR 70 Sh A  Rolo 100 m
IBC 5016 SBR 70 Sh A  Rolo 100 m	IBC 5043 SBR 70 Sh A  Rolo 100 m	IBC 5068 SBR 70 Sh A  Rolo 100 m	

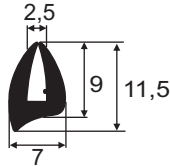
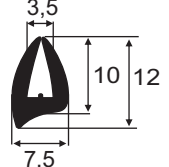
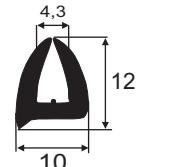
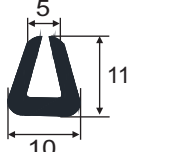
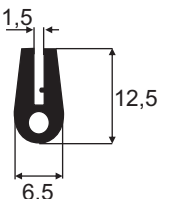
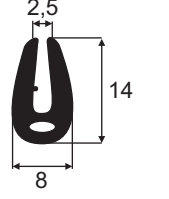
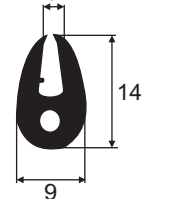
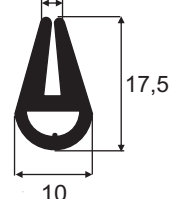
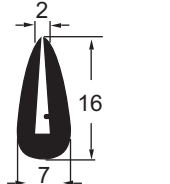
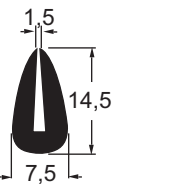
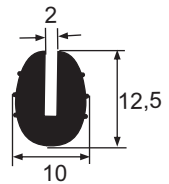
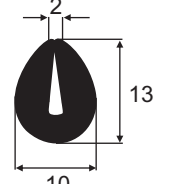
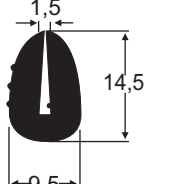
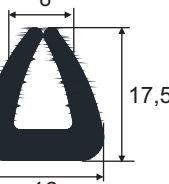
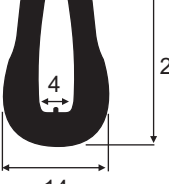



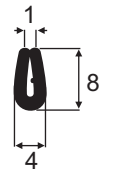
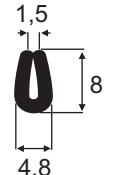
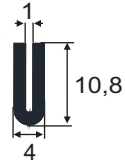

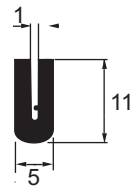
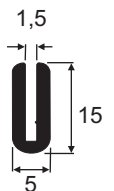
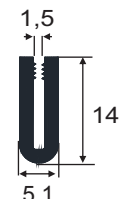
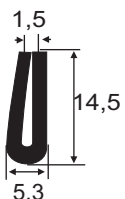
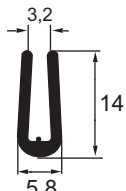
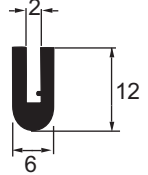
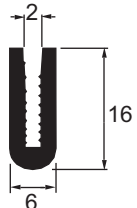
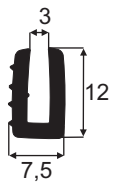
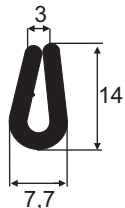
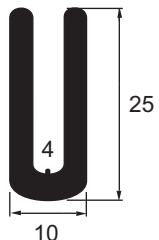
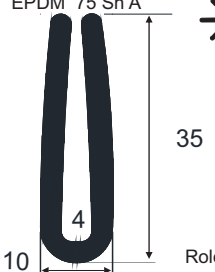
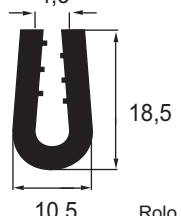
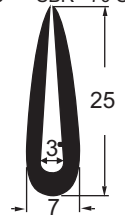
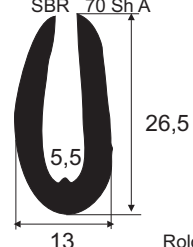
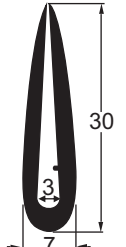
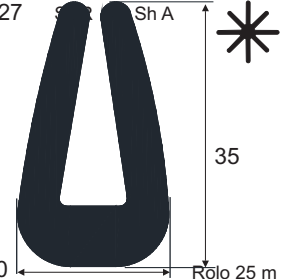



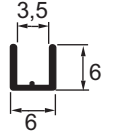
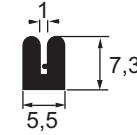
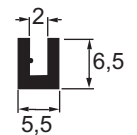
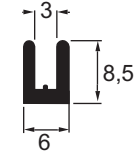
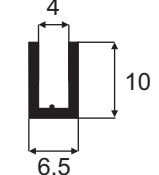
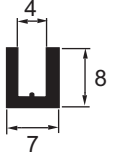
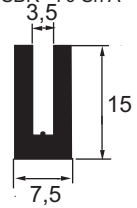
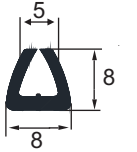
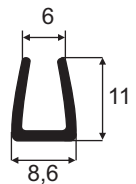

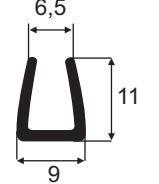
* ITEM NOVO

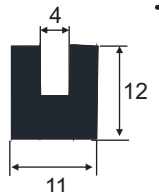
<p>IBC 5065 SBR 70 Sh A</p>  <p>Rolo 100 m</p>	<p>IBC 5066 SBR 70 Sh A</p>  <p>Rolo 100 m</p>	<p>IBC 5107 SBR 70 Sh A</p>  <p>Rolo 50 m</p>	<p>IBC 5175 NBR 70 Sh A</p>  <p>Rolo 50 m</p> <p style="text-align: right;">*</p>
<p>IBC 5076 EPDM 65 Sh A</p>  <p>Rolo 50 m</p>	<p>IBC 5081 SBR 65 Sh A Acab. Painel Marcopolo Alegro</p>  <p>Rolo 50 m</p>	<p>IBC 5058 EPDM 65 Sh A</p>  <p>Rolo 50 m</p>	<p>IBC 5009 EPDM 65 Sh A</p>  <p>Rolo 50 m</p>
<p>IBC 5072 SBR 70 Sh A</p>  <p>Rolo 50 m</p>	<p>IBC 5028 SBR 70 Sh A IBC 5161 EPDM 70 Sh A</p>  <p>Rolo 50 m</p>	<p>IBC 5041 SBR 70 Sh A</p>  <p>Rolo 50 m</p> <p style="text-align: right;">*</p>	<p>IBC 5163 SBR 70 Sh A</p>  <p>Rolo 50 m</p> <p style="text-align: right;">*</p>
<p>IBC 5070 SBR 70 Sh A</p>  <p>Rolo 50 m</p>	<p>IBC 5179 EPDM 75 Sh A</p>  <p>Rolo 25 m</p>	<p>IBC 5098 SBR 70 Sh A</p>  <p>Rolo 25 m</p>	

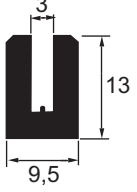
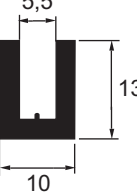
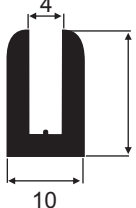
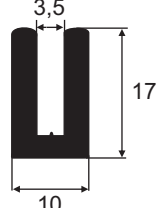
* ITEM NOVO

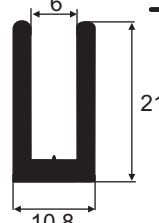
IBC 5002 SBR 70 Sh A  Rolo 100 m	IBC 5012 SBR 70 Sh A  Rolo 100 m	IBC 5184 EPDM 70 Sh A *  Rolo 100 m	IBC 5018 SBR 70 Sh A  Rolo 100 m	IBC 5019 EPDM 70 Sh A  Rolo 100 m
IBC 5143 SBR 70 Sh A  Rolo 100 m	IBC 5183 EPDM 70 Sh A *  Rolo 100 m	IBC 5109 SBR 70 Sh A  Rolo 100 m	IBC 5080 EPDM 65 Sh A  Rolo 100 m	IBC 5005 SBR 70 Sh A IBC 5151 EPDM 70 Sh A  Rolo 100 m
IBC 5036 SBR 70 Sh A  Rolo 50 m	IBC 5141 EPDM 70 Sh A  Rolo 100 m	IBC 5136 SBR 70 Sh A  Rolo 50 m	IBC 5055 SBR 70 Sh A  Rolo 25 m	IBC 5174 EPDM 75 Sh A *  Rolo 50 m
IBC 5074 SBR 70 Sh A  Rolo 50 m	IBC 5026 SBR 70 Sh A  Rolo 50 m	IBC 5116 SBR 70 Sh A  Rolo 25 m	IBC 5027 SBR 70 Sh A  Rolo 50 m	IBC 5027 SBR 70 Sh A *  Rolo 25 m

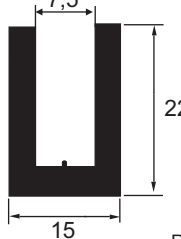
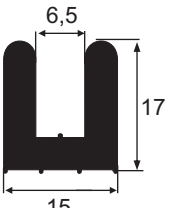
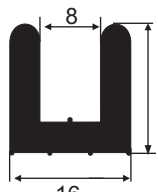

* ITEM NOVO

IBC 5037 SBR 70 Sh A  Rolo 100 m	IBC 5051 SBR 70 Sh A  Rolo 100 m	IBC 5042 SBR 70 Sh A  Rolo 100 m	IBC 5039 SBR 70 Sh A  Rolo 100 m	IBC 5046 SBR 70 Sh A  Rolo 100 m
IBC 5056 SBR 70 Sh A  Rolo 100 m	IBC 5038 SBR 70 Sh A  Rolo 50 m	IBC 5010 SBR 70 Sh A  Rolo 100 m	IBC 5154 EPDM 70 Sh A   Rolo 50 m	IBC 5153 SBR 70 Sh A   Rolo 100 m
IBC 5171 NBR 65 Sh A   Rolo 50 m	IBC 5071 SBR 70 Sh A  Rolo 50 m	IBC 5040 EPDM 65 Sh A  Rolo 50 m	IBC 5097 SBR 70 Sh A  Rolo 50 m	IBC 5164 SBR 70 Sh A   Rolo 50 m
IBC 5165 SBR 70 Sh A   Rolo 50 m	IBC 5045 SBR 70 Sh A  Rolo 25 m	IBC 5082 SBR 70 Sh A  Rolo 25 m	IBC 5083 SBR 70 Sh A IBC 5126 NBR 70 Sh A   Rolo 25 m	

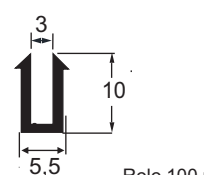
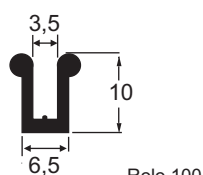
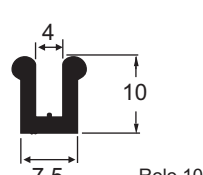
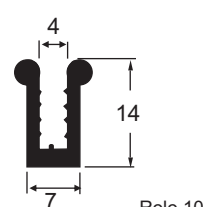
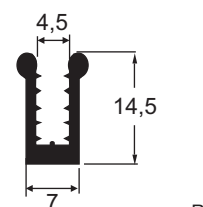
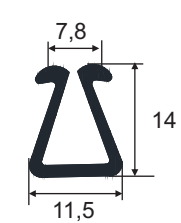
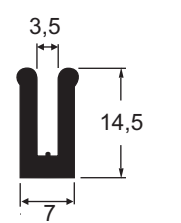
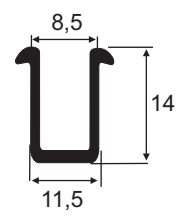
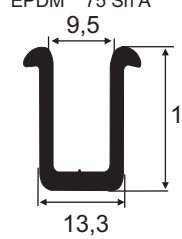
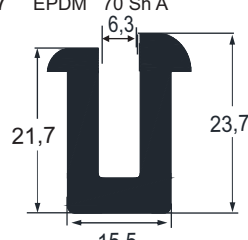
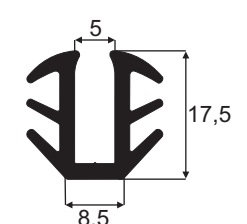
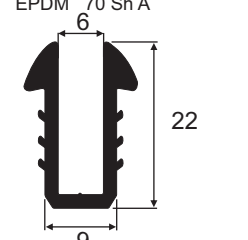
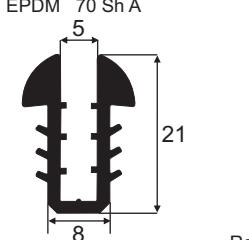
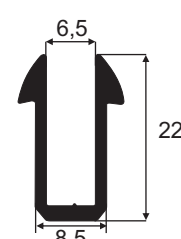
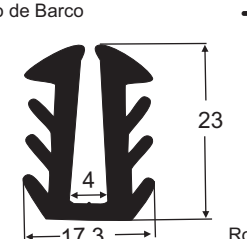
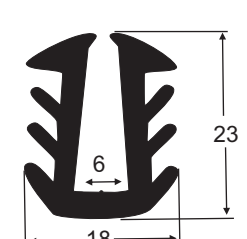
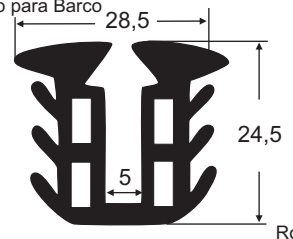

 ITEM NOVO

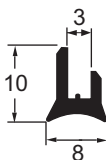
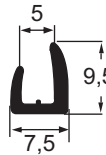
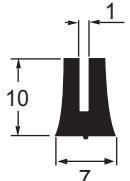
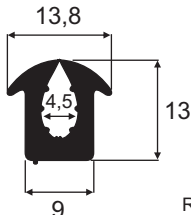
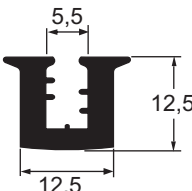
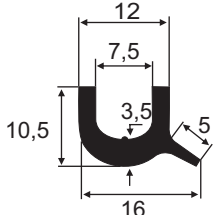
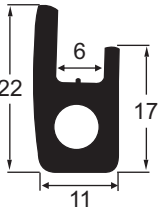
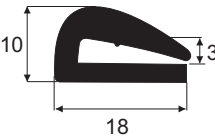
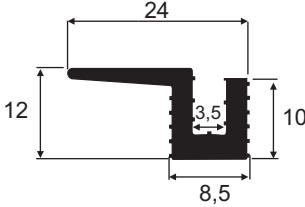
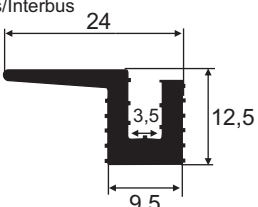
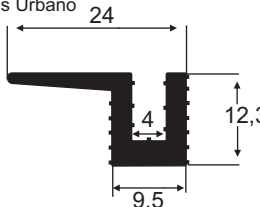
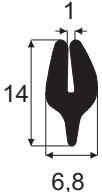
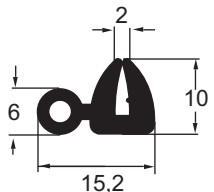
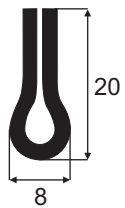
<p>IBC 5050 SBR 70 Sh A</p>  <p>Rolo 100 m</p>	<p>IBC 5020 SBR 70 Sh A</p>  <p>Rolo 100 m</p>	<p>IBC 5052 SBR 70 Sh A</p>  <p>Rolo 100 m</p>	<p>IBC 5021 SBR 70 Sh A</p>  <p>Rolo 100 m</p>	<p>IBC 5011 SBR 70 Sh A</p>  <p>Rolo 100 m</p>
<p>IBC 5172 EPDM 75 Sh A</p>  <p>Rolo 50 m</p>	<p>IBC 5031 SBR 70 Sh A</p>  <p>Rolo 100 m</p>	<p>IBC 5148 EPDM 75 Sh A</p>  <p>Rolo 50m</p>	<p>IBC 5145 EPDM 75 Sh A</p>  <p>Rolo 50 m</p>	
<p>IBC 5177 EPDM 70 Sh A</p>  <p>Rolo 25 m</p>	<p>IBC 5139 EPDM 70 Sh A</p>  <p>Rolo 50m</p>	<p>IBC 5146 EPDM 70 Sh A</p>  <p>Rolo 50 m</p>	<p>IBC 5140 EPDM 70 Sh A</p>  <p>Rolo 50 m</p>	
<p>IBC 5147 EPDM 70 Sh A</p>  <p>Rolo 50m</p>	<p>IBC 5167 EPDM 75 Sh A Vedação Vidro de Barco</p>  <p>Rolo 25 m</p>	<p>IBC 5169 EPDM 75 Sh A</p>  <p>Rolo 25 m</p>	<p>IBC 5168 EPDM 75 Sh A Vedação para Barco</p>  <p>Rolo 25 m</p>	

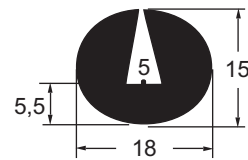
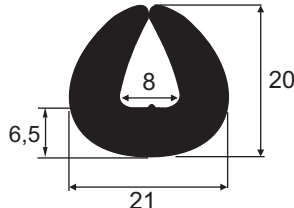
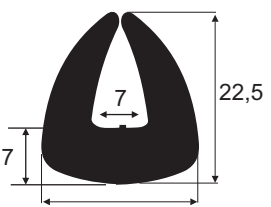
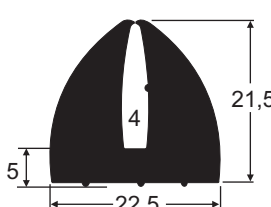
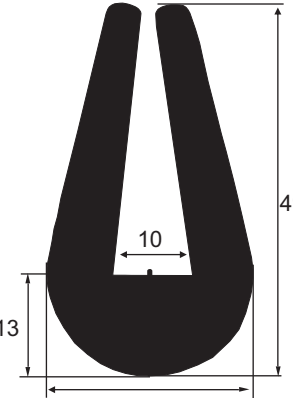
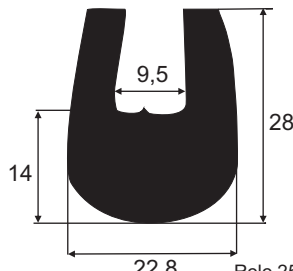
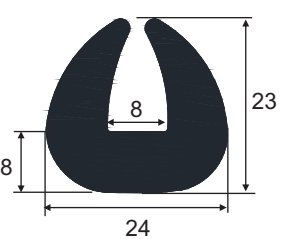
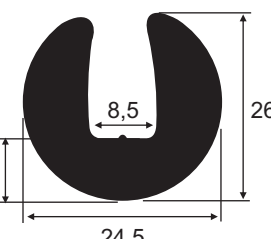
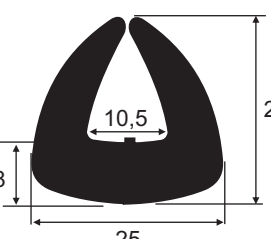
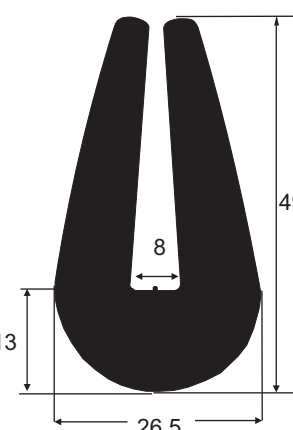
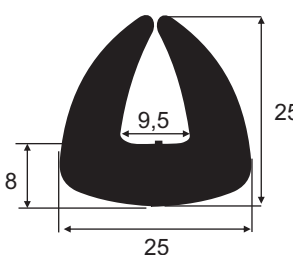
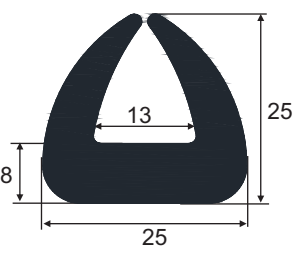
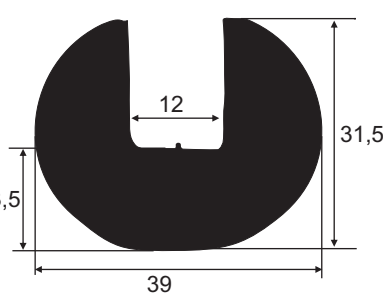
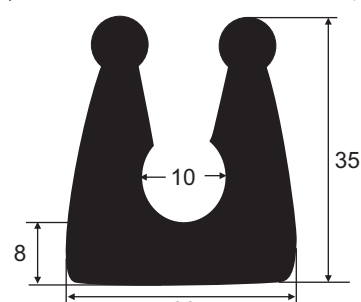
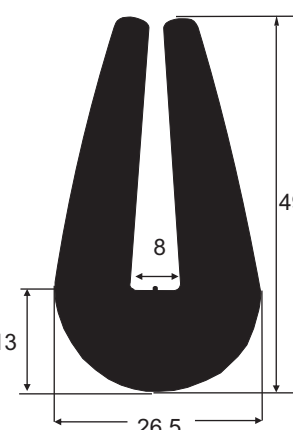

* ITEM NOVO

<p>IBC 5047 SBR 70 Sh A</p>  <p>Rolo 100 m</p>	<p>IBC 5044 SBR 70 Sh A</p>  <p>Rolo 100 m</p>	<p>IBC 5063 SBR 70 Sh A</p>  <p>Rolo 100 m</p>	<p>IBC 5015 SBR 70 Sh A</p>  <p>Rolo 100 m</p>
<p>IBC 5057 SBR 70 Sh A</p>  <p>Rolo 50 m</p>	<p>IBC 5053 SBR 70 Sh A</p>  <p>Rolo 50 m</p>	<p>IBC 5106 EPDM 70 Sh A</p>  <p>Rolo 50 m</p>	<p>IBC 5073 SBR 70 Sh A</p>  <p>Rolo 25 m</p>
<p>IBC 5156 SBR 70 Sh A</p>  <p>Rolo 50 m</p>	<p>IBC 5112 SBR 70 Sh A Ved. Entre vidros ônibus Busscar Urbanus, Interbus.</p>  <p>Rolo 25 m</p>	<p>IBC 5113 SBR 70 Sh A Ved. Entre vidros ônibus Neobus/Mega, Busscar Urbanus/Interbus</p>  <p>Rolo 25 m</p>	<p>IBC 5085 SBR 70 Sh A Vedação Entre Vidros Ônibus Marcopolo Metalbus Urbano</p>  <p>Rolo 25 m</p>
<p>IBC 5155 SBR 70 Sh A</p>  <p>Rolo 100 m</p>	<p>IBC 5077 SBR 60 Sh A</p>  <p>Rolo 50 m</p>	<p>IBC 5160 SBR 70 Sh A</p>  <p>Rolo 50 m</p>	<p></p>

 ITEM NOVO

<p>IBC 5035 SBR 70 Sh A</p>  <p>Rolo 25 m</p>	<p>IBC 5103 SBR 70 Sh A Vedação de Peneiras de Mineração</p>  <p>Rolo 25 m</p>	<p>IBC 5115 EPDM 70 Sh A</p>  <p>Rolo 25 m</p>	<p>IBC 5138 SBR 70 Sh A Proteção Máquinas Calçados</p>  <p>Rolo 25 m</p>	<p>IBC 5087 SBR 70 Sh A IBC 5157 EPDM 70 Sh A Vedação de Peneiras para Mineração</p>  <p>Rolo 25 m</p>
<p>IBC 5123 SBR 80 Sh A</p>  <p>Rolo 25 m</p>	<p>IBC 5181 SBR 70 Sh A</p>  <p>Rolo 25 m</p>	<p>IBC 5129 SBR 70 Sh A</p>  <p>Rolo 25 m</p>	<p>IBC 5104 SBR 70 Sh A</p>  <p>Rolo 25 m</p>	<p>IBC 5108 SBR 70 Sh A Vedação Peneiras para Mineração IBC 5173 EPDM 70 Sh A OBS: Largura da base 26,5mm</p>  <p>Rolo 25 m</p>
<p>IBC 5105 SBR 70 Sh A Vedação de Peneiras de Mineração</p>  <p>Rolo 25 m</p>	<p>IBC 5180 SBR 70 Sh A</p>  <p>Rolo 25 m</p>	<p>IBC 5119 SBR 70 Sh A</p>  <p>Rolo 25 m</p>	<p>IBC 5166 EPDM 75 Sh A - Separador Forma Pré Moldado</p>  <p>Rolo 25 m</p>	 <p>Rolo 25 m</p>

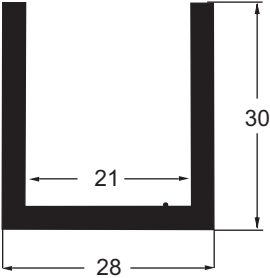
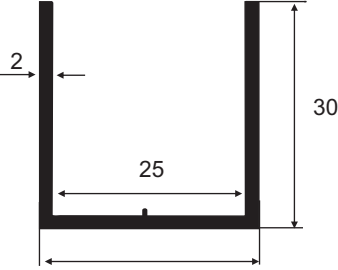
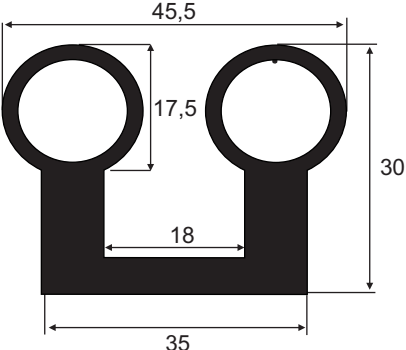
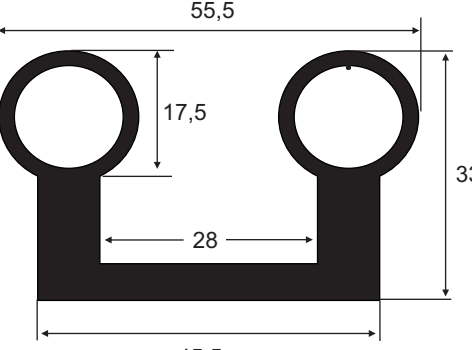
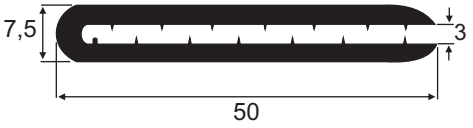
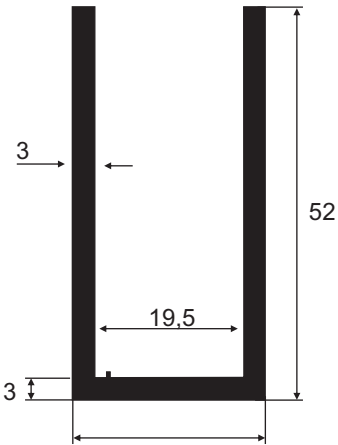
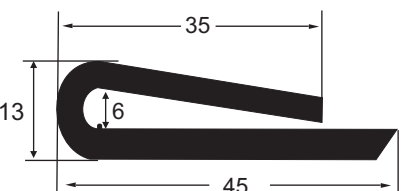
* ITEM NOVO

<p>IBC 5122 SBR 70 Sh A</p>  <p>Rolo 25 m</p>	<p>IBC 5120 EPDM 70 Sh A</p>  <p>Rolo 25 m</p>	<p>IBC 5159 EPDM 70 Sh A</p>  <p>Rolo 25 m</p>	<p>IBC 5121 EPDM 70 Sh A</p>  <p>Rolo 25 m</p>
<p>IBC 5060 SBR 80 Sh A</p>  <p>Rolo 25 m</p>	<p>IBC 5094 SBR 80 Sh A</p>  <p>Rolo 25 m</p>	<p>IBC 5048 EPDM 65 Sh A</p>  <p>Rolo 25 m</p>	
<p>IBC 5059 SBR 80 Sh A</p>  <p>Rolo 25 m</p>			

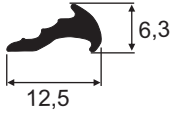
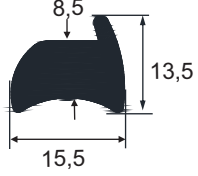
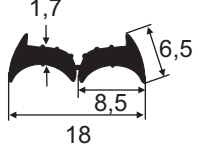
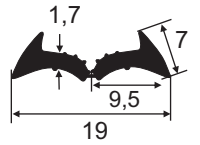
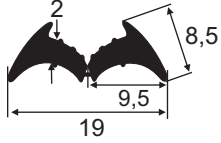
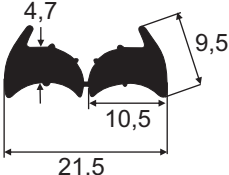
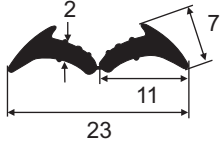
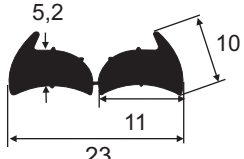
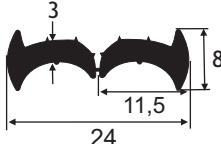
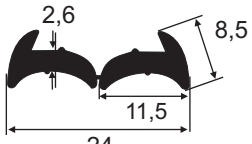
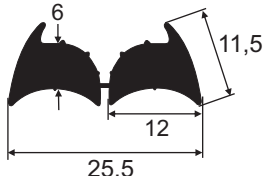
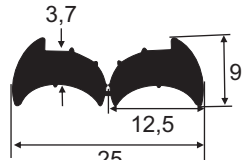
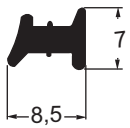
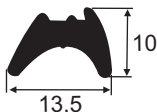
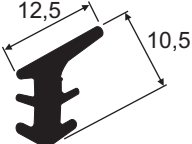

* ITEM NOVO

<p>IBC 5137 EPDM 75 Sh A</p>  <p>Rolo 100 m</p>	<p>IBC 5176 EPDM 70 Sh A</p>  <p>Rolo 50 m</p>	<p>IBC 5099 SBR 70 Sh A</p>  <p>Rolo 100 m</p>	<p>IBC 5003 EPDM 70 Sh A</p>  <p>Rolo 100 m</p>
<p>IBC 5006 EPDM 70 Sh A</p>  <p>Rolo 100 m</p>	<p>IBC 5034 EPDM 70 Sh A IBC 5102 SBR 70 Sh A</p>  <p>Rolo 100 m</p>	<p>IBC 5033 EPDM 70 Sh A IBC 5101 SBR 70 Sh A</p>  <p>Rolo 100 m</p>	<p>IBC 5150 EPDM 70 Sh A</p>  <p>Rolo 50 m</p>
<p>IBC 5032 EPDM 70 Sh A IBC 5100 SBR 70 Sh A</p>  <p>Rolo 100 m</p>	<p>IBC 5092 EPDM 70 Sh A</p>  <p>Rolo 100 m</p>	<p>IBC 5149 EPDM 70 Sh A</p>  <p>Rolo 50 m</p>	<p>IBC 5124 EPDM 70 Sh A IBC 5125 SBR 70 Sh A</p>  <p>Rolo 100 m</p>
<p>IBC 5001 SBR 70 Sh A</p>  <p>Rolo 100 m</p>	<p>IBC 5127 EPDM 70 Sh A</p>  <p>Rolo 100 m</p>	<p>IBC 5142 EPDM 75 Sh A</p>  <p>Rolo 100 m</p>	

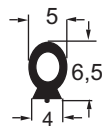
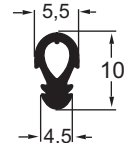
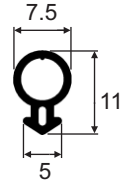
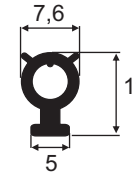
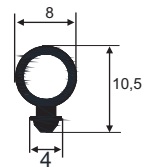
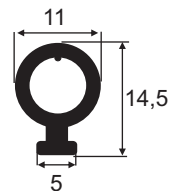
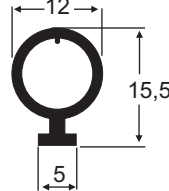
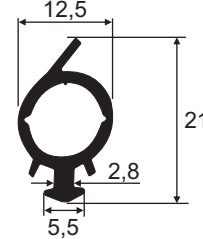
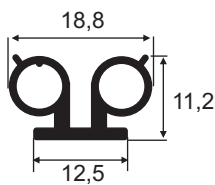
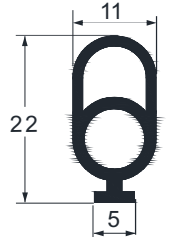
* ITEM NOVO

<p>IBC 5061 EPDM 70 Sh A</p>  <p>Rolo 50 m</p>	<p>IBC 5079 EPDM 70 Sh A</p>  <p>Rolo 100 m</p>	<p>IBC 5135 EPDM 70 Sh A Vedação Esquadrias</p>  <p>Rolo 50 m</p>	<p>IBC 5134 EPDM 70 Sh A</p>  <p>Rolo 100 m</p>
<p>IBC 5162 EPDM 70 Sh A</p>  <p>Rolo 50 m</p>	<p>IBC 5132 EPDM 70 Sh A</p>  <p>Rolo 50 m</p>	<p>IBC 5093 EPDM 70 Sh A</p>  <p>Rolo 50 m</p>	<p>IBC 5144 EPDM 75 Sh A</p>  <p>Rolo 50 m</p>
<p>IBC 5133 EPDM 70 Sh A</p>  <p>Rolo 50 m</p>	<p>IBC 5170 EPDM 70 Sh A</p>  <p>Rolo 50 m</p>		

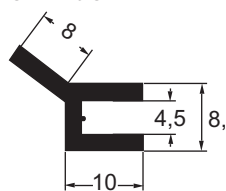
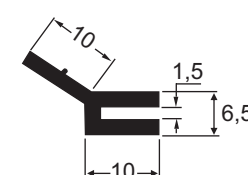
* ITEM NOVO

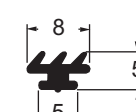
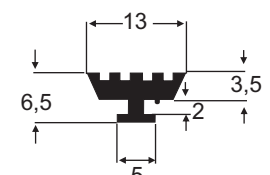
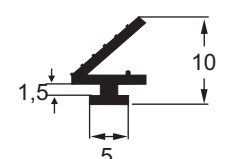
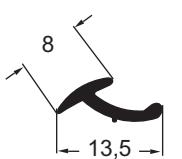
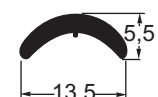
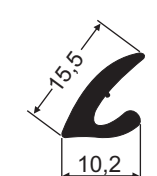
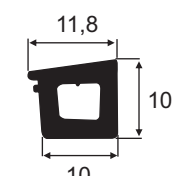
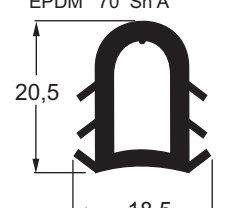

<p>IBC 5007 SBR 70 Sh A</p>  <p>Rolo 50 m</p>	<p>IBC 5008 SBR 70 Sh A</p>  <p>Rolo 100 m</p>	<p>IBC 5049 EPDM 70 Sh A</p>  <p>Rolo 50 m</p>	<p>IBC 5017 EPDM 70 Sh A</p>  <p>Rolo 50 m</p>
<p>IBC 5014 EPDM 70 Sh A</p>  <p>Rolo 100 m</p>	<p>IBC 5089 EPDM 70 Sh A</p>  <p>Rolo 100 m</p>	<p>IBC 5088 EPDM 70 Sh A</p>  <p>Rolo 100 m</p>	<p>IBC 5064 SBR 70 Sh A</p>  <p>Rolo 100 m</p>
<p>IBC 5004 SBR 70 Sh A</p>  <p>Rolo 100 m</p>	<p>IBC 5110 SBR 70 Sh A</p>  <p>Rolo 50 m</p>	<p>IBC 5130 EPDM 80 Sh A</p>  <p>Rolo 100 m</p>	<p>IBC 5111 EPDM 70 Sh A</p>  <p>Rolo 25 m</p>

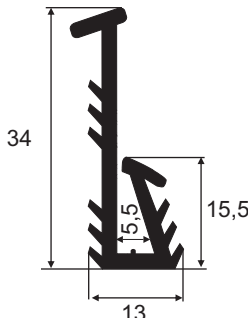
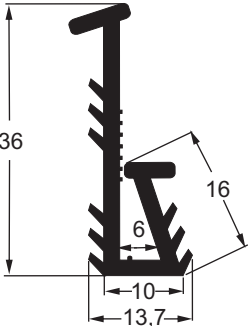
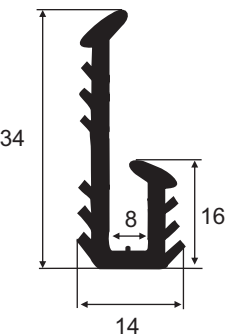
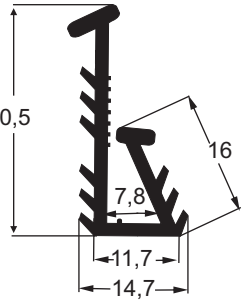
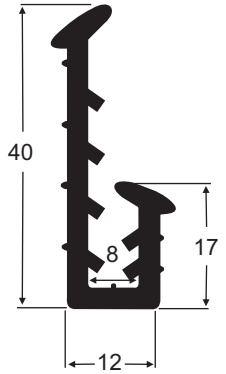
* ITEM NOVO

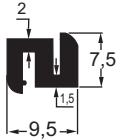
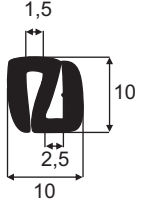
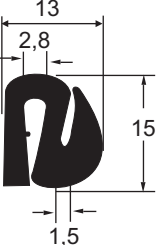
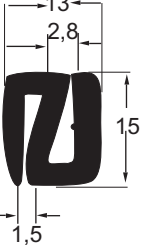
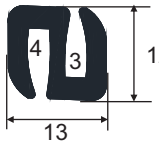
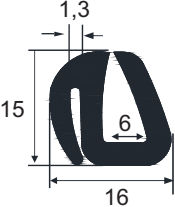
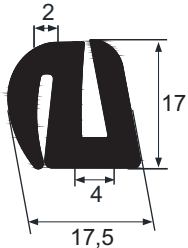
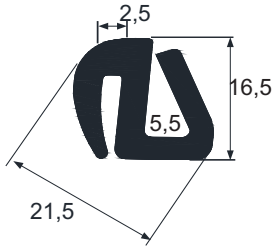
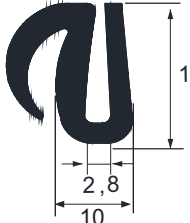
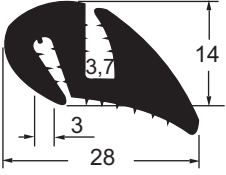
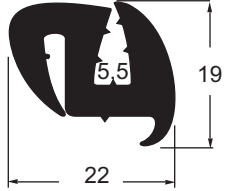
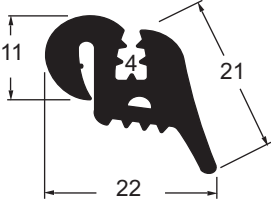
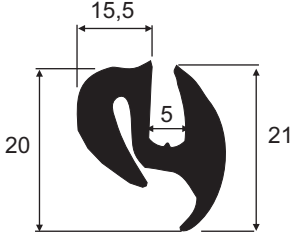
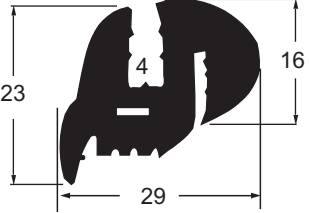
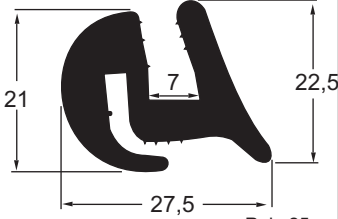
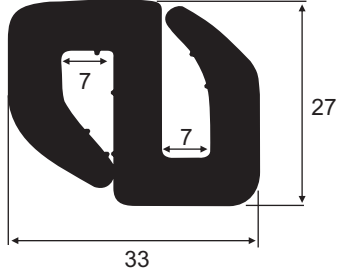
<p>IBC 5118 EPDM 70 Sh A</p>  <p>Rolo 25 m</p>	<p>IBC 5090 EPDM 70 Sh A</p>  <p>Rolo 25 m</p>	<p>IBC 5117 EPDM 70 Sh A</p>  <p>Rolo 25 m</p>	<p>IBC 5091 EPDM 70 Sh A</p>  <p>Rolo 25 m</p>
<p>IBC 5095 EPDM 70 Sh A</p>  <p>Rolo 25 m</p>			

<p>IBC 8018 SBR 70 Sh A</p>  <p>Rolo 50 m</p>	<p>IBC 8005 SBR 70 Sh A</p>  <p>Rolo 50 m</p>	<p>IBC 8038 SBR 70 Sh A</p>  <p>Rolo 50 m</p>	<p>IBC 8015 SBR 60 Sh A</p>  <p>Rolo 50 m</p>	<p>IBC 8085 NBR 65 Sh A</p>  <p>Rolo 50 m</p>	<p>IBC 8089 SBR 70 Sh A *</p>  <p>Rolo 50 m</p>
<p>IBC 8090 SBR 70 Sh A *</p>  <p>Rolo 50 m</p>	<p>IBC 8092 EPDM 80 Sh A *</p>  <p>Rolo 25 m</p>	<p>IBC 8086 SBR 70 Sh A *</p>  <p>Rolo 50 m</p>	<p>IBC 8013 SBR 70 Sh A</p>  <p>Rolo 25 m</p>	<p>IBC 8004 SBR 60 Sh A</p>  <p>Rolo 25 m</p>	
<p>IBC 8007 SBR 60 Sh A</p>  <p>Rolo 25 m</p>	<p>IBC 8054 SBR 60 Sh A</p>  <p>Rolo 25 m</p>	<p>IBC 8006 SBR 60 Sh A</p>  <p>Rolo 25 m</p>	<p>IBC 8010 SBR 60 Sh A</p>  <p>Rolo 25 m</p>	<p>IBC 8049 EPDM 70 Sh A</p>  <p>Rolo 25 m</p>	

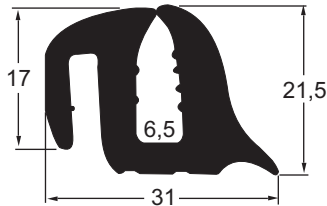
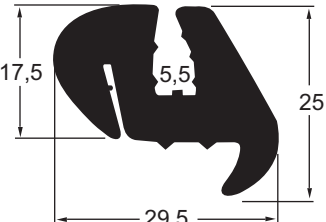
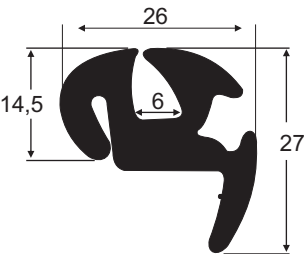
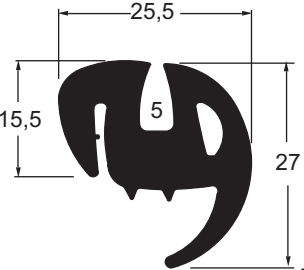
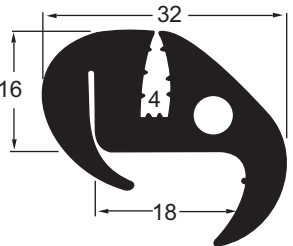
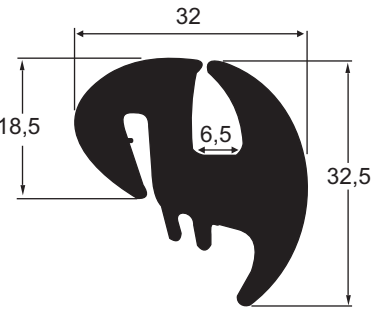
* ITEM NOVO

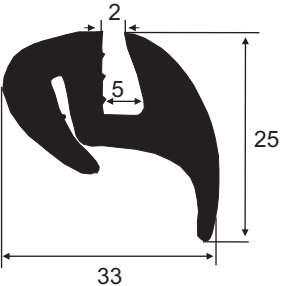
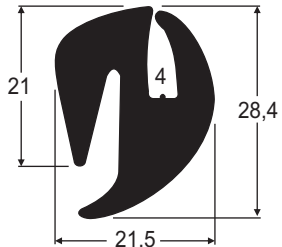
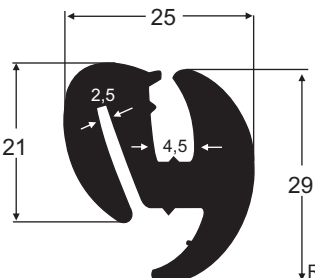
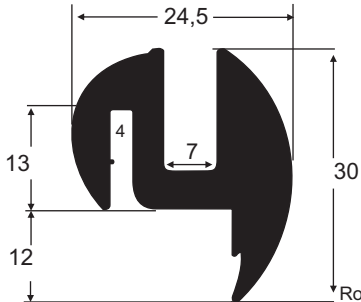
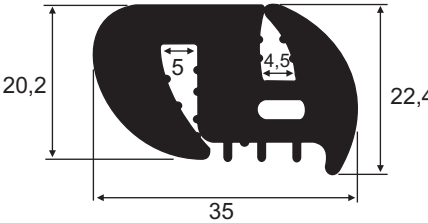
<p>IBC 8027 EPDM 60 Sh A Guarnição Vidro Colheitadeira</p>  <p>Rolo 25 m</p>	<p>IBC 8019 SBR 60 Sh A Vigia do Mercedes Benz</p>  <p>Rolo 25 m</p>	<p>IBC 8030 SBR 60 Sh A Vigia Central Scania</p>  <p>* Cunha 3101 Rolo 25 m</p>	<p>IBC 8008 SBR 60 Sh A PB/VG Chevette</p>  <p>Rolo 25 m</p>
<p>IBC 8026 EPDM 60 Sh A Vidro Porta San Marino</p>  <p>Rolo 25 m</p>	<p>IBC 8028 SBR 60 Sh A</p>  <p>Rolo 25 m</p>	<p>IBC 8076 SBR 60 Sh A</p>  <p>Rolo 25 m</p>	<p>IBC 8057 SBR 60 Sh A</p>  <p>Rolo 25 m</p>
<p>IBC 8046 SBR 60 Sh A</p>  <p>Rolo 25 m</p>	<p>IBC 8045 SBR 70 Sh A</p>  <p>Rolo 25 m</p>	<p>IBC 8043 EPDM 60 Sh A</p>  <p>Rolo 25 m</p>	<p>IBC 8077 SBR 60 Sh A</p>  <p>Rolo 25 m</p>

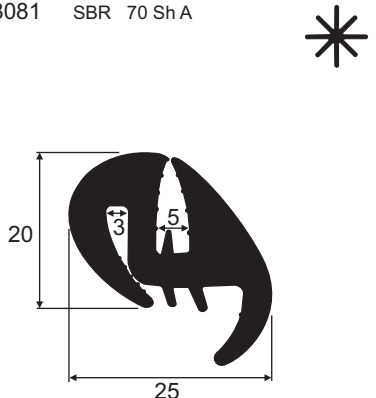
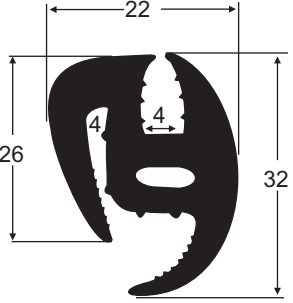
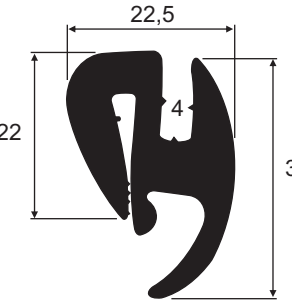
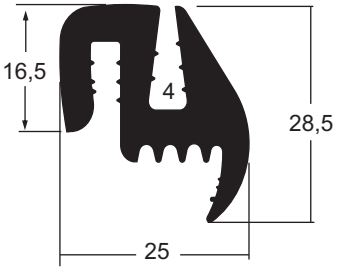
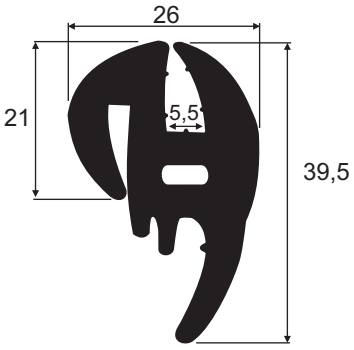
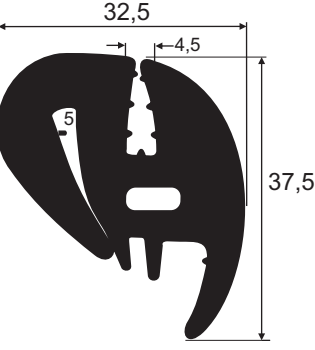
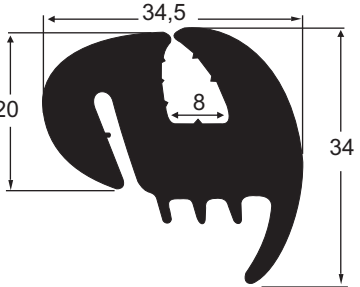
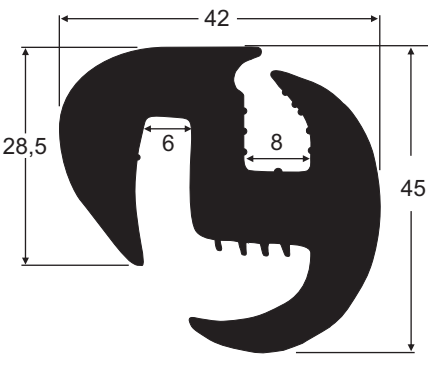
<p>IBC 8081 SBR 70 Sh A</p>  <p>Rolo 25m</p>	<p>IBC 8041 SBR 60 Sh A</p>  <p>Rolo 25 m</p>	<p>IBC 8070 SBR 60 Sh A</p>  <p>Rolo 25 m</p>	<p>IBC 8012 SBR 60 Sh A</p>  <p>Rolo 25 m</p>
<p>IBC 8020 SBR 70 Sh A Parabrisa Mercedes Ben Cabine Alta 75/89</p>  <p>Rolo 25 m</p>	<p>IBC 8021 SBR 60 Sh A Parabrisa MB - HPN - FPN</p>  <p>Rolo 25 m</p>	<p>IBC 8029 SBR 60 Sh A</p>  <p>Rolo 25 m</p>	<p>IBC 8024 EPDM 70 Sh A Guarnição Pára-brisa San Marino</p>  <p>Rolo 25 m</p>

* ITEM NOVO

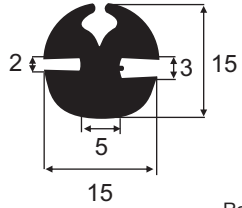
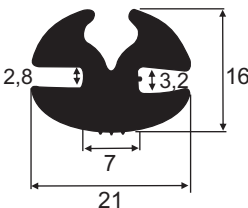
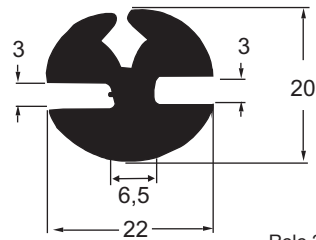
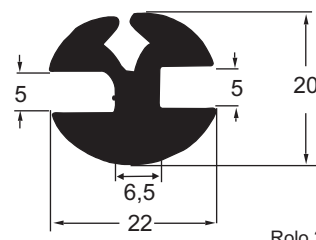
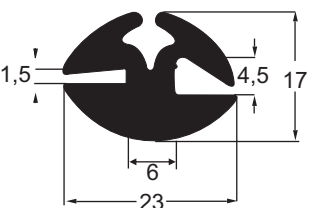
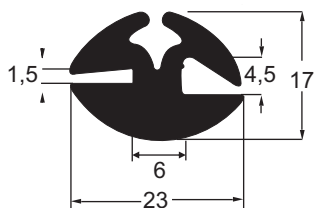
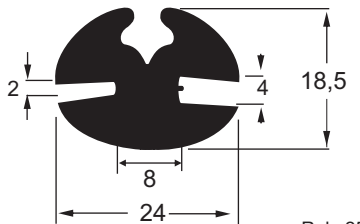
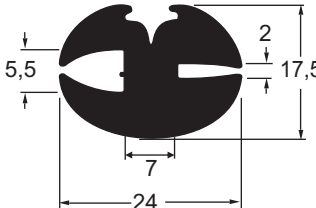
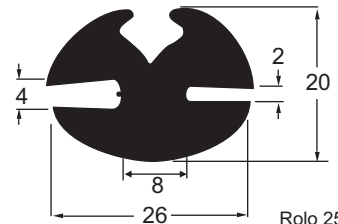
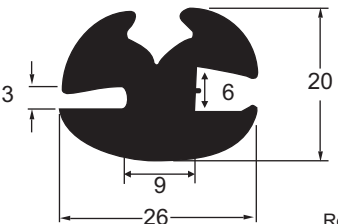
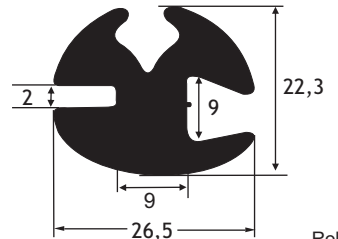
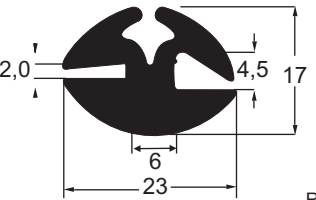
<p>IBC 8034 SBR 60 Sh A Cunha 3102</p>  <p>Rolo 50 m</p>	<p>IBC 8058 SBR 60 Sh A Cunha 3101</p>  <p>Rolo 25 m</p>	<p>IBC 8011 SBR 60 Sh A Cunha 3101</p>  <p>Rolo 25 m</p>	<p>IBC 8073 NBR 65 Sh A Cunha 3314</p>  <p>Rolo 25 m</p>
<p>IBC 8001 SBR 60 Sh A Cunha 3102 IBC 8083 EPDM 65 Sh A Cunha 3460 IBC 8084 EPDM 60 Sh A</p>  <p>Rolo 25 m</p>	<p>IBC 8042 NBR 70 Sh A Cunha 3314 *</p>  <p>Rolo 25 m</p>	<p>IBC 8040 SBR 60 Sh A Cunha 3101</p>  <p>Rolo 25 m</p>	<p>IBC 8014 SBR 60 Sh A Cunha 3101</p>  <p>Rolo 25 m</p>
<p>IBC 8002 SBR 60 Sh A Cunha 3101 IBC 8078 EPDM 65 Sh A Cunha 3426</p>  <p>Rolo 25 m</p>	<p>IBC 8003 SBR 60 Sh A Cunha 3101 IBC 8091 EPDM 60 Sh A Cunha 3101 *</p>  <p>Rolo 25 m</p>	<p>IBC 8056 SBR 60 Sh A Cunha 3101</p>  <p>Rolo 25 m</p>	<p>IBC 8082 EPDM 70 Sh A Cunha 3460</p>  <p>Rolo 25 m</p>

* ITEM NOVO

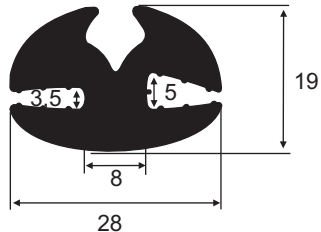
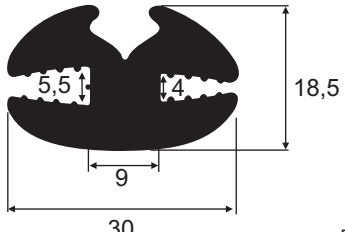
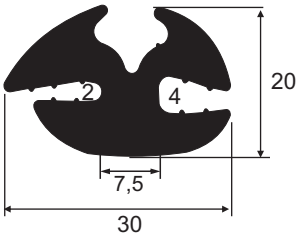
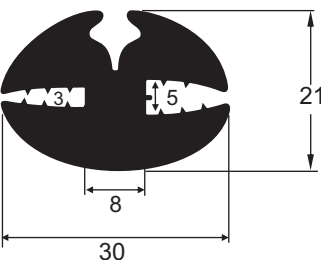
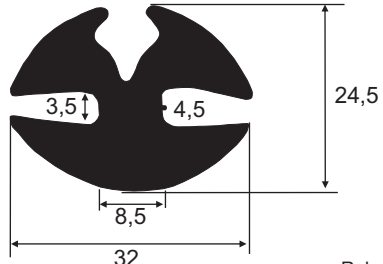
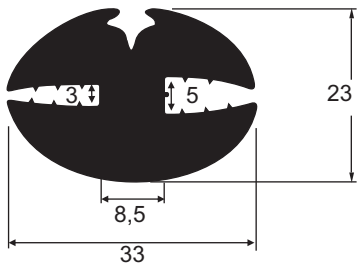
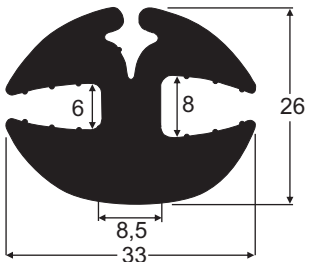
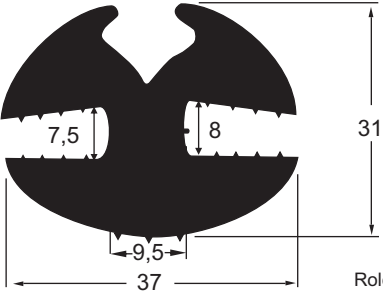
<p>IBC 8059 SBR 60 Sh A Cunha 3101</p>  <p>Rolo 25 m</p>	<p>IBC 8033 SBR 60 Sh A Cunha 3101</p>  <p>Rolo 25 m</p>	<p>IBC 8064 SBR 60 Sh A Cunha 3101</p>  <p>Rolo 25 m</p>
<p>IBC 8050 SBR 60 Sh A Cunha 3101</p>  <p>Rolo 25 m</p>	<p>IBC 8060 SBR 60 Sh A Cunha 3101</p>  <p>Rolo 25 m</p>	<p>IBC 8016 SBR 60 Sh A Cunha 3101</p>  <p>Rolo 25 m</p>
<p>IBC 8079 EPDM 70 Sh A Cunha 3426</p>  <p>Rolo 25 m</p>	<p>IBC 8017 SBR 60 Sh A Cunha 3119</p>  <p>Rolo 25 m</p>	<p></p>

* ITEM NOVO

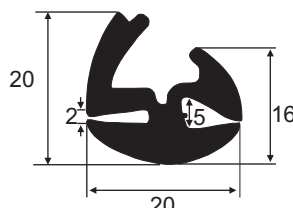
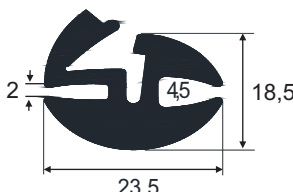
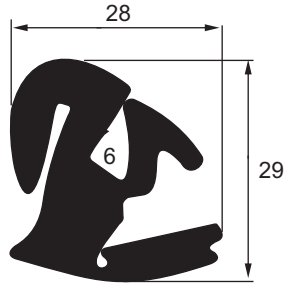
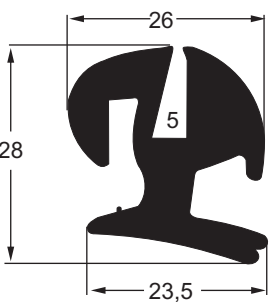
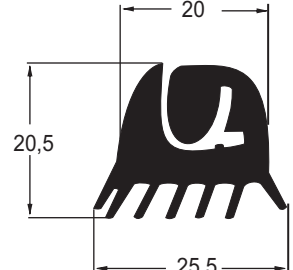
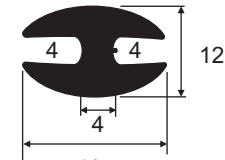
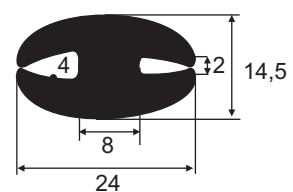
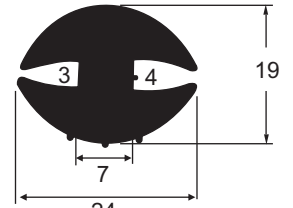
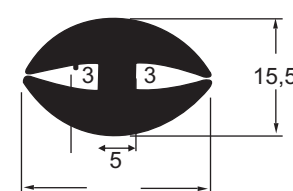
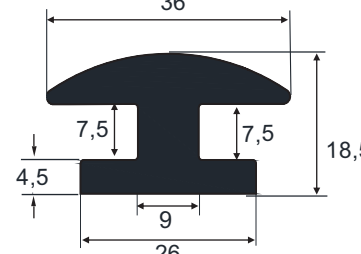
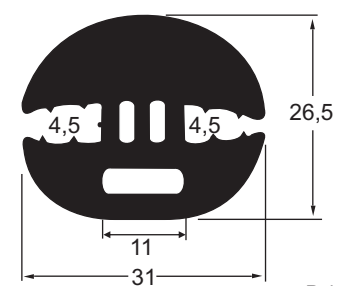
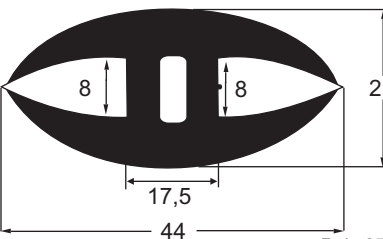
<p>IBC 8037 SBR 70 Sh A</p>  <p>Rolo 25 m</p>	<p>IBC 8088 SBR 65 Sh A</p>  <p>Rolo 25 m</p>	<p>IBC 8072 SBR 60 Sh A</p>  <p>Rolo 25 m</p>	<p>IBC 8044 SBR 70 Sh A</p>  <p>Rolo 25 m</p>
<p>IBC 8035 SBR 60 Sh A</p>  <p>Rolo 50 m</p>	<p>IBC 8071 SBR 70 Sh A</p>  <p>Rolo 25m</p>	<p>IBC 8067 SBR 60 Sh A</p>  <p>Rolo 25 m</p>	<p>IBC 8009 SBR 60 Sh A</p>  <p>Rolo 25 m</p>
<p>IBC 8036 SBR 70 Sh A</p>  <p>Rolo 25 m</p>	<p>IBC 8087 EPDM 70 Sh A</p>  <p>Rolo 32 m</p>	<p>IBC 8023 EPDM 60 Sh A</p>  <p>Rolo 25 m</p>	<p>IBC 8025 EPDM 60 Sh A</p>  <p>Rolo 25 m</p>

* ITEM NOVO

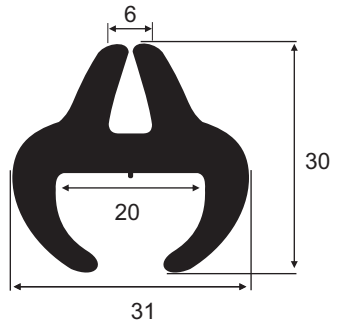
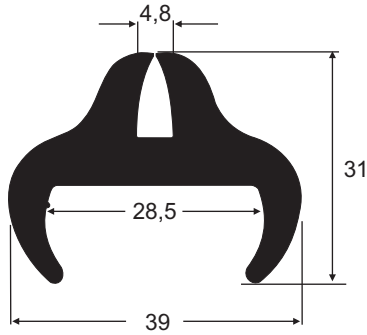
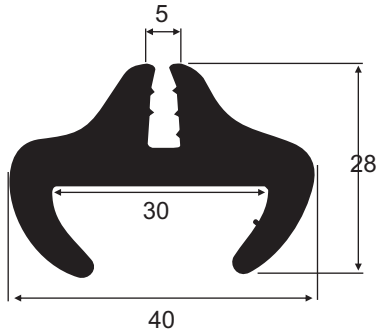
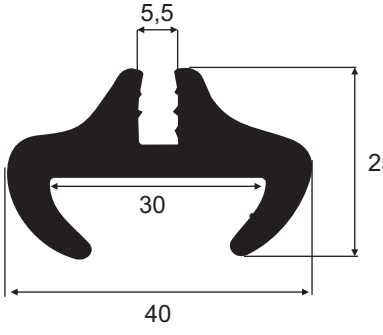
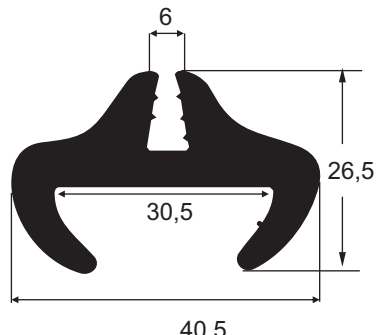
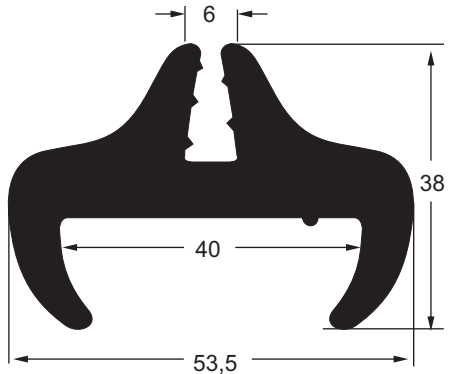
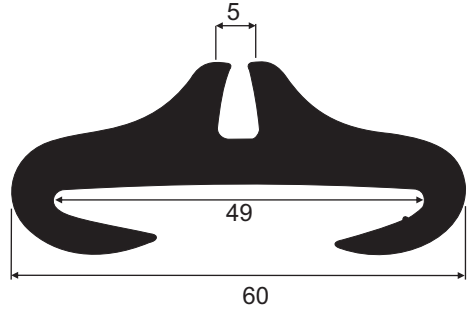
<p>IBC 8055 SBR 60 Sh A Vedação Cabine Máq. Agrícola/Ônibus</p>  <p>Rolo 25 m</p>	<p>IBC 8080 SBR 60 Sh A Vedação Lateral Cabine Trator *</p>  <p>Rolo 30 m</p>	<p>IBC 8062 SBR 70 Sh A IBC 8031 SBR 60 Sh A Vedação Cabine Máq. Agrícola/Ônibus</p>  <p>Rolo 25 m</p>	<p>IBC 8075 SBR 60 Sh A Vedação Cabine Máq. Agrícola/Ônibus</p>  <p>Rolo 25 m</p>
<p>IBC 8069 SBR 70 Sh A Vedação Cabine Máq. Agrícola/Ônibus</p>  <p>Rolo 25 m</p>	<p>IBC 8048 SBR 60 Sh A Vedação Cabine Máq. Agrícola/Ônibus</p>  <p>Rolo 25 m</p>	<p>IBC 8068 SBR 70 Sh A</p>  <p>Rolo 25 m</p>	

* ITEM NOVO

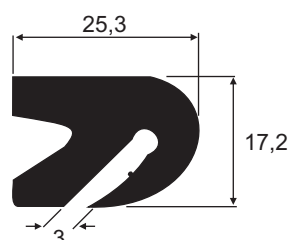
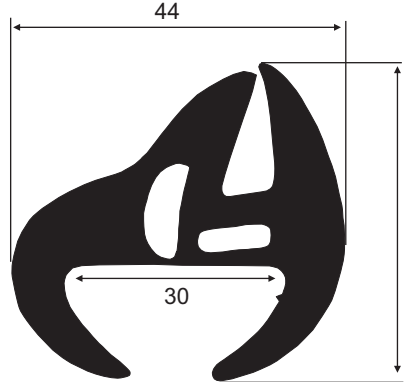
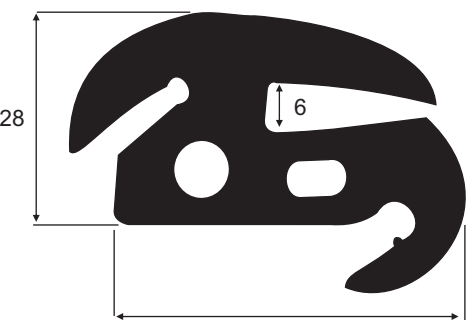
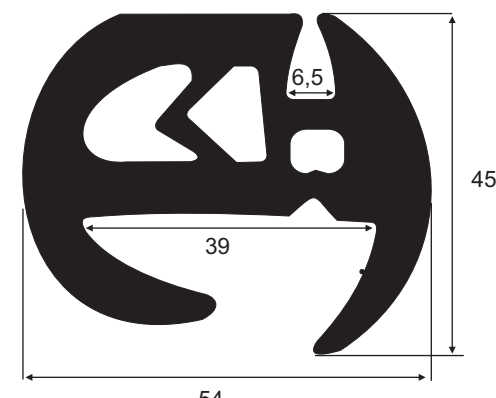
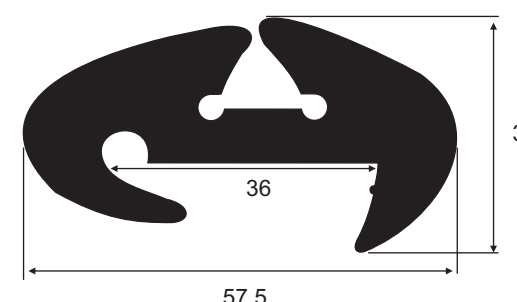
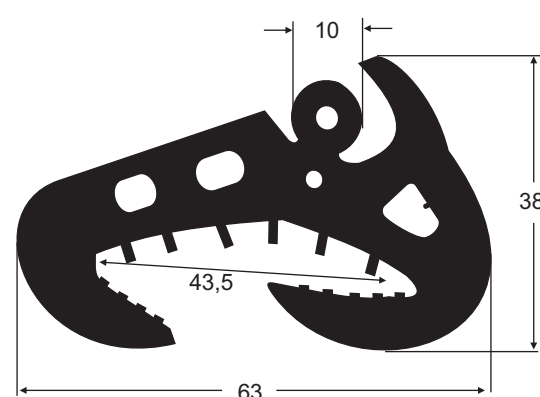
<p>IBC 8052 SBR 60 Sh A</p>  <p>Rolo 25 m</p>	<p>IBC 8061 EPDM 60 Sh A</p>  <p>Rolo 25 m</p>	<p>IBC8053 SBR 60 Sh A Vedação Cabine Máq. Agrícola</p>  <p>Rolo 25 m</p>
<p>IBC 8022 EPDM 70 Sh A Guarnição de Janela San Marino - Ônibus</p>  <p>Rolo 25 m</p>	<p>IBC 8051 SBR 60 Sh A Vedação Cabine Máq. Agrícola</p>  <p>Rolo 25 m</p>	<p>IBC 8039 EPDM 60 Sh A Janela Lateral Comil - Ônibus</p>  <p>Rolo 25 m</p>

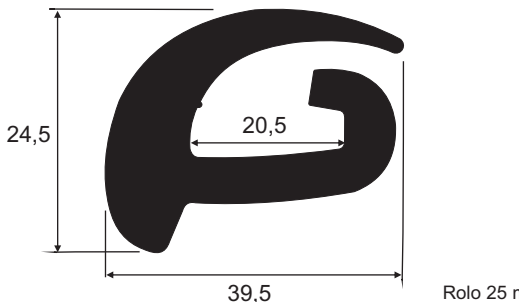
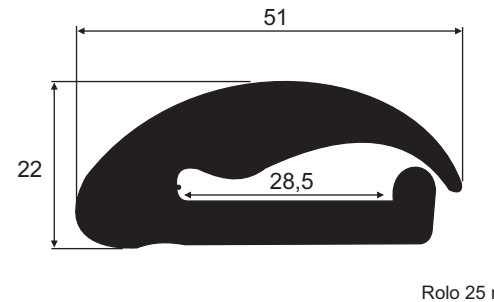
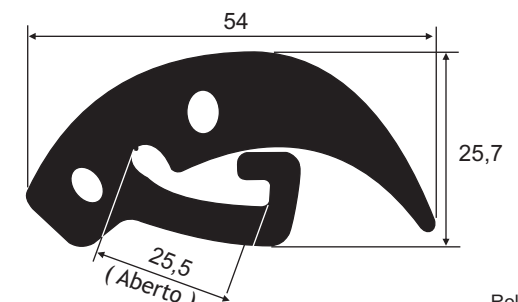
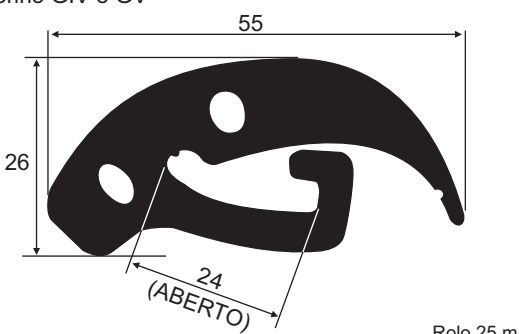
<p>IBC 8063 SBR 60 Sh A Aro de Roda Ônibus Neobus, MP Senior, MP Torino GV MP Rodoviário GV</p>  <p>Rolo 25 m</p>	<p>IBC 8032 SBR 60 Sh A Aro de Roda ônibus Caio, Comil, Metalbus e Thanco</p>  <p>Rolo 25 m</p>	<p>IBC 8065 SBR 60 Sh A Aro de Roda ônibus MP Rodov. Torino GIV</p>  <p>Rolo 25 m</p>
<p>IBC 8066 SBR 60 Sh A Aro de Roda Ônibus Ciferal Padron, MP Rodov GIV, Torino GIV e GV</p>  <p>Rolo 25 m</p>		